



BEAUTY & RETAIL

garysworkwear.com

BEAUTY & RETAIL

Proponiamo una collezione completa per il settore parrucchieri, estetica, benessere e addetti alla vendita che forniscono assistenza e consulenza in prima linea ai clienti, dove trasmettere una buona immagine è fondamentale.

Crea il tuo stile con noi, la qualità dei nostri tessuti è sempre una scommessa sicura e l'innovazione del design il nostro impegno quotidiano.

La nuova collezione BEAUTY & RETAIL di uniforme Gary's è un autentico viaggio tra colori, stili e outfit.

Apri il catalogo e goditi il viaggio.

Nous proposons une collection complète pour les secteurs de la coiffure, de la beauté, du bien-être et du commerce de détail, qui apportent des soins et des conseils de première ligne aux clients et c'est là que la transmission d'une bonne image est la clé. Créez votre style avec nous ;

La qualité de nos tissus est toujours notre valeur sûre et l'innovation dans les créations notre engagement quotidien.

La nouvelle collection BEAUTY & RETAIL de Gary's Uniforms est un tour authentique de couleurs, de styles et de outfits.

Ouvrez ce catalogue et profitez du voyage.



INDICE



RIF/RÉF.	PAG.
◆ 100003	92
◆ 100004	90
116500	99
● 200029	70
▲ 200031	72
● 200032	67
● 200034	65
▲ 200035	74
● 200036	66
● 200037	68
▲ 200038	75
● 200039	69
▲ 200043	76
▲ 200044	73
▲ 200045	78
▲ 200046	81
◆ 200047	71
◆ 200048	71
◆ 202300	113
◆ 203500	113
● 203600	113
■ 203900	113
312200	114

RIF/RÉF	PAG.
◆ 350001	97
◆ 350002	95
◆ 350300	96
390001	88
390002	88
390003	88
390004	88
● 550006	52
● 552800	63
◆ 596900	98
● 600021	37
● 600022	21
● 600023	22
▲ 600024	40
● 600025	31
● 600026	33
● 600027	54
● 600028	56
■ 600029	59
● 600031	24
● 600032	8
● 600033	4
● 600035	31
▲ 600036	38
■ 600037	46
■ 600039	45
■ 600041	61
■ 600042	60
◆ 600054	86
◆ 600055	6
● 600056	28
● 600057	7
● 600058	13
● 600059	54
● 600061	26
● 610600	10
● 610900	18
● 634700	62
● 634800	14
● 635500	12
● 635800	3
■ 651600	50

REF.	PAG.
● 652200	9
● 652500	17
■ 652600	51
● 652800	5
● 652900	18
● 653200	10
● 653500	2
● 700016	111
● 700018	112
● 700021	112
● 700024	111
▲ 700033	109
● 700036	100
● 700037	36
▲ 700038	108
▲ 700039	42
● 700041	33
● 700042	103
● 700044	106
● 700045	102
▲ 700046	108
● 700047	101
● 700048	106
■ 700049	107
● 700051	110
■ 700052	105
● 700600	104
● 704700	103
● 704900	110
◆ 780200	109
◆ 780300	109
● 800041	57
● 850004	84
● 850005	83
● 850006	83
● 850007	84
● 850012	34
● 850023	85
● 850024	85
◆ 950008	93
■ 950011	48

- MICROFIBRA/MICROFIBRE
- MICROFIBRA 360/MICROFIBRE 360
- MICROFIBRA 360 VIGORÉ/MICROFIBRE 360 VIGORÉ
- MAGLIA CRÊPE SPESSA/POINT DE CRÊPE ÉPAIS
- CRÊPE/CREPE
- ▲ BAMBOLA/BAMBULA
- TESSUTO WOVEN/PLAT
- PEACH
- TESSUTO BIELASTICO/PLAT BIELASTIQUE
- X.LINEN
- STRECH
- ▲ TWILL/SERGE
- MAGLIA FINE/POINTE FINE
- ◆ TWILL ELASTICO/SERGE ÉLASTIQUE
- ◆ DENIM/JEAN
- ◆ TESSUTO MAROCAINE/PLAT MARROQUINE
- ◆ INTERLOCK/POINT INTERLOCK

MICROFIBRA

MICROFIBRE

148 gr/m² - 100%PES

Antibatterico
Repelle capelli e liquidi
Alta traspirabilità
Non richiede stiratura
Nessuna alterazione del colore o del disegno
Tolleranza agli schizzi di
candeggina
Asciugatura rapida
Lavaggio a 90 °C

*Antibactérien
Repousse les cheveux et les liquides
Haute respirabilité
Pas besoin de fer à repasser
Les couleurs et les motifs ne sont pas altérés
Tolérance aux projections d'eau de
Javel
Séchage rapide*

BLUSE
BLOUSES



653500
FORMENTERA

XS-XXL
MICROFIBRA
MICROFIBRE
148 gr/m²
100%PES

C/001 Nero Noir
C/101 Bianco Blanc



635800
CINTA

XS-YL
MICROFIBRA
MICROFIBRE
148 gr/m²
100%PES

C/001 Nero Noir
C/101 Bianco Blanc



600033
ALHELÍ
XS-XXL
MICROFIBRA
MICROFIBRE
148 gr/m²
100%PES

C/101 Bianco Bianco





652800
CUBA

XS-YL
MICROFIBRA
MICROFIBRE
148 gr/m²
100%PES

C/101 Blanco-Blanc
C/001 Nero-Noir





600055
FICUS
XS-XXL
MICROFIBRA
MICROFIBRE
148 gr/m²
100%PES

C/001 Nero Noir



600057
TIACA
XS-XXL
MICROFIBRA
MICROFIBRE
148 gr/m²
100%PES

C/001 Nero Noir

600032
LANTANA

XS-XXL
MICROFIBRA
MICROFIBRE
148 gr/m²
100%PES

C/101 Blanco *Blanco*
C/001 Nero *Nero*





652200
ELBA

XS-YL
MICROFIBRA
MICROFIBRE
148 gr/m²
100%PES

C/001 Nero Noir
C/101 Bianco Blanc



653200
MALDIVAS

DONNA FEMME

XS-YL

MICROFIBRA

MICROFIBRE

148 gr/m²

100%PES

C/139 Grigio Marengo *Gris anthracite*

C/001 NeroNoir

C/101 Bianco Blanc

610600
MILOS

UOMO HOMME

XS-YL

MICROFIBRA

MICROFIBRE

148 gr/m²

100%PES

C/001 Nero Noir

C/101 Bianco Blanc

C/139 Grigio Marengo *Gris anthracite*



635500
POPPY

XS-YL
MICROFIBRA
MICROFIBRE
148 gr/m²
100%PES

C/001 Nero Noir





600058
SILENE

XS-XXL
MICROFIBRA
MICROFIBRE
148 gr/m²
100%PES

C/001 Nero Noir



634800
BEGONIA

XS-XXL
MICROFIBRA
MICROFIBRE
148 gr/m²
100%PES

C/101 Bianco Bianco
C/127 Pistacchio Pistache
C/115 Turchese Turquoise
C/116 Arancione Orange



gary's WORKWEAR

**Vesti con sicurezza.
Lavora con comodità.**

Habillez-vous en toute confiance. Travaillez confortablement.





652500
CORCEGA

XS-XXL
MICROFIBRA
MICROFIBRE
148 gr/m²
100%PES

C/101 Bianco Bianco
C/142 Sabbia Sable

610900
MALLORCA

UOMO MAN
XS-YL
MICROFIBRA
MICROFIBRE
148 gr/m²
100%PES

C/001 Nero Noir
C/139 Grigio marengo Gris anthracite
C/101 Bianco Blanc
C/142 Sabbia Sable



652900
MENORCA

DONNA WOMAN
XS-YL
MICROFIBRA
MICROFIBRE
148 gr/m²
100%PES

C/001 Nero Noir
C/139 Grigio marengo Gris anthracite
C/101 Bianco Blanc
C/142 Sabbia Sable





MICROFIBRA 360
by **gary's** WORKWEAR

CON TRATAMIENTO
SILVADUR.
The Science of Intelligent Freshness
with SILVADUR Treatment

SILVADUR TM 930 FLEX ANTIBATTERICO/ANTIBACTÉRIEN

Con ioni d'argento
Fornisce protezione e freschezza

*Sur les ions argent
Fournit protection et fraîcheur*

170 gr/m² - 95%PES 5%EA

Assorbe e trattiene il sudore della pelle,
facilitando la traspirazione ed evaporazione
dell'umidità offrendo così una maggiore
freschezza.

*Il absorbe et retient la transpiration de la
peau, ce qui facilite la transpiration et l'éva-
poration de l'humidité, offrant ainsi une plus
grande fraîcheur.*





600022
PENSAMIENTO

XS-XXL
MICROFIBRA 360
MICROFIBRE 360
170 gr/m²
95%PES 5%EA

C/001 Nero Noir
C/101 Bianco Bianco
C/152 Blu grigiastro Bleu gris

600023
MAGNOLIA

XS-XXL
MICROFIBRA 360
MICROFIBRE 360
170 gr/m²
95%PES 5%EA

C/001 Nero Noir
C/152 Blu grigiastro Bleu gris
C/101 Bianco Blanc





600031

LIRIO

XS-XXL

MICROFIBRA 360

MICROFIBRE 360

170 gr/m²

95%PES 5%EA

C/001 Nero Noir

C/101 Bianco Blanc





garysworkwear.com



600061

BELEÑO

XS-XXL

MICROFIBRA 360

MICROFIBRE 360

170 gr/m²

95%PES 5%EA

C/101 Bianco Blanc

C/001 Nero Noir





600056
ÁLAMO

XS-XXL
MICROFIBRA 360
MICROFIBRE 360
170 gr/m²
95%PES 5%EA

C/001 Nero Noir

BEAUTY & RETAIL





MICROFIBRA 360
by **gary's** MODERN

VIGORÉ

170 gr/m² - 95%PES 5%EA

Il tessuto screziato viene spesso utilizzato con fibre di colori diversi in modo che il capo non abbia un'opacità piatta, ma abbia intensità più o meno marcate che gli conferiscono un aspetto simile al lino, e un carattere e un aspetto unici e attrattivi.

Elevata durata.
Elevata traspirabilità.
Morbidezza al tatto.
Elasticità.

Tissu chiné qui est généralement utilisé avec des fibres de différentes couleurs pour garantir que le vêtement n'a pas un ton plat, mais lui donne plutôt des intensités plus subtiles ou marquées, ce qui lui donne un aspect similaire à l'effet du lin, lui donnant un aspect très unique. caractère et apparence attrayants.

Grande durabilité.
Haute respirabilité.
Doux au toucher.
Élasticité.



600025
CAMPANILLA

XS-XXL
MICROFIBRA 360 VIGORÉ
MICROFIBRE 360 VIGORÉ
170 gr/m²
95%PES 5%EA

C/117 Grigio perla *Gris perle*



600035
ABEDUL

XS-XXL
MICROFIBRA 360 VIGORÉ
MICROFIBRE 360 VIGORÉ
170 gr/m²
95%PES 5%EA

C/117 Grigio perla *Pearl grey*



MAGLIA CREPE SPESSA

THICK CREPE KNIT

265 gr/m² - 95%PES 5%EA

Tessuto elastico e morbido.
Garantisce comfort e libertà di
movimento.

*Tissu très élastique et doux. Assure
confort et liberté de mouvement.*



600026

VEZA

XS-XXL

MAGLIA CREPE SPESSA

POINT CRÉPE ÉPAIS

265 gr/m²

95%PES 5%EA

C/001 Nero/Noir



700041

XS-XXL

MAGLIA CREPE SPESSA

POINT CRÉPE ÉPAIS

265 gr/m²

95%PES 5%EA

C/001 Nero/Noir



850012
ROBINIA

XS-XXL
MAGLIA CREPE SPESSA
POIN CRÉPE ÉPAIS
265 gr/m²
95%PES 5%EA

C/001 Nero Noir
C/110 Beige





garysworkwear.com

CREPÉ
CREPE

220 gr/m² - 97%PES 3%EA

Tessuto leggero e traspirante.
Asciugatura rapida.
Drappeggiante.
Piacevole al tatto.
Garantisce freschezza ed
eleganza allo stesso tempo.

*Tissu léger et respirable.
Séchage rapide.
Avec l'automne.
Agréable au toucher.
Il apporte fraîcheur et en même
temps élégance.*

700037

XS-XXL
CREPÉ
CREPE
220 gr/m²
97%PES 3%EA

C/001 Nero Noir



600021
ZULLA

XS-XXL
CREPÉ
CREPE
220 gr/m²
97%PES 3%EA

C/101 Bianco Bianco



BAMBULA

BAMBULA

160 gr/m² - 100%PES

Tessuto fresco e traspirante.
Piacevole al tatto e molto
resistente.
Aspetto con micro pieghe.

*Tissu très frais et transpirable.
Agréable au toucher et très résistant.
Aspect de très petits plis permanents*

600036

JARA

XS-XXL
BAMBULA
BAMBULA
160 gr/m²
100%PES

C/710 Beige





È UNA QUESTIONE
DI STILE

C'EST UNE QUESTION DE STYLE

gary's WORKWEAR

600024
PIMPINELA

XS-XXL
BAMBULA
BAMBULA
160 gr/m²
100%PES

C/157 Nude
C/110 Beige
C/154 Verde muschio Vert moussie





700039

XS-XXL
BAMBULA
BAMBULA
160 gr/m²
100%PES

C/157 Nude
C/110 Beige
C/154 Verde muschio Vert mousse



ESSERE ALLA MODA
AL LAVORO È UN MODO PER DISTINGUERSI

LA MODE DE TRAVAIL UNE MANIÈRE DE SE DÉMARQUER

gary's WORKWEAR



TESSUTO WOVEN

PLAT

220 gr/m² - 88%PES 12%EA

Tessuto molto piacevole.
I colori non cambiano dopo i lavaggi.
Elevata resistenza allo sfregamento.
Facile da stirare.
Asciugatura rapida.

*Tissu agréable et frais.
Les couleurs ne changent pas après lavage.
Grande résistance au pelage dû au frottement.
Repassage facile.
Séchage rapide.*





600039

MELI

XS-XXL
TESSUTO WOVEN
PLAT
220 gr/m²
88%PES 12%EA

C/169 Blu maya Bleu maya
C/110 Beige
C/001 Nero Noir



600037
ARABIS

XS-XXL
TESSUTO WOVEN
PLAT
220 gr/m²
88%PES 12%EA

C/110 Belge
C/169 Blu maya Bleu maya
C/001 Nero Noir





950011
MORERA

P-M-G-SG
TESSUTO WOVEN
PLAT
220 gr/m²
88%PES 12%EA

C/001 Nero Noir



651600
MADEIRA

XS-XXL
TESSUTO WOVEN
PLAT
120 gr/m²
86%PES 14%EA

C/001 Nero Noir



garysworkwear.com

652600
SAONA

XS-XXL
TESSUTO WOVEN
PLAT
120 gr/m²
86%PES 14%EA

C/001 Nero Noir



X.LINEN

195 gr/m² - 65%PES 30%VI
5%EA

Aspetto lino.
Forma elastica.
Traspirante.
Morbido al tatto.

*Aspect lin.
Forme élastique.
transpirable.
Doux au toucher.*



550006

XS-XXL
X-LINEN
195 gr/m²
65%PES 30%VI 5%EA

C/001 Nero *Navy*
C/157 Nude
C/104 Blu *Marrone*
C/110 Beige



600027
LOTO
DONNA FEMME
XS-XXL
X-LINEN
195 gr/m²
65%PES 30%VI 5%EA

C/001 Nero Noir
C/110 Beige
C/104 Blu Marino
C/157 Nude

600059
CICLAMEN

UOMO HOMME
XS-XXL
X-LINEN
195 gr/m²
65%PES 30%VI 5%EA

C/001 Nero Noir
C/110 Beige
C/104 Blu Marino



PEACH

125 gr/m² - 100%PES

Tecnologia che repelle schizzi
d'acqua e liquidi.
Alta traspirabilità.
Texture peach.
Finitura satinata.
Drappeggio ineguagliabile.

*Technologie qui empêche le
passage des projections d'eau et de
fluides.
Haute respirabilité
Texture peau de pêche. Satiné.
Chute inégale.*

600028
LIATRIS

XS-XXL
PEACH
125 gr/m²
100%PES

C/001 Nero Noir

IMPERMEABILE
HIDROFUGUE



800041
GIRASOL

XS-XXL
PEACH
125 gr/m²
100%PES

C/001 Nero /Noir

IMPERMEABILE
HIDROFUGE



TESSUTO BIELASTICO

PLAT BIÉLASTIQUE

120 gr/m² - 95%PES 5%EA

Tessuto elegante che mantiene la forma dopo il lavaggio senza perdere la sua adattabilità al movimento.

Altamente traspirante.

Asciugatura rapida.

Resistente allo sfregamento.

Drappeggio impareggiabile.

Tissu élégant qui conserve sa forme après le lavage sans perdre son adaptabilité au mouvement.

Très transpirable.

Séchage rapide.

Résistant à l'écaillage.

Chute inégalée.

gary's WORKWEAR





600029

BUGULA

XS-XXL

TESSUTO WOVEN

PLAT BIÉLASTIQUE

120 gr/m²

95%PES 5%EA

C/101 Bianco Blanc

C/001 Nero Noli



600042
CARDOTA

XS-XXL
TESSUTO WOVEN
PLAT BIÉLASTIQUE
120 gr/m²
95%PES 5%EA

C/101 Bianco White
C/001 Nero Black

600041

VINCA

XS-XXL

TESSUTO WOVEN

PLAT BIÉLASTIQUE

120 gr/m²

95%PES 5%EA

C/101 Bianco Bianco

C/001 Nero Noir



STRECH

165 gr/m² - 100%PES

Tessuto sintetico.
Asciugatura rapida.
Non richiede stiratura.
Tolleranza agli schizzi di candeggina.
Nessuna alterazione di colori o motivi.

*Tissu synthétique.
Séchage rapide
Aucun plâtrage n'est nécessaire.
Il tolère très bien les éclaboussures.
Les couleurs et les dessins ne sont pas
modifiés.*



634700
ADELFA

XS-YL
STRECH
165 gr/m²
100%PES

C/001 Nero Noir
C/641 Fragola Framboise
C/101 Bianco Blanc



552800
ANTÁRTIDA

XS-YL
STRECH
165 gr/m²
100%PES

C/101 Blanco Blanc
C/001 Nero Noir
C/641 Fragola Framboise

CASULE MICROFIBRA
MICROFIBRE CHASUBLES





200034
ASTER

TAGLIA UNICA TAILLE UNIQUE
MICROFIBRA
MICROFIBRE
148 gr/m²
100%PES

C/001 Nero NOIR





200036
TARAZA

TAGLIA UNICA TAILLE UNIQUE

MICROFIBRA

MICROFIBRE

148 gr/m²

100%PES

C/139 Grigio marengo Dark grey

C/142 Sabbia Sand



200032
BORBOLETA

TAGLIA UNICA TAILLE UNIQUE

MICROFIBRA

MICROFIBRE

148 gr/m²

100%PES

C/001 Nero Noir

garysworkwear.com



200037
DEDALERA

TAGLIA UNICA TAILLE UNIQUE

MICROFIBRA

MICROFIBRE

148 gr/m²

100% PES

C/001 Nero Noir





200039
CALCITA

TAGLIA UNICA, ONE SIZE
MICROFIBRA
MICROFIBRE
148 gr/m²
100%PES

C/104 Blu Marino



200029
LOBELIA

TAGLIA UNICA, TAILLE UNIQUE
MICROFIBRA
MICROFIBRE
148 gr/m²
100%PES

C/138 Fragola Framboise
C/101 Bianco Bianco



200047
AMAPOLA

TAGLIA UNICA TAILLE UNIQUE
DENIM
JEAN
160 gr/m²
98%CO 2%EA

C/834 Zaffiro Saphre

CASULE DENIM
JEAN CHASUBLES



200048
NARCISO

TAGLIA UNICA TAILLE UNIQUE
DENIM
JEAN
160 gr/m²
98%CO 2%EA

C/834 Zaffiro Saphir



CASULE SERGE
SERGE CHASUBLES



200031
NENÚFAR

TAGLIA UNICA TAILLE UNIQUE

SERGE

SERGE

208gr/m²

100%PES

C/001 Nero Bianco



200044
PROTEA

TAGLIA UNICA TAILLE UNIQUE

SERGE

SERGE

208gr/m²

100%PES

C/604 Sabbia dorata Albem

C/607 Borgogna Bourdeau





200035
VERBENA

TAGLIA UNICA TAILLE UNIQUE
SERGE
SERGE
208gr/m²
100%PES

C/001 Nero Noir
C/104 Blu Mann



200038
SAUCO

TAGLIA UNICA *TAILLE UNIQUE*

SERGE

SERGE

208gr/m²

100%PES

C/001 *Nero Noir*

200043
HAYA

TAGLIA UNICA TAILLE UNIQUE
SERGE
SERGE
208gr/m²
100%PES

C/133 Corallo Coral
C/107 Celeste Celeste
C/143 Acqua marina Eau de mer





garysworkwear.com



200045
IXOLA

TAGLIA UNICA TAILLE UNIQUE
SERGE
SERGE
208gr/m²
100%PES

C/619 Mattone Chaudière
C/596 Blu Navy
C/599 Kaki Kaki
C/597 Sabbia Sable
C/001 Nero Noir
C/598 Cenere Cendre







200046
GAZANIA

TAGLIA UNICA TAILLE UNIQUE

SERGE

SERGE

208gr/m²

100%PES

C/599 Kaki Kaki

C/619 MattoneChaudière

C/596 Blu scuro Navy

C/001 Nero Noir

C/598 Cenere Cendre

C/597 Sabbia Sable

MAGLIA FINE

POINT FIN

195 gr/m² - 95%PES 5%EA

Tessuto elastico e morbido.
Garantisce comfort e libertà di movimento.

Resistente alle macchie.

Asciugatura rapida.

Non è necessaria la stiratura.

Repelle i capelli.

Tissu très élastique et doux.

Garantit confort et liberté de mouvement.

Résistant aux taches.

Séchage très rapide.

Repassage pas nécessaire

Le cheveux ne s'adhère pas.



garysworkwear.com

850005
BREZO

XS-XXL
MAGLIA FINE
POINT FIN
195 gr/m²
95%PES 5%EA

C/001 Nero Noir



850006
LILLO

XS-XXL
MAGLIA FINE
POINT FIN
195 gr/m²
95%PES 5%EA

C/001 Nero Noir



850007
SABINA

DONNA FEMME
XS-XXL
MAGLIA FINE
POINT FIN
195 gr/m²
95%PES 5%EA

C/001 Nero Noir
C/101 Bianco Blanc

850004
CARPE

UOMO HOMME
XS-XXL
MAGLIA FINE
POINT FIN
195 gr/m²
95%PES 5%EA

C/001 Nero Noir
C/101 Bianco Blanc

Disponibile in entrambi i colori
per uomo e donna.

*Disponibile dans les couleurs pour hommes et
pour femmes.*

Repelle i
Repousse



capelli

les cheveux

850024

MELIA

DONNA WOMAN

XS-XXL

MAGLIA FINE

POINT FIN

195 gr/m²

95%PES 5%EA

C/001 Nero Noir

C/101 Bianco Bianco

850023

MALUS

UOMO MAN

XS-XXL

MAGLIA FINE

POINT FIN

195 gr/m²

95%PES 5%EA

C/001 Nero Noir

C/101 Bianco Bianco

Disponibile in entrambi i colori
per uomo e donna.

*Disponibile dans les couleurs pour hommes et
pour femmes.*





SERGE ELASTICA
SERGÉ ÉLASTIQUE

206 gr/m² - 59%CO 39%PES
2%EA

Tessuto morbido ed elasticizzato.
Con drappeggio e piacevole al
tatto.

*Tissu fluide et élastique.
Tombant et agréable au toucher.*

600054
ACIRÓN

Unisex

XS-XXL

SERGE

SERGE

206 gr/m²

59%CO 39%PES 2%EA

C/149 Verde kaki Green kaki

C/151 Cammello Couleur camel

C/001 Nero Noir





Toppe termoadesive ricamate

Rapiécer Thermocollants

Ora puoi scegliere la tua toppa ricamata per personalizzare il tuo capo e differenziare il tuo stile. Applicala a casa con un ferro da stiro.

Vous pouvez maintenant choisir votre Rapiécer pour Personnaliser votre chemise et différencier votre style. Appliquez-le avec le fer à repasser vous mêmes à la maison.



REF.390001



REF.390002



REF.390003



REF.390004

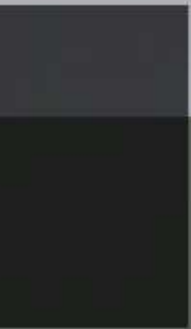

BEAUTY & RETAIL

DENIM PELLE TESSUTO

JEAN CUIR.

PRINCIPALE DENIM
TISSU PRINCIPAL JEAN
400 gr/m² 100%CO

TESUTTO SECONDARIO PELLE
RICICLATA
TISSU SECONDAIRE CUIR RECYCLÉ
448 gr/m² 100%LE

Combinazione di denim con accessori
in pelle.
Materiali durevoli, resistenti alle
macchie e alle pieghe e di facile cura.

*Combinaison de jeans et d'accessoires
en cuir. Matériaux durables, résistants
aux taches et aux plis et faciles à
entretenir.*

100004 GREMBIULE CON PETTORINA TABLIER CUIRASSE

Unisex Unisex

TAGLIA UNICA TAILLE UNIQUE
TESSUTO PRINCIPALE DENIM
TISSU PRINCIPAL JEAN
400 gr/m²
100%CO

TESSUTO SECONDARIO SECONDARY
TISSU SECONDAIRE CUIR RECYCLÉ
448 gr/m²
100%LE

C/104 Blu Marin



RETRO MODELLI
MODÈLES DE DOS
REF. 100004
REF. 950008

100003

GREMBIULE CORTO *TABLIER COURT*

Unisex *Unisex*

TAGLIA UNICA TAILLE UNIQUE

TESSUTO PRINCIPALE MAJOR

TISSU PRINCIPAL JEAN

400 gr/m²

100%CO

TESSUTO SECONDARIO SECUNDARY

TISSU SECONDAIRE CUIR RECYCLÉ

448 gr/m²

100%LE

C/104 Blu Marin



garysworkwear.com



950008
GILET KURUME VEST
Unisex *Unisex*

TAGLIA UNICA TAILLE UNIQUE

TESSUTO PRINCIPALE MAJOR

TISSU PRINCIPAL JEAN

400 gr/m²

100%CO

TESSUTO SECONDARIO SECONDARY

TISSU SECONDAIRE CUIR RECYCLÉ

448 gr/m²

100%LE

C/104 Blu Marin





C/2001 Huesos



C/2997 Art

Con le nostre
MANTELLA MAGICHE
 rendiamo ogni appuntamento dal parrucchiere
UN'AVVENTURA!

*Avec notre cape magique chaque visite
 chez le coiffeur s'est une aventure!*



C/2999 Burbujas



C/2998 Game

350002
 MANTELLA BAMBINI KIDS CAPE
 CAPE ENFANT

UNISEX / UNISEXE
 TAGLIA UNICA TAILLE UNIQUE
 TESSUTO MAROCAINE
 PLATE MARROQUINE
 122 gr/m²
 100%PES



TESSUTO MAROCAINE

MARROQUINE WOVEN

122 gr/m² - 100%PES

Tessuto marocaine molto fine.
Leggero, morbido e fresco.
Non si squalcisce.
Asciuga rapidamente.
Repelle i capelli.

*Tissuè plat très fin.
Léger, doux et frais
Ça ne se froisse pas.
Sèche très rapidement.
Repousse les cheveux.*

350300
MANTELLA CAPE

UNISEX UNISEXE

TAGLIA UNICA TAILLE UNIQUE

TESSUTO MAROCAINE

PLATE MARROQUINE

122 gr/m²

100%PES

C/001 Nero Noir



C/2003 Spine



C/2006 Mom



C/2008 Brush



C/2005 Skull



C/2007 Hairstyle

350001
 MANTELLA STAMPA CAPE IMPRIMÉE
 UNISEX UNISEXE
 TAGLIA UNICA TAILLE UNIQUE
 TESSUTO MAROCAINE
 PLATE MARROQUINE
 122 gr/m²
 100%PES



C/2004 Barber



C/2002 Inferno



596900
TUNICA CANNA TUNIQUE CANNA
TAGLIA UNICA TAILLE UNIQUE
TESSUTO MAROCAINE
PLATE MARROQUINE
122 gr/m²
100%PES

C/139 Grigio marengo Gris anthracite
C/101 Bianco Blanc
C/001 Nero Noir



116500
GREMBIULE METALLIZZATO
TABLIERMÉTALLISÉ

TAGLIA UNICA TAILLE UNIQUE
500 gr/m²
ESTERNO SURFACE 100%PU/PC
INTERNO SUPORT 67%PES 33%CO

C/001 Nero Noir

PANTALONI

Pantalons



700036

Donna *Femme*

Slim fit.

Vita media

Taille moyenne

Taglie Tailles 36-52

MICROFIBRA 360

MICROFIBRE 360

170 gr/m²

95%PES 5%EA

C/001 Nero Noir

C/101 Bianco Blanc

C/152 Blu grigiastro Gris bleu



700047

Unisex Unisex

Multitasca Multipoches

Regular fit.

Vita media

Taille moyenne

XS-XXL

MICROFIBRA 360 VIGORÉ

MICROFIBRE 360 CHINÉ

170 gr/m²

95%PES 5%EA

C/117 Grigio perla *Gris perle*





700045

Donna *Femme*

Pantaloni Capri

Pirate

Regular fit.

Vita media

Taille moyenne

XS-XXL

MICROFIBRA 360

MICROFIBRE 360

170 gr/m²

95%PES 5%EA

C/001 Nero *Noir*

C/101 Bianco *Blanc*



704700
Jogger

Unisex *Unisex*

Vita media
Taille moyenne
XSS-YL
MICROFIBRA 360
MICROFIBRE 360
170 gr/m²
95%PES 5%EA

C/001 Nero Noir
C/101 Bianco Blanc



Scopri tutti i colori di questo modello sul nostro sito.

Consultez toutes les couleurs de ce modèle sur notre site web.

garysworkwear.com

700042
Donna *Woman*
Slim fit.

Vita media
Taille moyenne
XS-XXL
PEACH
125 gr/m²
100%PES

IMPERMEABILE *HYDROFUGE*

C/001 Nero Noir





700600

Unisex

Regular fit.

Vita media

Taille moyenne

XSS-YL

MICROFIBRA MICROFIBRE

148 gr/m²

100%PES

C/139 Grigio marengo Gris anthracite

C/101 Bianco Blanc

C/142 Sabbia Sable

C/001 Nero Noir

+ Plus sizes

2YL-3YL-4YL-5YL-6YL

c/101 Bianco Blanc

c/001 Nero Noir



Scopri tutti i colori di questo modello sul nostro sito.

Consultez toutes les couleurs de ce modèle sur notre site web.

garysworkwear.com



700052

Donna *Femme*

Pantaloni cropped *À la cheville*

Slim fit.

Vita media

Taille moyenne

XS-XXL

TESSUTO WOVEN

PLATE

120 gr/m²

95%PES 5%EA

C/001 Nero Noir

C/101 Bianco Blanc



700048

Donna Woman

Culotte

Vita media

Taille moyenne

XS-XXL

MAGLIA CRÉPE SPESSA

TRICOT ÉPAIS EN CRÉPE

265 gr/m²

95%PES 5%EA

C/001 Nero Noir



700044

Donna Woman

Culotte

Vita media

Taille moyenne

XS-XXL

CRÉPE

CRÉPE

220 gr/m²

97%PES 3%EA

C/001 Nero Noir





700049
Donna *Femme*
Regular fit.

Vita media
Taille moyenne
XS-XXL
TESSUTO WOVEN
PLATE
220 gr/m²
88%PES 12%EA

C/110 Beige
C/001 Nero Noir
C/169 Blu maya *Bleu maya*



700038

Donna *Femme*

Culotte

Vita media

Taille moyenne

XS-XXL

BAMBULA

160 gr/m²

100%PES

C/110 Beige



700046

Donna *Femme*

Culotte

Vita media

Taille moyenne

XS-XXL

BAMBULA

160 gr/m²

100%PES

C/157 Nude

C/154 Verde muschio Vert mousse

C/110 Beige



700033

Donna *Femme*
Regular fit.

Vita media
Taille moyenne
XS-YL

BAMBULA
160 gr/m²
100%PES

C/110 Beige
C/154 Verde muschio *Vert mouise*



780300

Donna *Femme*
Slim fit.
Push up!

Vita media
Taille moyenne
Taglie *Tailles* 36-60
DENIM JEAN
280 gr/m²
97%CO 3%EA

C/110 Denim sabbia *Denim sable*
C/839 Denim nero *Denim noir*
C/841 Denim blu navy *Denim marin*
C/843 Denim verde *Denim green*



780200

Uomo *Man*
Slim fit.

Vita media
Taille moyenne
Taglie *Tailles* 36-60
VAQUERO JEAN
280 gr/m²
97%CO 3%EA

C/110 Denim sabbia *Denim sable*
C/839 Denim nero *Denim noir*
C/841 Denim blu navy *Denim marin*
C/843 Denim verde *Denim green*



704900
Regular fit.

Vita media
Taille moyenne
UNISEX UNISEXE
XSS-YL
X-LINEN
195 gr/m²
65%PES 30%VI 5%EA

C/157 Nude
C/110 Beige
C/001 Nero Noir
C/104 Blu Marin
Disponibile anche in: *disponible en c/155 Verde acqua vert aqua*



700051
Pirata
Regular fit.

Vita media
Taille moyenne
DONNA FEMME
XS-XXL
X-LINEN
195 gr/m²
65%PES 30%VI 5%EA

C/157 Nude
C/110 Beige
C/001 Nero Noir
C/104 Blu Marin



ADAPTATION SYSTEM

Vita espandibile nascosta con regolazione elastica, che consente fino a una misura di vita in più.

Ceinture extensible cachée avec réglage par élastique, permettant jusqu'à une taille de plus à la taille.

700024

Regular fit.

Vita media *Taille moyenne*

Elastico interno

Élastique intérieur

DONNA FEMME

Taglie *Tailles* 36-58

STRECH

165 gr/m²

100%PES

C/001 Nero Noir

C/104 Blu Marin



700016

Regular fit.

Vita media *Taille moyenne*

Elastico interno

Élastique intérieur

UOMO HOMME

Taglie *Tailles* 36-60

STRECH

165 gr/m²

100%PES

C/001 Nero Noir

C/104 Blu Marin





Liquid-repellent



Breathable



Machine washable



360° Fit



Humidity control



Elasticity

700021

Regular fit.

Vita media *Taille moyenne*
DONNA FEMME
Taglie *Tailles* 36-58
INTERLOCK
INTERLOCK POINTE
200 gr/m²
92%PES 82%EA



C/001 Nero *Noir*

700018

Regular fit.

Vita media *Taille moyenne*
UOMO HOMME
Taglie *Tailles* 36-60
INTERLOCK
INTERLOCK POINTE
200 gr/m²
92%PES 82%EA



C/001 Nero *Noir*



202300
Slim fit.

Donna *Femme*

Vita media *Taille moyenne*

Senza pince *Sans pinces*

Taglie *Tailles* 36-56

SERGE

SERGÉ

215 gr/m²

96%PES 4%EA

C/001 Nero Noir

C/104 Blu Marin



203600
Strech

Donna *Femme*

Vita media *Taille moyenne*

Senza pince *Sans pinces*

Taglie *Tailles* 36-56

STRECH

165 gr/m²

100%PES

C/001 Nero Noir

C/104 Blu Marin



203900
Regular fit.

Donna *Woman*

Vita media *Taille moyenne*

XSS-XXL

TESSUTO WOVEN

PLATE

120 gr/m²

86%PES 14%EA

C/001 Nero Noir



203500
Regular fit.

Donna *Femme*

Vita media *Taille moyenne*

Senza pince *Sans pinces*

Taglie *Tailles* 36-56

SERGE

SERGÉ

215 gr/m²

96%PES 4%EA

C/001 Nero Noir



HIDRÓFUGO

Stain-resistant

REF. 312200
Spray idrorepellente
Water repellent spray

PROTETTORE TESSILE
PROTECTEUR TESSILE

PROTEGGE LA TUA UNIFORME

- *Applica lo spray uniformemente sulla superficie del tessuto che vuoi proteggere.*
- *Fai asciugare il prodotto completamente, possono volerci fino a 8 ore.*
- *Una volta asciutto, come risultato si avrà uno strato protettivo che repelle i liquidi, mantenendo i capo e i tessuti protetti da fuoriuscite e macchie di liquidi.*

PROTÉGEZ VOTRE UNIFORME

- *Appliquez uniformément le spray sur la surface textile que vous souhaitez protéger.*
- *Laissez le produit sécher complètement, ce qui peut prendre jusqu'à 8 heures.*
- *Une fois sec, le résultat sera une couche protectrice qui repousse les liquides, maintenant vos vêtements et tissus protégés contre les déversements et les taches liquides.*



Antimicrobial



Liquid-repellent



Reusable



Stain-resistant



Machine washable



Invisible



Breathable



Anti-odour

PREVIENE LA CRESCITA MICROBICA | FACILITA LA PULIZIA
ALLUNGA LA DURATA UTILE DEL TESSUTO | DERMATOLOGICAMENTE TESTATO

PRÉVIENT LA CROISSANCE MICROBIENNE | FACILITE LE NETTOYAGE
PROLONGE LA DURÉE DE VIE DU TISSU | TESTÉ DERMATOLOGIQUEMENT



PRO
TEXGO
PROTECTOR TESSILE

orkwear.com

MISURE

TABLEAU DES MESURES

Aiutano le taglie appropriate ad ogni persona.

CESES MESURES SONT PRISES SUR LA PERSONNE POUR LUI ATTRIBUER LA TAILLE APROPRIÉE.



CM. MISURA BASE DONNA MESURES DE BASSE HOMME

TAGLIE	TAILLES	P			M			G			SG						
		XSS	XS		S		M		L		XL		XXL		YL		
		34	36	38	40	42	44	46	48	50	52	54	56	58	60	62	64
PETTO	POITRINE	78-81	82-85	86-89	90-93	94-97	98-101	102-105	106-109	110-113	114-117	118-121	122-125	126-129	130-133	134-137	128-141
VITA	TAILLE	60	64	68	72	76	80	84	88	92	96	100	104	108	112	116	120
ANCA	HANCHE	84	88	92	96	100	104	108	112	116	120	124	128	132	136	140	144



CM. MISURE BASE UOMO E UNISEX MESURES DE BASSE HOMME

TAGLIE	TAILLES	P			M			G			SG					
		XSS	XS		S		M		L		XL		XXL		YL	
		40	42	44	46	48	50	52	54	56	58	60	62	64	66	68
PETTO	POITRINE	78-81	82-85	86-89	90-93	94-97	98-101	102-105	106-109	110-113	114-117	118-121	122-125	126-129	130-133	134-137
VITA	TAILLE	66	70	74	78	82	86	90	94	98	102	106	110	114	118	122
ANCA	HANCHE	78	82	86	90	94	98	102	106	110	114	118	122	126	130	134

CM. MISURE BASE PER PANTALONI RAGAZZO E UNISEX MESURES DE BASE POUR PANTALON HOMME ET UNISEXE





TAGLIE	TAILLES	XSS	XS		S		M		L		XL		XXL		YL	
		34	36	38	40	42	44	46	48	50	52	54	56	58	60	62
VITA	TAILLE	68	72	76	80	84	88	92	96	100	104	108	112	116	120	124

BOZZETTI E CARATTERISTICHE DEI CAPI

CROQUIS ET CARACTÉRISTIQUES DES VÊTEMENTS

<p>100003 P.94</p>  <ul style="list-style-type: none"> - Sistema di chiusura con fibbia e moschettone - Sistema di regolazione della fibbia - 3 tasche centrale - Lunghezza circa: 30cm. <p>Systeme de fermeture à boucle avec mouqueton - Système de réglage avec boucle - 3 poches avant - Longueur approximative: 30cm</p>	<p>100004 P.92</p>  <ul style="list-style-type: none"> - Sistema di chiusura con fibbia e moschettone - Sistema di regolazione della fibbia - 6 tasche anteriori - Lunghezza circa: 73cm <p>Systeme de fermeture à boucle avec mouqueton - Système de réglage à celette et à cliquet - 6 poches avant - Longueur approximative: 73cm</p>	<p>116500 P.101</p>  <ul style="list-style-type: none"> - Fibbia per regolare la tracolla - Senza tasche - Laccio 100% PES - Lunghezza circa: 85cm <p>Boucle pour ajuster la sangle de cou - Sans poches - Sangle 100% PES - Longueur approximative: 85cm</p>	<p>200029 P.72</p>  <ul style="list-style-type: none"> - Lacci laterali per regolare - 2 tasche laterali - Pince sul retro - Lunghezza circa: 63x69cm <p>Bandes latérales pour ajustement - 2 poches latérales - Pince dans le dos - Longueur approximative: 63x69cm</p>
---	--	---	--

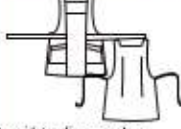
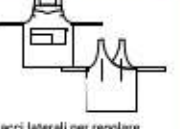
<p>200031 P.74</p>  <ul style="list-style-type: none"> - Lacci laterali per regolare - 2 tasche laterali - Pince sul giromanica e retro - Lunghezza circa: 71x81cm <p>Bandes latérales pour ajustement - 2 poches latérales - Pince aux emmanchures et au dos - Longueur approximative: 71x81cm</p>	<p>200032 P.69</p>  <ul style="list-style-type: none"> - Lacci laterali per regolare - Tasca centrale - Pince sul giromanica e retro - Lunghezza circa: 71x81cm <p>Bandes latérales pour ajustement - Poches centrale - Pince aux emmanchures et au dos - Longueur approximative: 71x81cm</p>	<p>200034 P.67</p>  <ul style="list-style-type: none"> - Lacci laterali per regolare - 4 tasche laterali - Cimosa sul giromanica e sul retro - Lunghezza circa: 50x80cm <p>Bandes latérales pour ajustement - 4 poches latérales - Coutures aux emmanchures et au dos - Longueur approximative: 55x80cm</p>	<p>200035 P.76</p>  <ul style="list-style-type: none"> - Lacci laterali per regolare - 1 tasca laterale con cerniera - Pince sul retro - Lunghezza circa: 71x81cm <p>Bandes latérales pour ajuster - 1 poche latérale à fermeture éclair - Pince dans le dos - Longueur approximative: 71x81cm</p>	<p>200036 P.68</p>  <ul style="list-style-type: none"> - Lacci laterali per regolare - 2 tasche laterali - Pince sul giromanica e retro - Lunghezza circa: 64x70cm <p>Bandes latérales pour ajuster - 2 poches latérales - Pince aux emmanchures et au dos - Longueur approximative: 64x70cm</p>	<p>200037 P.70</p>  <ul style="list-style-type: none"> - Lacci laterali per regolare - Tasca laterale - Pince sul giromanica e retro - Lunghezza circa: 71x78cm <p>Bandes latérales pour ajuster - Poches latérale - Pince aux emmanchures et au dos - Longueur approximative: 71x78cm</p>	<p>200038 P.77</p>  <ul style="list-style-type: none"> - Lacci laterali per regolare - 2 tasche laterali - Pince sul giromanica e retro - Lunghezza circa: 71x78cm <p>Bandes latérales pour ajuster - 2 poches latérales - Pince aux emmanchures et au dos - Longueur approximative: 71x78cm</p>	<p>200039 P.71</p>  <ul style="list-style-type: none"> - Lacci laterali per regolare - 2 tasche laterali - Cimosa sul davanti e sul retro - Lunghezza circa: 71x78cm <p>Bandes latérales pour ajuster - 2 poches latérales - Coutures sur le devant et dans le dos - Longueur approximative: 71x80cm</p>
---	---	---	---	--	--	--	--

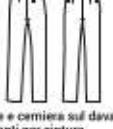
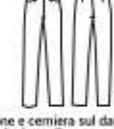
<p>200043 P.78</p>  <ul style="list-style-type: none"> - Lacci laterali per regolare - 2 tasche laterali - Cimosa sul davanti - Lunghezza circa: 63x72cm <p>Bandes latérales pour ajuster - 2 poches latérales - Coutures sur le devant - Longueur approximative: 63x72cm</p>	<p>200044 P.75</p>  <ul style="list-style-type: none"> - Lacci laterali per regolare - 3 tasche laterali - Cimosa sul davanti - Pince sul retro - Lunghezza circa: 62x73cm <p>Bandes latérales pour ajuster - 3 poches latérales - Coutures sur le devant - Pince dans le dos - Longueur approximative: 62x73cm</p>	<p>200045 P.80</p>  <ul style="list-style-type: none"> - Lacci laterali per regolare - 2 tasche centrale - Pince sul giromanica e retro - Lunghezza circa: 74x70cm <p>Bandes latérales pour ajuster - 2 poches latérales - Pince aux emmanchures et au dos - Longueur approximative: 74x70cm</p>	<p>200046 P.83</p>  <ul style="list-style-type: none"> - Lacci laterali per regolare - 2 tasche laterali - Pince sul retro - Lunghezza circa: 63x72cm <p>Bandes latérales pour ajuster - 2 poches latérales - Pince dans le dos - Longueur approximative: 63x72cm</p>	<p>200047 P.73</p>  <ul style="list-style-type: none"> - Lacci laterali per regolare - 2 tasche laterali - Pince sul giromanica e retro - Lunghezza circa: 62x83cm <p>Bandes latérales pour ajuster - 2 poches latérales - Pince aux emmanchures et au dos - Longueur approximative: 62x83cm</p>	<p>200048 P.73</p>  <ul style="list-style-type: none"> - Lacci laterali per regolare - 5 passanti per cintura - Pince sul giromanica e retro - Lunghezza circa: 70x79cm <p>Bandes latérales pour ajuster - 5 passants à la taille - Pince aux emmanchures et au dos - Longueur approximative: 70x79cm</p>	<p>202300 P.115</p>  <ul style="list-style-type: none"> - Bottone e cerniera sul davanti - 5 passanti per cintura - Tessuto elastico - Lunghezza circa: 106cm - D1: ADERENTE <p>Bouton et fermeture éclair à l'avant - 5 passants à la taille - Tissue élastique - Longueur approximative: 106cm - F1: AJUSTÉE</p>	<p>203500 P.115</p>  <ul style="list-style-type: none"> - Bottone e cerniera sul davanti - 2 tasche laterali - 5 passanti per cintura - Lunghezza circa: 106cm - D1: ADERENTE <p>Bouton et fermeture éclair à l'avant - 2 poches latérales - 5 passants à la taille - Longueur approximative: 106cm - F1: AJUSTÉE</p>
---	--	--	--	--	---	---	--

<p>203600 P.115</p>  <ul style="list-style-type: none"> - Bottone e cerniera sul davanti - 5 passanti per cintura in vita - Lunghezza circa: 107cm - D1: ADERENTE <p>Bouton et fermeture éclair à l'avant - 5 passants à la taille - Longueur approximative: 107cm - F1: AJUSTÉE</p>	<p>203900 P.115</p>  <ul style="list-style-type: none"> - Elastico intorno alla vita - Tessuto elastico - Lunghezza circa: 107cm - D2: SEMIADERENTE <p>Gomme à la taille complète. - Tissue élastique. - Longueur approximative: 107cm - F2: SEMI AJUSTÉE</p>	<p>350001 P.99</p>  <ul style="list-style-type: none"> - Fibbia per regolare il colletto - Laccetti sul colletto - Asola per appendere - Lunghezza circa: 148cm <p>Boucle pour ajuster le col - Paire de col - Ruban pour suspendre - Longueur approximative: 148cm</p>	<p>350002 P.97</p>  <ul style="list-style-type: none"> - Fibbia per regolare il colletto - Laccetti sul colletto - Asola per appendere - Lunghezza circa: 117cm <p>Boucle pour ajuster le col - Paire de col - Ruban pour suspendre - Longueur approximative: 117cm</p>	<p>350300 P.98</p>  <ul style="list-style-type: none"> - Fibbia per regolare il colletto - Laccetti sul colletto - Asola per appendere - Lunghezza circa: 148cm <p>Boucle pour ajuster le col - Paire de col - Ruban pour suspendre - Longueur approximative: 148cm</p>	<p>550005 P.54</p>  <ul style="list-style-type: none"> - Chiusura a camicia e bottoni - Pince sul giromanica e retro - Cintura per regolare - Lunghezza circa: 100cm - D2: SEMIADERENTE <p>Fermeture par bretelles et boutons. - Pince aux emmanchures et au dos - Ceinture pour ajuster - Longueur approximative: 100cm - F2: SEMI AJUSTÉE</p>	<p>552800 P.65</p>  <ul style="list-style-type: none"> - Cerniera centrale - 2 tasche laterali - Pince sul giromanica e retro - Lunghezza circa: 73cm - D3: MORBIDO <p>Fermeture éclair centrale - 2 poches latérales - Pince aux emmanchures et au dos - Longueur approximative: 73cm - F2: SEMI AJUSTÉE</p>	<p>596900 P.100</p>  <ul style="list-style-type: none"> - Cintura per regolare - Senza abbottonatura - Lunghezza circa: 93cm - D3: MORBIDO <p>Ceinture pour ajuster - Sans boutonnage - Longueur approximative: 93cm - F3: AMPLÉ</p>
--	---	---	--	---	--	--	--

<p>600021 P.39</p> <ul style="list-style-type: none"> -Asola fissa per regolare -Manica a pipistrello -Lunghezza circa: 67 cm -D2 SEMIADERENTE -Nœud fixe pour ajuster -Manche japonaise -Longueur approximative: 67cm -F2 SEMI AJUSTÉE 	<p>600022 P.23</p> <ul style="list-style-type: none"> -Manica dropped -Pinces sul retro -Lunghezza circa: 65 cm -D3 MORBIDO -Manche tombante -Pinces dans le dos -Longueur approximative: 65cm -F2 AMPLE 	<p>600023 P.24</p> <ul style="list-style-type: none"> -Bottoni a pressione nascosti -2 tasche laterali -Cintura per regolare -Manica giapponese -Lunghezza circa: 69cm -D3 MORBIDO -Boutons pression cachés -2 poches latérales -Devants pour ajuster -Manche japonaise -Longueur approximative: 69cm -F3 AMPLE 	<p>600024 P.42</p> <ul style="list-style-type: none"> -Bottoni a pressione sullo scollo -Spacco sui fianchi -Tasca laterale -2 pince sul retro -Lunghezza circa: 65cm -D2 SEMIADERENTE -Bouton pression au décolleté -Ouverture sur les côtés -Poche latérale -2 pince dans le dos -Longueur approximative: 65 cm -F2 SEMI AJUSTÉE 	<p>600025 P.33</p> <ul style="list-style-type: none"> -Manica dropped -2 tasche laterali -Pinces sul gronamica e retro -Lunghezza circa: 67cm -D2 SEMIADERENTE -Manche tombante -2 poches latérales -Pinces aux emmanchures et au dos -Longueur approximative: 67cm -F2 SEMI AJUSTÉE 	<p>600026 P.34</p> <ul style="list-style-type: none"> -Manica dropped con spacco -Apertura frontale -Tessuto a maglia -Lunghezza circa: 65cm -D2 SEMIADERENTE -Manche tombante avec ouverture -Ouverture à l'avant -Tissu en tricot -Longueur approximative: 65cm -F2 SEMI AJUSTÉE 	<p>600027 P.56</p> <ul style="list-style-type: none"> -Bottoni a pressione nascosti -Spacco sui fianchi -2 tasche laterali -Cintura per regolare -Lunghezza circa: 69cm -D2 SEMIADERENTE -Bouton pression caché -Ouverture sur les côtés -2 poches latérales -Cinture pour ajuster -Longueur approximative: 69 cm -F2 SEMI AJUSTÉE 	<p>600028 P.58</p> <ul style="list-style-type: none"> -Manica dropped con spacco -Lacci per regolare in vita -Tessuto idrorepellente -Lunghezza circa: 72cm -D2 SEMIADERENTE -Manche tombante avec ouverture -Bandes pour ajuster à la taille -Tissu hydrofuge -Longueur approximative: 72 cm -F2 SEMI AJUSTÉE
--	---	--	---	---	---	---	---





























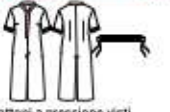

<p>600029 P.61</p> <ul style="list-style-type: none"> -Sistema di chiusura ad anello -Bottoni nascosti sullo scollo -Tasca laterale destra -Lunghezza circa: 73 cm -D2 SEMIADERENTE -Système de fermeture par nœud -Bouton caché au décolleté -Poche latérale droite -Longueur approximative: 73 cm -F2 SEMI AJUSTÉE 	<p>600031 P.26</p> <ul style="list-style-type: none"> -Bottoni a pressione nascosti -Bottoni nascosti sullo scollo -2 tasche laterali -Piega sul retro -Lunghezza circa: 73 cm -D2 SEMIADERENTE -Boutons pression cachés -Bouton caché au décolleté -2 poches latérales -Scufflet amers -Longueur approximative: 73 cm -F2 SEMI AJUSTÉE 	<p>600032 P.10</p> <ul style="list-style-type: none"> -2 tasche laterali -2 spacchi sui fianchi -Pince posteriori -Lunghezza circa: 67 cm -D2 SEMIADERENTE -2 poches latérales -2 ouvertures frontales sur les côtés -Pince dans le dos -Longueur approximative: 67 cm -F2 SEMI AJUSTÉE 	<p>600033 P.6</p> <ul style="list-style-type: none"> -Bottoni a pressione nascosti e visibili -Tasca laterale destra -Lacci per regolare sul fianco -Lunghezza circa: 69 cm -D2 SEMIADERENTE -Boutons pression cachés et visibles -Poche latérale droite -Rubans de réglage sur le côté -Longueur approximative: 69 cm -F2 SEMI AJUSTÉE 	<p>600035 P.33</p> <ul style="list-style-type: none"> -Bottoni a pressione nascosti -2 tasche laterali -Collo mao -Lunghezza circa: 75 cm -U3 MORBIDO -Boutons pression cachés -2 poches latérales -Col Mao -Longueur approximative: 75 cm -F3 AMPLE 	<p>600036 P.40</p> <ul style="list-style-type: none"> -Manica dropped -Pince sul retro -Lunghezza circa: 60 cm -D2 SEMIADERENTE -Manche tombante -Pince dans le dos -Longueur approximative: 60 cm -F2 SEMI AJUSTÉE 	<p>600037 P.48</p> <ul style="list-style-type: none"> -2 bottoni a pressione sul davanti -2 tasche laterali -Lacci per regolare -Lunghezza circa: 70 cm -D2 SEMIADERENTE -2 boutons pression sur le devant -2 poches latérales -Ceinture pour ajuster -Longueur approximative: 70 cm -F2 SEMI AJUSTÉE 	<p>600039 P.47</p> <ul style="list-style-type: none"> -Colletto tuxedo -2 tasche laterali -Cintura per regolare -Lunghezza circa: 71 cm -D2 SEMIADERENTE -Col smoking -2 poches latérales -Ceinture pour ajuster -Longueur approximative: 71 cm -F2 SEMI AJUSTÉE
---	--	--	--	---	--	--	---

<p>600041 P.63</p> <ul style="list-style-type: none"> -Bottoni a pressione -Manica semilunga -Bottoni automatici sulle maniche -Lunghezza circa: 75 cm -D2 SEMIADERENTE -Boutons pression visibles -Manche demi-longue -Bouton pression automat sur les manches -Longueur approximative: 75 cm -F2 SEMI AJUSTÉE 	<p>600042 P.62</p> <ul style="list-style-type: none"> -Cintura per regolare -Tasca laterale -Manica con spacco -Pince sul retro -Lunghezza circa: 71 cm -D2 SEMIADERENTE -Ceinture pour ajuster -Poche latérale -Manche avec ouverture -Pince dans le dos -Longueur approximative: 71 cm -F2 SEMI AJUSTÉE 	<p>600054 P.88</p> <ul style="list-style-type: none"> -Bottoni camicia -4 spacchi sui fianchi -Manica con spacco -Pince sul retro -Lunghezza circa: 78 cm -U3 MORBIDO -Boutons de style chemise -4 poches sur le devant -Epaulettes aux épaules -Pince dans le dos -Longueur approximative: 78 cm -U3 AMPLE 	<p>600055 P.8</p> <ul style="list-style-type: none"> -Cintura per regolare -Tasca laterale -Pince sul retro -Lunghezza circa: 78 cm -D2 SEMIADERENTE -Ceinture pour ajuster -Poche latérale -Pince dans le dos -Longueur approximative: 78 cm -F2 SEMI AJUSTÉE 	<p>600056 P.30</p> <ul style="list-style-type: none"> -Bottoni a pressione nascosti -2 tasche laterali -Spacco sulle maniche -Pince sul retro -Lunghezza circa: 71 cm -D2 SEMIADERENTE -Boutons pression cachés -2 poches latérales -Ouverture aux manches -Pince dans le dos -Longueur approximative: 71 cm -F2 SEMI AJUSTÉE 	<p>600057 P.9</p> <ul style="list-style-type: none"> -Cerniera centrale -2 tasche laterali -Pince sul retro -Lunghezza circa: 72 cm -D2 SEMIADERENTE -Fermeture éclair centrale -2 poches latérales -Pince dans le dos -Longueur approximative: 72 cm -F2 SEMI AJUSTÉE
--	--	--	---	--	---

U1 ADERENTE | UOMO
U2 SEMIADERENTE | UOMO
U3 MORBIDO | UOMO
 M1 AJUSTÉES | HOMME
 M2 SEMI AJUSTÉES | HOMME
 M3 AMPLE | HOMME

<p>600058 P.15</p> <ul style="list-style-type: none"> -Cerniera centrale -2 tasche laterali -Cimosa sul davanti -Pince sul retro -Lunghezza circa: 76 cm -D2 SEMIADERENTE -Fermeture éclair centrale -2 poches latérales -Pince sur le devant -Pince dans le dos -Longueur approximative: 76 cm -F2 SEMI AJUSTÉE 	<p>600059 P.56</p> <ul style="list-style-type: none"> -Bottoni a pressione nascosti -2 tasche laterali -Cimosa sul davanti e retro -Lunghezza circa: 74 cm -D2 SEMIADERENTE -Boutons pression cachés -2 poches latérales -Pince sur le devant et dans le dos -Longueur approximative: 74 cm -F2 SEMI AJUSTÉE 	<p>600061 P.28</p> <ul style="list-style-type: none"> -Bottoni a pressione nascosti -Tasca sul petto -Collo mao -Finta asola sul retro -Lunghezza circa: 74 cm -U2 SEMIADERENTE -Boutons pression cachés -Tasche -Col Mao -Scufflet dans le dos -Longueur approximative: 74 cm -U2 SEMI AJUSTÉE 	<p>610600 P.12</p> <ul style="list-style-type: none"> -Bottoni a pressione nascosti -2 bottoni visibili -Tasca laterale sinistra -Pince sul retro -Lunghezza circa: 73 cm -U2 SEMIADERENTE -Boutons pression cachés -2 boutons visibles -Poche latérale gauche -Scufflet dans le dos -Longueur approximative: 73 cm -U2 SEMI AJUSTÉE 	<p>610900 P.20</p> <ul style="list-style-type: none"> -Cerniera centrale -2 tasche laterali -Spacco sui fianchi -Pince sul retro -Lunghezza circa: 73 cm -U2 SEMIADERENTE -Fermeture éclair centrale -2 poches latérales -Ouverture sur les côtés -Pince dans le dos -Longueur approximative: 73 cm -U2 SEMI AJUSTÉE 	<p>634700 P.64</p> <ul style="list-style-type: none"> -Bottoni a pressione nascosti -2 tasche laterali -Pince sul gronamica e retro -Lunghezza circa: 73 cm -D2 SEMIADERENTE -Boutons pression cachés -2 poches latérales -Pince aux emmanchures et au dos -Longueur approximative: 73 cm -F2 SEMI AJUSTÉE
---	---	--	---	---	---

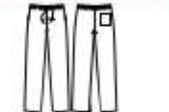
D1 ADERENTE | DONNA
D2 SEMIADERENTE | DONNA
D3 MORBIDO | DONNA
 W1 AJUSTÉES | FEMME
 W2 SEMI AJUSTÉES | FEMME
 W3 AMPLE | FEMME

<p>634800 P.16</p>  <ul style="list-style-type: none"> -Cerniera centrale -2 tasche laterali -Pincini sul giromanica e retro -Lunghezza circa: 73cm -D2 SEMIADERENTE -Fermature éclair centrale -2 poches latérales -Pincés aux emmanchures et au dos -Longueur approximative: 73 cm -F2: SEMI AJUSTÉE 	<p>635500 P.14</p>  <ul style="list-style-type: none"> -Bottoni a pressione nascosti -4 tasche laterali -Cimosa sul davanti e retro -Lunghezza circa: 75cm -D2 SEMIADERENTE -Boutons pression dissimulés -4 poches latérales -Pié sur le devant et dans le dos -Longueur approximative: 75 cm -F2: SEMI AJUSTÉE 	<p>635800 P.5</p>  <ul style="list-style-type: none"> -Bottoni a pressione nascosti -2 tasche laterali -Cimosa sul davanti -Lunghezza circa: 75cm -D2 SEMIADERENTE -Boutons pression dissimulés -2 poches latérales -Pié sur le devant -Longueur approximative: 75 cm -F2: SEMI AJUSTÉE 	<p>651600 P.52</p>  <ul style="list-style-type: none"> -Bottoni a pressione nascosti -2 tasche laterali -Pincini sul giromanica e retro -Spacchi laterali -Lunghezza circa: 83cm -D2 SEMIADERENTE -Concealer press studs -2 poches latérales -Pincés aux emmanchures et au dos -Fentes latérales -Longueur approximative: 83 cm -F2: SEMI AJUSTÉE 	<p>652200 P.11</p>  <ul style="list-style-type: none"> -Cerniera centrale -Tasca laterale destra -Cimosa sul davanti -Pincini sul retro -Lunghezza circa: 71cm -D2 SEMIADERENTE -Fermature éclair centrale -Fermature éclair droite -Pié sur le devant -Pincés au dos -Longueur approximative: 71 cm -F2: SEMI AJUSTÉE 	<p>652500 P.19</p>  <ul style="list-style-type: none"> -Cerniera centrale -2 tasche laterali -Cimosa sul davanti e retro -Lunghezza circa: 75cm -D2 SEMIADERENTE -Fermature éclair centrale -2 poches latérales -Pié sur le devant et au dos -Longueur approximative: 75 cm -F2: SEMI AJUSTÉE 	<p>652600 P.53</p>  <ul style="list-style-type: none"> -2 tasche laterali -Cintura per regolare -Spacchi sui fianchi -Lunghezza circa: 69cm -D2 SEMIADERENTE -2 poches latérales -Ceinture pour ajuster -Fentes latérales -Longueur approximative: 69cm -F2: SEMI AJUSTÉE 	<p>652800 P.7</p>  <ul style="list-style-type: none"> -Bottoni a pressione nascosti -2 tasche laterali -Cimosa sul davanti e retro -Lunghezza circa: 77cm -D2 SEMIADERENTE -Boutons pression dissimulés -2 poches latérales -Pié sur le devant et au dos -Longueur approximative: 77cm -F2: SEMI AJUSTÉE
<p>652900 P.20</p>  <ul style="list-style-type: none"> -Cerniera centrale -2 tasche sul davanti -Cimosa sul davanti -Pincini sul retro -Lunghezza circa: 79cm -D2 SEMIADERENTE -Fermature éclair centrale -2 poches latérales -Pié sur le devant -Pincés au dos -Longueur approximative: 79cm -F2: SEMI AJUSTÉE 	<p>653200 P.12</p>  <ul style="list-style-type: none"> -Bottoni a pressione nascosti -2 bottoni visibili -Tasca laterale destra -Pincini sul retro -Lunghezza circa: 72cm -D2 SEMIADERENTE -Boutons pression dissimulés -2 boutons visibles -Poche latérale droite -Soufflets dans le dos -Longueur approximative: 72cm -F2: SEMI AJUSTÉE 	<p>653500 P.4</p>  <ul style="list-style-type: none"> -Bottono ornamento -Pincini sul giromanica e retro -Lunghezza circa: 69cm -D2 SEMIADERENTE -Bouton visible en ornement -Pincés aux emmanchures et au dos -Longueur approximative: 69cm -F2: SEMI AJUSTÉE 	<p>700016 P.113</p>  <ul style="list-style-type: none"> -Vita regolabile -Bottono e cerniera sul davanti -2 tasche laterali -Tasca posteriore -6 passanti per cintura -Tessuto elasticizzato -Lunghezza circa: 106cm -D2 SEMIADERENTE -Bouton et fermeture éclair sur le devant -2 poches latérales -Poche arrière -6 passants à la taille -Tissu élastique -Longueur approximative: 106cm -F2: SEMI AJUSTÉE 	<p>700018 P.114</p>  <ul style="list-style-type: none"> -Bottono e cerniera sul davanti -2 tasche laterali -Tasca posteriore -6 passanti per cintura -Tessuto elasticizzato -Lunghezza circa: 106cm -D2 SEMIADERENTE -Bouton et fermeture éclair sur le devant -2 poches latérales -Poche arrière -6 passants à la taille -Tissu élastique -Longueur approximative: 106cm -F2: SEMI AJUSTÉE 	<p>700021 P.114</p>  <ul style="list-style-type: none"> -Bottono e cerniera sul davanti -2 tasche laterali -Tasca posteriore -6 passanti per cintura -Tessuto elasticizzato -Lunghezza circa: 106cm -D2 SEMIADERENTE -Bouton et fermeture éclair sur le devant -2 poches latérales -Poche arrière -6 passants à la taille -Tissu élastique -Longueur approximative: 106cm -F2: SEMI AJUSTÉE 	<p>700024 P.113</p>  <ul style="list-style-type: none"> -Vita regolabile -Bottono e cerniera sul davanti -2 tasche laterali -Tasca posteriore -5 passanti per cintura -Lunghezza circa: 106cm -D2 SEMIADERENTE -Bouton et fermeture éclair sur le devant -2 poches latérales -Poche arrière -5 passants à la taille -Tissu élastique -Longueur approximative: 106cm -F2: SEMI AJUSTÉE 	<p>700033 P.111</p>  <ul style="list-style-type: none"> -Elastico sul retro -2 tasche laterali -Pincini sul davanti -Lunghezza circa: 94cm -D2 SEMIADERENTE -Élastique à l'arrière -2 poches latérales -Pincés à l'avant -Longueur approximative: 94cm -F2: SEMI AJUSTÉE
<p>700036 P.102</p>  <ul style="list-style-type: none"> -Bottono e cerniera sul davanti -Elastico sui lati -2 tasche laterali -Spacco frontale -Lunghezza circa: 95cm D1 ADERENTE -Bouton et fermeture éclair sur le devant -Élastique sur les côtés -2 poches latérales -Ouverture sur le devant -Longueur approximative: 95cm F1 AJUSTÉE 	<p>700037 P.38</p>  <ul style="list-style-type: none"> -Chiusura sul retro con bottone -2 tasche laterali -Cintura per regolare -Lunghezza circa: 142cm -D1 ADERENTE -Fermeture à bouton sur le dos -2 poches latérales -Ceinture pour ajuster -Longueur approximative: 142cm -F1 AJUSTÉE 	<p>700038 P.110</p>  <ul style="list-style-type: none"> -Pantaloni culotte -Elastico sul retro -Pincini sul davanti -2 strati di tessuto -Lunghezza circa: 101cm -D2 SEMIADERENTE -Pantalons culotte -Élastique à l'arrière -Pincés à l'avant -2 couches de tissu -Longueur approximative: 101cm -F2: SEMI AJUSTÉE 	<p>700039 P.44</p>  <ul style="list-style-type: none"> -2 bottoni a pressione visti -2 tasche laterali -Cintura per regolare -Pincini sul giromanica e retro -Lunghezza circa: 134cm -D1 ADERENTE -2 boutons pression visibles -2 poches latérales -Ceinture pour ajuster -Pincés aux emmanchures et au dos -Longueur approximative: 134cm -F2: SEMI AJUSTÉE 	<p>700041 P.35</p>  <ul style="list-style-type: none"> -2 tasche laterali -Cintura per regolare -Tessuto in maglia -Lunghezza circa: 135cm -D2 SEMIADERENTE -2 poches latérales -Ceinture pour ajuster -Tissu en tricot -Longueur approximative: 135cm -F2: SEMI AJUSTÉE 	<p>700042 P.105</p>  <ul style="list-style-type: none"> -Elastico sul retro -3 tasche laterali -Cintura per regolare -Tessuto impermeabile -D2 SEMIADERENTE -Élastique à l'arrière -3 poches latérales -Ceinture pour ajuster -Tissu hydrofuge -F2: SEMI AJUSTÉE 	<p>700044 P.108</p>  <ul style="list-style-type: none"> -Pantaloni culotte -Elastico intorno alla vita -Tasca laterale destra -Lunghezza circa: 92cm -D2 SEMIADERENTE -Pantalons culotte -Élastique sur toute la ceinture -Poche latérale droite -Longueur approximative: 92cm -F2: SEMI AJUSTÉE 	<p>700045 P.104</p>  <ul style="list-style-type: none"> -Elastico sul retro e fianchi -2 tasche laterali -Pincini sul davanti -Lunghezza circa: 96cm -D1 ADERENTE -Élastique à l'arrière et sur les côtés -2 poches latérales -Pincés à l'avant -Longueur approximative: 96cm -F1 AJUSTÉE
<p>700046 P.110</p>  <ul style="list-style-type: none"> -Pantaloni culotte -Elastico sul retro -Pincini sul davanti -2 tasche laterali -Lunghezza circa: 90cm -D2 SEMIADERENTE -Pantalons culotte -Élastique à l'arrière -Pincés à l'avant -2 poches latérales -Longueur approximative: 90cm -F2: SEMI AJUSTÉE 	<p>700047 P.103</p>  <ul style="list-style-type: none"> -Elastico sul retro -3 tasche laterali -Lunghezza circa: 107cm -D2 SEMIADERENTE -Élastique à l'arrière -3 poches latérales -Longueur approximative: 107cm -F2: SEMI AJUSTÉE 	<p>700048 P.108</p>  <ul style="list-style-type: none"> -Pantaloni culotte -Tessuto in maglia -Lunghezza circa: 87cm -D2 SEMIADERENTE -Pantalons culotte -Tissu en tricot -Longueur approximative: 87cm -F2: SEMI AJUSTÉE 	<p>700049 P.109</p>  <ul style="list-style-type: none"> -Elastico sul retro -2 tasche laterali -Pincini sul davanti -Lunghezza circa: 94cm -D1 ADERENTE -Élastique à l'arrière -2 poches latérales -Pincés à l'avant -Longueur approximative: 94cm -F1 AJUSTÉE 	<p>700051 P.112</p>  <ul style="list-style-type: none"> -Elastico sul retro e lati -2 tasche laterali -Bottoni decorativi sulla gamba -Pantaloni alla caviglia -Lunghezza circa: 94cm -D1 ADERENTE -Élastique sur les côtés -2 poches latérales -Boutons décoratifs sur le bas -Pantalons chevilles -Longueur approximative: 94cm -F1 AJUSTÉE 	<p>700052 P.107</p>  <ul style="list-style-type: none"> -Elastico sui lati -2 tasche laterali -Spacco sulla gamba -Lunghezza circa: 91cm -D1 ADERENTE -Élastique sur les côtés -2 poches latérales -Fentes sur le bas -Longueur approximative: 91cm -F1 AJUSTÉE 	<p>700050 P.106</p>  <ul style="list-style-type: none"> -Cordino elastico con terminale -2 tasche laterali e tipo toppa posteriore -Lunghezza circa: 110cm -D2 SEMIADERENTE -Cordon élastique avec embout -2 poches latérales et une poche arrière type patch -Longueur approximative: 110cm -F2: SEMI AJUSTÉE 	<p>700050 P.105</p>  <ul style="list-style-type: none"> -Elastico sul retro e lati -2 tasche laterali e tipo toppa posteriore -Orlo del polsino caviglia -Lunghezza circa: 103cm D1 ADERENTE -Élastique à l'arrière et sur les côtés -2 poches latérales et une poche arrière type patch -Pochets en bas -Longueur approximative: 103cm -F1 AJUSTÉE

704900 P.112	780200 P.111	780300 P.111
<ul style="list-style-type: none"> -Cordino elastico con terminale -2 tasche laterali e 2 tasche sul retro -Lunghezza circa: 110cm -U2 SEMIADERENTE -Cordon elastique avec embout -2 poches latérales et 2 à l'arrière de style patch -Longueur approximative: 110cm -H2 SEMI AJUSTÉE 	<ul style="list-style-type: none"> -Bottono e cerniera sul davanti -3 tasche laterali e 2 tasche tipo topa sul retro -5 passanti per cintura -Tessuto elasticizzato -Lunghezza circa: 110cm -U1 ADERENTE -Bouton et fermeture éclair à l'avant -3 poches latérales et 2 à l'arrière de style patch -5 passants à la taille -Tissu élastique -Longueur approximative: 110cm -H1 AJUSTÉE 	<ul style="list-style-type: none"> -Bottono e cerniera sul davanti -3 tasche laterali e 2 tasche tipo topa sul retro -5 passanti per cintura -Tessuto elasticizzato -Lunghezza circa: 110cm -U1 ADERENTE -Bouton et fermeture éclair à l'avant -3 poches latérales et 2 poches type patch à l'arrière -5 passants à la taille -Tissu élastique -Longueur approximative: 110cm -H1 AJUSTÉE

800041 P.59	850004 P.86	850005 P.85
<ul style="list-style-type: none"> -Cerniera centrale -2 tasche laterali -Colletto, polsini e orlo a costine -Maniche raglan -Lunghezza circa: 62cm -U2 SEMIADERENTE -Fermeture éclair centrale -2 poches latérales -Bord-côte au col, aux poignets et à l'ourlet -Manche raglan -Longueur approximative: 62cm -H2 SEMI AJUSTÉE 	<ul style="list-style-type: none"> -T-shirt in maglia -Manica corta -Lunghezza circa: 71cm -U2 SEMIADERENTE -T-shirt en tricot -Manches courtes -Longueur approximative: 71cm -H2 SEMI AJUSTÉE 	<ul style="list-style-type: none"> -T-shirt in maglia -Manica corta -Lunghezza circa: 71cm -U2 SEMIADERENTE -T-shirt en tricot -Manches courtes -Longueur approximative: 71cm -H2 SEMI AJUSTÉE

850006 P.85	850007 P.86	850012 P.36
<ul style="list-style-type: none"> -T-shirt in maglia -Manica corta -Lunghezza circa: 71cm -U2 SEMIADERENTE -T-shirt en tricot -Manches courtes -Longueur approximative: 71cm -H2 SEMI AJUSTÉE 	<ul style="list-style-type: none"> -T-shirt in maglia -Manica corta -Lunghezza circa: 61cm -U1 ADERENTE -T-shirt en tricot -Manches courtes -Longueur approximative: 61cm -H1 AJUSTÉE 	<ul style="list-style-type: none"> -T-shirt in maglia -Spacco sui fianchi -Manica lunga -Lunghezza circa: 68cm -U1 ADERENTE -T-shirt en tricot -Ouverture sur les côtés -Manches longues -Longueur approximative: 68cm -H1 AJUSTÉE

850023 P.87	850024 P.87	950008 P.95	950011 P.50
<ul style="list-style-type: none"> -T-shirt in maglia -Manica lunga -Lunghezza circa: 74cm -U2 SEMIADERENTE -T-shirt en tricot -Manches longues -Longueur approximative: 74cm -H2 SEMI AJUSTÉE 	<ul style="list-style-type: none"> -T-shirt in maglia -Manica lunga -Lunghezza circa: 62cm -U1 ADERENTE -T-shirt en tricot -Manches longues -Longueur approximative: 62cm -H1 AJUSTÉE 	<ul style="list-style-type: none"> -Sistema di chiusura regolabile con moschettoni -Sistema di regolazione con occhiali e bottono -2 tasche frontali -Lunghezza circa: 58cm -Système de fermeture réglable avec mouquetons -Système de réglage avec occhils et bouton -2 poches à l'avant -Longueur approximative: 58cm 	<ul style="list-style-type: none"> -2 bottoni a pasticca sul lato anteriore -2 tasche laterali -Fibbie laterali per regolare -Lunghezza circa: 71cm -U2 SEMIADERENTE -2 boutons de pastille à l'avant -2 poches latérales -Boucles latérales pour ajuster -Longueur approximative: 71cm -H2 SEMI AJUSTÉE



LA NOSTRA AZIENDA

Il continuo impegno per l'innovazione e la qualità (sia nel servizio che nei materiali) ha mantenuto l'azienda in costante sviluppo alla ricerca dell'eccellenza. È così che otteniamo materie prime di alto livello nelle mani di uno straordinario team dedito all'azienda.

Nel 2019, dopo essersi affermata come leader del settore sul mercato nazionale e anni di rapporti commerciali di successo all'estero, l'azienda ha iniziato la sua espansione su larga scala.

La nostra missione è la progettazione e produzione di abbigliamento professionale, offrendo un ottimo servizio e un ampio catalogo di prodotti per i lavoratori più esigenti.

Gary's è leader nel mercato dell'abbigliamento da lavoro grazie ai suoi design eleganti, sia a livello nazionale che internazionale. Forniamo design unici noti per il loro comfort, protezione e durata a tutti i lavoratori che utilizzano i nostri capi d'abbigliamento.

L'azienda guarda al futuro preservando i valori della propria identità.

L'ECCELLENZA SUL LAVORO COSTITUISCE L'ESSENZA DELLE UNIFORMI GARY, ATTRAVERSO I VALORI CHE LA GUIDANO: INTEGRITÀ, QUALITÀ, INNOVAZIONE, VICINANZA E PASSIONE.

Siamo una scommessa sicura per tutti i professionisti che desiderano vestirsi in modo comodo, moderno e sicuro durante il loro lavoro quotidiano.

THE COMPANY

Notre engagement constant en faveur de l'amélioration et de la qualité –(de nos services comme des matériaux que nous choisissons), a conduit notre entreprise à se développer de façon continue dans le but d'atteindre l'excellence. Notre extraordinaire équipe, engagée ainsi à nos côtés, donne vie à des matières premières de haute qualité.

En 2019, après être devenus les leaders de notre secteur au niveau national, et après avoir développé des relations commerciales au-delà des frontières espagnoles, nous avons amorcé l'internationalisation de notre entreprise à grande échelle.

Nous nous donnons pour mission de créer et confectionner des uniformes tout en proposant un excellent service et un large catalogue de produits pour les professionnels les plus exigeants.

Gary's est la référence en matière de mode professionnelle, sur la scène nationale autant que sur la scène internationale. Le design, le confort, la protection et la durabilité : voilà tout ce qui distingue les professionnels qui font le choix de porter nos créations.

Aujourd'hui, notre entreprise se concentre sur l'avenir en n'oubliant jamais les valeurs qui fondent son identité.

L'ECCELLENCE PROFESSIONNELLE CONSTITUE L'ESSENCE MÊME DES UNIFORMES GARY'S. UN ENGAGEMENT PORTÉ PAR DES VALEURS : L'INTEGRITÉ, LA QUALITÉ, L'INNOVATION, LA PROXIMITÉ ET LA PASSION.

Nous sommes une valeur sûre pour tous les professionnels qui souhaitent porter des uniformes confortables et modernes sur leur lieu de travail.

Hai un'idea?

Got any idea?

Creiamo qualsiasi modello tu immagini. Stampe personalizzate, modelli personalizzati, personalizzazione di componenti, ricami o serigrafie. La fantasia non ha limiti e insieme possiamo trasformare la tua idea in realtà.

Vous songez à personnaliser votre tenue avec une broderie ? Nous brodons tous types d'uniformes professionnels. Grâce à du matériel dernière génération et à notre équipe d'experts, vous pourrez faire broder votre logo ou une phrase. Le tout, avec qualité.



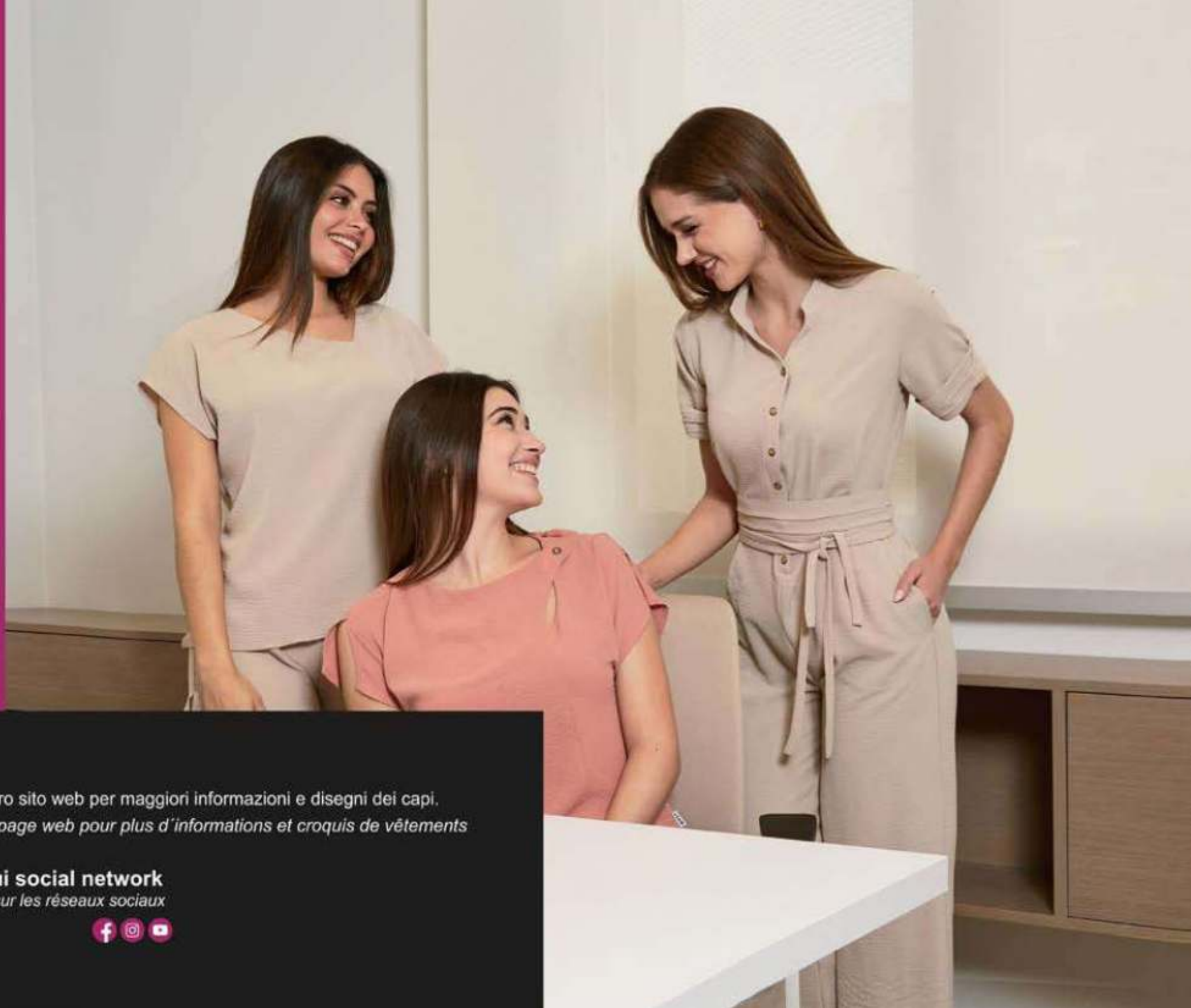

Consulta il nostro sito web per maggiori informazioni e disegni dei capi.
Consulte notre page web pour plus d'informations et croquis de vêtements

Seguici sui social network

Suivez-nous sur les réseaux sociaux



BEAUTY & RETAIL



8429935530598

©Uniformes Gary's

La riproduzione totale o parziale di questo catalogo, così come il suo trattamento in qualsiasi forma e con qualsiasi mezzo, è vietata senza l'empresa autorizzazione scritta della società titolare del copyright.

Toute reproduction totale ou partielle de ce catalogue, comme sa modification sous quelque forme ou par quelques moyens que ce soit est strictement interdite sans autorisation préalable et écrite de l'entreprise titulaire des droits d'auteur.



gary's WORKWEAR

HORECA

NOVITÀ

Les dernières nouveautés de HORECA



HORECA

NOVITÀ

Les dernières nouveautés de HORECA

Aggiungiamo alla nostra linea ospitalità una collezione unica e rischiosa che permette uno stile più personale, abbinando capi che vestono e compongono la tua divisa, capi pratici e versatili intramontabili e di alta qualità uniti in un campionario che nuovamente espone il nostro costante cambiamento e l'evoluzione, perché la relazione tra moda e divisa è fondamentale e la tua divisa è un modo in più di espressione professionale.

Nous ajoutons à notre ligne hôtelière une collection unique et risquée qui permet un style plus personnel, combinant des vêtements qui s'adaptent et façonnent ton uniforme vêtements pratiques et polyvalents intemporels et de haute qualité dans notre catalogue qui expose nouvellement nos changements évolutifs constants car la relation entre la mode et les uniformes est essentielle et une voie d'expression professionnelle.

INDICE

REF.	PAGE	REF.	PAGE
210002	4	700022	24
210003	10	700023	24
210005	13	700024	34
210006	17	700027	33
210007	17	700028	33
210008	4	700029	26
210009	15	700031	26
210011	15	700032	25
210012	18	700033	25
210013	10	700043	27
210014	13	750400	28
260001	18	780200	31
550005	21	780300	31
700016	34	780400	30
700017	29	780500	30
700018	36	850001	22
700019	38	850002	22
700021	36		



garysworkwear.com

Le camicie hawaiane con tagli semplici i motivi floreali e il colore
sona una moda in movimento.

*Avec ses coupes simples ses motifs floraux et les chemises
hawaïennes une mode en mouvement.*

REF. 210002

CAMICIA UOMO HAWAII
CHEMISE HOMME HAWAII
TAGLIE/TAILLES 38-50
PIATTO/TISSAGE PLAT 80 gr/m²
100%VI

REF. 210008

CAMICE DONNA HAWAIANA
CHEMISE FEMME HAWAÏENNE
TAGLIE/TAILLES XS-YL
PIATTO/TISSAGE PLAT 80 gr/m²
100%VI

C/1126 TUCÁN

REF. 778800 BERMUDA UOMO/BERMUDA HOMME (P. 43 CAT. DENIM)
REF. 205600 BERMUDA DONNA/BERMUDA FEMME (P. 43 CAT. DENIM)



C/1128 HIBISCUS

Crea una tendenza
Etablie une tendance



C/1127 PARAÍSO

**TRASMETTERE
UNA BUONA IMMAGINE**
e la chiave

Transmettre une bonne image c'est la clef

REF. 700032 PANTALONE UOMO/PANTALON HOMME(P. 25)
REF. 700033 PANTALONE DONNA/PANTALON FEMME (P. 25)



C/1132 COCONUT

REF. 778800 BERMUDA UOMO/BERMUDA HOMME (P. 43 CAT. DENIM)
REF. 205600 BERMUDA DONNA/BERMUDA FEMME (P. 43 CAT. DENIM)



C/1129 ROYAL

REF. 700032 PANTALONE DOMMA/PANTALON FEMME (P. 25)
REF. 700033 PANTALONE UOMO/PANTALON HOMME (P. 25)



C/1133 PALMA

REF. 700029 BERMUDA UOMO/BERMUDA HOMME (P. 26)
REF. 700031 BERMUDA DONNA/BERMUDA FEMME (P. 26)

REF. SK200051 EC UOMO/HOMME (P. 9 CAT. SKECHERS)
REF. SK77210 EC DONNA/FEMME (P. 25 CAT. SKECHERS)

La Guayabera è la camicia formale in molti paesi latinoamericani.
Un capo classico contemporaneo per climi tropicali ed estivi.

*La Guayabera est une chemise officielle dans beaucoup de pays d'Amérique Latine et Amérique Centrale.
Un vêtement classique contemporaine pour climats tropicaux et estivaux.*

REF. 210003

GUAYABERA UOMO BORNEO
GUAYABERA BORNEO HOMME
TAGLIE/TAILLES 38-50
PIATTO/TESSAGE PLAT 120 gr/m²
55%LI 45%CO

C/110 BEIGE
C/101 BIANCO/BLANC

REF. 210013

GUAYABERA DONNA ISABELA
GUAYABERA ISABELA FEMME
TAGLIE/TAILLES XS-YL
PIATTO/TESSAGE PLAT 120 gr/m²
55%LI 45%CO

C/110 BEIGE
C/101 BIANCO/BLANC



REF. 700027 PANTALONE CHINO UOMO/PANTALON CHINO HOMME (P. 33)
REF. 700028 PANTALONE CHINO DONNA/PANTALON CHINO FEMME (P. 33)



REF. SK200051EC UOMMO/HOMME (P. 9 CAT. SKECHERS)
REF. SK77210EC DONNA/FEMME (P. 25 CAT. SKECHERS)



REF. 210005

GUAYABERA UOMO SALOMÓN
GUAYABERA HOMME SALOMON
TAGLIE/TAILLES 38-50
PIATTO/TESSAGE PLAT 120 gr/m²
55%LI 45%CO

C/110 BEIGE
C/101 BIANCO/BLANC

REF. 210014

GUAYABERA DONNA SUMATRA
GUAYABERA FEMME SUMATRA
TAGLIE/TAILLES XS-YL
PIATTO/TESSAGE PLAT 120 gr/m²
55%LI 45%CO

C/110 BEIGE
C/101 BIANCO/BLANC

Creando imagine
Création d'image



REF. 700022 BERMUDA UOMO/BERMUDA HOMME (P. 24)
REF. 700023 BERMUDA DONNA/BERMUDA FEMME (P. 24)

REF. SK200051EC UOMO/HOMME (P. 9 CAT. SKECHERS)
REF. SK77210EC DONNA/FEMME (P. 25 CAT. SKECHERS)



La quintessenza
**DI DESIGN
E COMFORT**

Une déclaration de conception et de confort

REF. 210011
CAMICIA DONNA LANAY
CHEMISE FEMME LANAY
TAGLIE/TAILLES XS-YL
CHAMBRAY 146 gr/m²
80%CO 20%PES

C/110 BEIGE
C/101 BIANCO/BLANC

REF. 210009
CAMICIA UOMO NIAS
CHEMISE HOMME NIAS
TAGLIE/TAILLES 38-50
CHAMBRAY 146 gr/m²
80%CO 20%PES

C/110 BEIGE
C/101 BIANCO/BLANC

REF. 700027 PANTALONE CHINO UOMO/PANTALON CHINO HOMME (P. 33)
REF. 700028 PANTALONE CHINO DONNA/PANTALON CHINO FEMME (P. 33)

REF. SK77210EC DONNA/FEMME (P. 25 CAT. SKECHERS)



C/104 NAVY/BLEU MARINE



C/154 VERDE MUSGO
VERT MOUSSE



C/101 BIANCO/BLANC

C/110 BEIGE

REF. 210007
CAMICIA UOMO TIWI
CHEMISE HOMME TIWI
TAGLIE/TAILLES 38-50
PIATTO/TISSAGE PLAT
122 gr/m²
55%LI 45%CO

REF. 210006
CAMICIA DONNA KAULA
CHEMISE FEMME KAULA
TAGLIE/TAILLES XS-YL
PIATTO/TISSAGE PLAT
122 gr/m²
55%LI 45%CO

Disponibili in tutti i colori per uomo e donna
Disponible de toutes les couleurs pour homme et femme

REF. 700029 BERMUDA UOMO/BERMUDA HOMME (P. 26)
REF. 700031 BERMUDA DONNA/BERMUDA FEMME (P. 26)

REF. SK200051 EC UOMO/HOMME (P. 9 CAT. SKECHERS)
REF. SK77210 EC DONNA/FEMME (P. 25 CAT. SKECHERS)



Tessuto a maglia elastico e flessibile con una struttura a maglia di trama molto compatta, soffice e opaca, con aspetto identico su entrambi i lati. Ha qualità idrorepellenti, quindi previene l'umidità che lo rende molto traspirante.

Tissu élastique et souple, structure en maille très compacte effect duvet et opaque, aspect identique sur les deux faces. Possède des qualités hydrofuges afin d'éviter l'humidité et les fuites, et lui permet d'être respirant.



Liquid-repellent



Breathable



Machine washable



360° Fit



Humidity control



Elasticity

REF. 260001

CAMICIA UOMO LUZÓN
CHEMISE HOMME LUZÓN
TAGLIE/TAILLES 38-50

MAGLIA INTERLOCK/TRICOT INTERIEUR

140 gr/m²

100%PES

C/001 NERO/NOIR
C/101 BIANCO/BLANC

REF. 210012

CAMICIA DONNA CERDEÑA
CHEMISE FEMME CERDEÑA
TAGLIE/TAILLES XS-YL

MAGLIA INTERLOCK/TRICOT INTERIEUR

140 gr/m²

100%PES

C/001 NERO/NOIR
C/101 BIANCO/BLANC

REF. 700027 PANTALONE CHINO UOMO/PANTALON CHINO HOMME (P. 33)
REF. 700028 PANTALONE CHINO DONNA/PANTALON CHINO FEMME (P. 33)



REF. 700027 PANTALONE CHINO UOMO/PANTALON CHINO HOMME (P. 33)
REF. 700028 PANTALONE CHINO DONNA/PANTALON CHINO FEMME (P. 33)

Ispira con il tuo stile

Inspire avec ton style

garysworkwear.com



Vestito/Robe

REF. 550005

TAGLIE/TAILLES XS-YL

POLIESTERE VISCOSA/POLYESTER VISCOSE

210 gr/m²

89%PES-7%VI-4%EA

C/T110 BEIGE

REF. SK77210EC (P. 25 CAT. SKECHERS)

Polos

Uomo/Homme

REF. 850001

TAGLIE/TAILLES XS-6YL

MAGLIA INTERLOCK/TRICOT

INTERIEUR 150 gr/m²

100%PES

Donna/Femme

REF. 850002

TAGLIE/TAILLES XS-2YL

MAGLIA INTERLOCK/TRICOT

INTERIEUR 150 gr/m²

100%PES

TUV
SÜD



ANTI ODOUR



MOISTURE WICKING



TRANSPIRABLE



QUICK DRY

Disponibili in tutti i colori per uomo e donna

Disponible de toutes les couleurs pour homme et femme

Più confortevole, più semplice
PIÙ UNIFORME

Plus confortable, plus simple, plus uniforme

C/107 AZURRO/ BLEU CIEL



C/101 BIANCO/BLANC

REF.750400 BERMUDA MULTI-TASCHE UNISEX
BERMUDA MULTI-POCHES UNISEX (P. 28)



C/110 BEIGE

REF.778800 BERMUDA UOMO/BERMUDA HOMME (P. 43 CAT DENIM)
REF. SK77071 EC UOMO/HOMME (P. 8 CAT. SKECHERS)



C/001 NERO/NOIR



C/109 GRIGIO/GRIS



C/104 NAVY/BLEU MARINE

PANTALONI PANTALONS



REF. SK200051 EC UOMO/HOMME (P. 9 CAT. SKECHERS)
REF. SK77210EC DONNA/FEMME (P. 25 CAT. SKECHERS)

REF. 700023
BERMUDA DONNA FIOCCO
BERMUDA FEMME LAZO
TAGLIE/TAILLES 36-60
PIATTO/TISSAGE PLAT
210gr/m²
89%PES 7%VI 4%EA
C/110 BEIGE



REF. 700022
BERMUDA UOMO
BERMUDA HOMME
TAGLIE/TAILLES 36-60
PIATTO/TISSAGE PLAT
210gr/m²
89%PES 7%VI 4%EA
C/110 BEIGE





REF. 700033
PANTALONE DONNA/PANTALON FEMME
TAGLIE/TAILLES XS-YL
BAMBULA/DE BAMBOU 160 gr/m²
100%PES



C/110 BEIGE **C/154 VERDE MUSGO**
VERT MOUSSE

REF. 700032
PANTALONE UOMO/PANTALON HOMME
TAGLIE/TAILLES XS-YL
BAMBULA/DE BAMBOU 160 gr/m²
100%PES



C/110 BEIGE **C/154 VERDE MUSGO**
VERT MOUSSE



HIDRÓFUGO
STAIN-RESISTANT

Il tessuto idrorepellente è stato sottoposto a un trattamento che protegge il capo dall'umidità e dalle perdite, impedendo all'acqua di essere assorbita e formare uno strato sulla superficie rendendolo altamente traspirante.

Un tissu hydrofuges soumis à un traitement qui permet d'éviter l'humidité et les fuites, qui empêche l'absorption de l'humidité et les fuites, qui empêche l'absorption de l'eau et forme une couche en superficie qui lui permet d'être respirant.



C/104 NAVY
BLEU MARIN

C/108 VERDE
VERT

C/142 SABBIA/SABLE

REF. 700029

BERMUDA UOMO/BERMUDA HOMME
TAGLIE/TAILLES 36-60
PIATTO/TESSAGE PLAT 158gr/m²
100%PES



C/104 NAVY
BLEU MARINE

C/108 VERDE
VERT

C/142 SABBIA/SABLE

REF. 700031

BERMUDA DONNA/BERMUDA FEMME
TAGLIE/TAILLES XS-YL
PIATTO/TESSAGE PLAT 158gr/m²
100%PES

REF. SK200051 EC UOMO/HOMME (P. 9 CAT. SKECHERS)
REF. SK77210 EC DONNA/FEMME (P. 25 CAT. SKECHERS)





Pantagonna *Jupe culotte*

REF. 700043
DONNA/FEMME
TAGLIE/TAILLES 36-60
MICROFIBRA/MICROFIBRE 148gr/m²
100%PES



C/101 BIANCO
BLANC

C/104 NAVY
BLEU MARINE

C/001 NERO
NOIR

Bermuda multi-tasche

Bermuda multi-poches

REF. 750400

UNISEX

TAGLIE/TAILLES 36-56

TWILL/SERGE 200gr/m²

65%PES 33%CO 2%EA



C/101 BIANCO
BLANC

C/104 MARINE
BLEU MARINE

C/110 BEIGE

C/149 VERDE KAKI
VERT KAKI



C/109 GRIGIO
GRIS

C/159 NAVY

C/001 NERO
NOIR



REF. SK200054EC UOMO/HOMME (P. 29 CAT. SKECHERS)
REF. SK108021EC DONNA/FEMME (P. 21 CAT. SKECHERS)



Bermuda microfibra *Bermuda microfibre*

REF. 700017
BERMUDA
TAGLIE/TAILLES XS-YL
UNISEX
MICROFIBRA/MICROFIBRE 148gr/m²
100%PES



C/104 MARINE
BLEU MARINE

C/101 BIANCO
BI ANC

C/001 NERO
NOIR

DENIM SUPER STRETCH

garys

Questo tessuto denim ha un'innovativa miscela di fibre che lo rende estremamente elastico, consentendo maggiore agilità e flessibilità adattandosi e mantenendo la sua la sua forma, anche con un uso frequente.

Ce tissu denim se compose d'un innovant mélange de fibres qui lui permet une meilleure agilité et souplesse en s'ajustant et maintenant les formes incluant son usage fréquent

REF. 780400
BERMUDA HUOMO DENIM CASDY
BERMUDA HOMME DENIM CASDY
TAGLIE/TAILLES 36-60
DENIM 280gr/m²
97%PES 3%EA



C/841 CASDYMARINE
CASDY BLEU MARINE

REF. 780500
BERMUDA DONNA DENIM CASDY
BERMUDA FEMME DENIM CASDY
TAGLIE/TAILLES 34-58
DENIM 280gr/m²
97%PES 3%EA



C/841 CASDYMARINE
CASDY BLEU MARINE





DENIM SUPER
gary's STRETCH

REF. SK200051EC UOMO/HOMME (P. 9 CAT. SKECHERS)
REF. SK77210EC DONNA/FEMME (P. 25 CAT. SKECHERS)



REF. 780200
DENIM UOMO CASDY/DENIM HOMME CASDY
TAGLIE/TAILLES 36-60
DENIM 280gr/m²
97%CO 3%EA

C/839 NERO DENIM
NOIR DENIM

C/843 VERDE DENIM
VERT DENIM



C/842 SABBIA DENIM
SABLE DENIM

C/841 MARINE DENIM
BLEU MARINE DENIM

REF. 780300
DENIM DONNA CASDY/DENIM FEMME CASDY
TAGLIE/TAILLES 34-58
DENIM 280gr/m²
97%CO 3%EA

C/839 NERO DENIM
NOIR DENIM

C/843 VERDE DENIM
VERT DENIM



C/842 SABBIA DENIM
SABLE DENIM

C/841 MARINE DENIM
BLEU MARINE DENIM

TECNC400

by **garys** WORKWEAR

La fibra T400 offre vestibilità elastica e recupero elastico fornendo forza, elasticità, comfort, resistenza alle rughe e facilità di manutenzione. Tessuto con finitura antibatterica e idrorepellente che previene l'umidità rendendolo molto traspirante.

La fibre T400 offre un ajustement permanent son élasticité permanent son élasticité apporte une résistance et un confort, résistant aux froissements et entretien facile.

La finition impermeable évite l'humidité et les fuites le laissant respirant tout en étant antibactérien.



REF. SK200051EC UOMO/HOMME (P. 9 CAT. SKECHERS)
REF. SK77210EC DONNA/FEMME (P. 25 CAT. SKECHERS)





REF. SK77188EC UOMO/HOMME (P. 23 CAT. SKECHERS)
REF. SK77210EC DONNA/FEMME (P. 25 CAT. SKECHERS)

REF. 700027
PANTALONE CHINO UOMO/PANTALON CHINO HOMME
TAGLIE/TAILLES 36-60
TWILL/SERGE 177gr/m²
100%PES



C/001 NERO NOIR C/104 NAVY BLEU MARINE C/110 BEIGE C/151 CAMELLO CAMEL

REF. 700028
PANTALONE CHINO DONNA/PANTALON CHINO FEMME
TAGLIE/TAILLES 36-58
TWILL/SERGE 177gr/m²
100%PES



C/001 NERO NOIR C/104 NAVY BLEU MARINE C/110 BEIGE C/151 CAMELLO CAMEL

ADAPTATION SYSTEM

Vita espandibile nascosta con regolazione elastica, che permette una taglia in più.

Ceinture extensible dissimulée avec bouton-pression qui lui permet une taille supplémentaire.

REF. 700016

PANTALONE UOMO/PANTALON HOMME
ELASTICO INTERNO/ÉLASTIQUE INTÉRIEUR
TAGLIE/TAILLES 36-60
PIATTO/WOVEN 165gr/m²
100%PES

C/001 NEGRO/BLACK
C/104 MARINO/NAVY BLUE

REF. 700024

PANTALONE DONNA/PANTALON FEMME
ELASTICO INTERNO/ÉLASTIQUE INTÉRIEUR
TAGLIE/TAILLES 36-58
PIATTO/WOVEN 165gr/m²
100%PES

C/001 NERO/NOIR
C/104 NAVY/BLEU MARINE

Disponibili in tutti colori per uomo e donna

Disponible de toutes les couleurs pour homme et femme





C/001 NERO
NOIR



C/104 NAVY
BLEU MARINE

REF. SK200051 EC UOMO/HOMME (P. 9 CAT. SKECHERS)
REF. SK77236 EC DONNA/FEMME (P. 17 CAT. SKECHERS)





 CROSS
ELASTIK

REF.700021
PANTALONE DONNA/PANTALON FEMME
TAGLIE/TAILLES 36-58
MAGLIA INTERLOCK/TRICOT INTERIEUR
200 gr/m²
92%PES 8%EA

C/001 NERO/NOIR



 CROSS
ELASTIK

REF. 700018
PANTALON UOMO/PANTALON HOMME
TAGLIE/TAILLES 36-60
MAGLIA INTERLOCK/TRICOT INTERIEUR
200 gr/m²
92%PES 8%EA

C/001 NERO/NOIR



REF. SK200054EC UOMO/HOMME (P. 29 CAT. SKECHERS)
REF. SK108021EC DONNA/FEMME (P. 21 CAT. SKECHERS)

 CROSS
ELASTIK



Liquid repellent



Breathable



Machine washable



360° Fit



Humidity control



Elasticity

Pantalone STRETCH

Pantalon STRETCH

REF. 700019

TASCA FRANCESE/POCHES FRANÇAISES

DONNA/FEMME

TAGLIE/TAILLES 36-56

PIATTO STRETCH/TISSAGE PLAT STRETCH

165gr/m²

100%PES



C/001 NERO
NOIR

C/104 NAVY
BLUE MARINIF

C/139 GRIGIO
MARENGO
GRIS ANTHRACITE



REF. SK77210EC (P. 25 CAT. SKECHERS)

Hai un'idea? *Vous avez un projet?*

Creiamo qualsiasi disegno che immagini. Stampe personalizzate, modelli personalizzati, personalizzazione de passamaneria, ricamo o serigrafia. La fantasia non ha limiti e insieme possiamo realizzare la tua idea.

Nous donnons vie à toutes vos envies. Imprimés personnalisés, étalons de mesure, personnalisation d'accessoires, broderies ou sérigraphies. L'imagination manque de limite et, ensemble, nous pouvons faire de vos idées une réalité.



Consulta il nostro sito web per maggiori informazioni e disegni dei capi.
Consultez notre site WEB pour plus d'informations et croquis de nos vêtements

Seguici sui social

Suivez-nous sur les réseaux sociaux



gary's WORKWEAR

©Uniformes Gary's

La riproduzione totale o parziale di questo catalogo, così come il suo trattamento in qualsiasi forma e con qualsiasi mezzo, è vietata senza l'espresa autorizzazione scritta della società titolare del copyright.

Toute reproduction totale ou partielle de ce catalogue, comme sa modification sous quelque forme ou par quelques moyens que ce soit est strictement interdite sans autorisation préalable et écrite de l'entreprise titulaire des droits d'auteur.



UNIÓN EUROPEA
Parlaments of European Countries



8429935492179



GASTROCHEF

by **gary's**

garysworkwear.com

Happier Workplaces

Presentiamo la nuova collezione Gastrochef, il marchio Deluxe della nostra collezione di ristorazione e cucine. Una selezione esclusiva con design unici che curano anche i piccoli dettagli per quegli chef vogliono fare la differenza vestendosi in modo personale e unico al lavoro.

I professionisti del settore culinario trascorrono la maggior parte del loro tempo in una cucina dedicandosi alla loro professione, che richiede una divisa comoda e funzionale, dove i migliori materiali garantiscono comfort e durata.

I tessuti assumo un valore molto importante e optare per quelli naturali è la nostra chiave.

Questa nuova proposta reggiunge il perfetto equilibrio recuperando i codici più classici della maison, reinventati con un tocco più avanguardista a seconda dell'occasione e senza apparire massimalista.

Qualità assicurata in una perfetta fusione di tendenza e ristorazione.

Nous vous présentons la nouvelle collection signée Gastrochef, la marque Deluxe de notre gamme hôtellerie et cuisine.

Une sélection exclusive aux designs uniques où le moindre détail a été pensé pour les chefs qui souhaitent faire la différence en arborant un style personnel et unique en cuisine.

Les professionnels de la gastronomie passent le plus clair de leur temps en cuisine, à se dévouer entièrement à leur art. Ils ont donc besoin d'un uniforme confortable et fonctionnel, fabriqué à partir des meilleurs matériaux afin de garantir confort et durabilité.

Les tissus revêtent une grande importance, et il est essentiel pour nous de sélectionner des matières naturelles. Ce nouveau projet, qui reprend les codes classiques de la maison – réimaginés avec une touche plus avant-gardiste – remplit toutes ses fonctions sans être maximaliste.

L'alliage parfait entre tendance et hôtellerie. Qualité assurée.

REF.	PAGE
312200	53
930001	6
930002	29
930003	10
930004	34
930005	25
930006	39
930007	32
930008	42
930011	12
930012	50
930013	31
930014	35
930015	47
930016	8
930017	30
930018	41
930019	37
930021	49
930022	36
930023	5
930024	48
930026	43
930028	45
932000	27
932200	28
933000	14
933100	16
933400	26
933600	20
933800	18
934500	17
935500	23



STELLA MICHELÍN
ETOILE MICHELIN



STELLA MICHELÍN VERDE
ETOILE VERTE MICHELIN



REPSOL SUN
SOL REPSOL





*Il tuo stile
parla di te*

Votre style en dit long sur vous

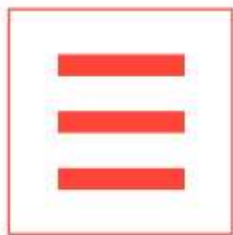

HIDRÓFUGO

Stain-resistant

Il tessuto idrorepellente è stato sottoposto a un trattamento che protegge il capo dall'umidità e dalle perdite, impedendo così all'acqua di essere assorbita, e formando uno strato sulla superficie che lo rende altamente traspirante.

Inoltre è antibatterico, biocida e agisce come barriera contro virus e batteri, prevenendo i cattivi odori.

Nous soumettons le tissu hydrofuge à un traitement permettant de rendre le vêtement imperméable. Ni humidité ni infiltration : ce processus empêche l'absorption de l'eau et protège la surface du tissu, ce qui le rend très respirant.

Il est également antibactérien, biocide et agit comme une barrière contre les virus et bactéries, empêchant ainsi l'apparition de mauvaises odeurs.



Martin BERASATEGUI

Chef spagnolo con più stelle Michelin
Chef espagnol le plus étoilé Michelin
Restaurante Martín Berasategui Lasarte - Oria
SAN SEBASTIÁN (SPAIN)



REF. 930023 HORUS
Giacca Unisex
Veste unisex
Taglia/Tailles XSS-6YL
Twill/SERGÉ 200gr/m²
63%CO 35%CLY 2%EA

c/101 Bianco/Blanc

COOLMAX



TENCEL
FIBRE SOFT

Miguel
COBO

Restaurante Cobo Estratos
BURGOS (SPAIN)



REF. 930001 OSIRIS
Giacca Unisex
Veste unisex
Taglia/Tailles: XSS-YL
TWILL/SERGÉ 200gr/m²
63%CO 35%CLY 2%EA

c/001 Nero/Noir
c/101 Bianco/Blanc

COOLMAX
Coolmax



HIDRÓFUGO
Stain-resistant

TENCEL
Fibre by nature

c/001 Nero/Noir



Cristóbal
MUÑOZ

Restaurante Ambivium
VALLADOLID (SPAIN)



c/101 Bianco/Blanc

Juan
CARMONA

Premio "Miglior Chef dell'Andalusia 2021"
Élu meilleur cuisinier andalou de l'année 2021
Cadena hotelera Helios
GRANADA (SPAIN)

REF. 930016 APIS

Giacca Unisex

Veste unisex

Taglia/Tailles XS-YL

TWILL/SERGE 200 gr/m²

63%CO 35%CLY 2%EA

c/101 Bianco/Blanc

c/001 Nero/Noir

COOLMAX
Coolmax®



HIDRÓFUGO

Water resistant



c/101 Bianco/Blanc





c/001 Nero/Noir



Fernando
MARTÍN

Restaurante Eximio
MADRID (SPAIN)

REF. 930003 THOT

Polo unisex

Polo unisex

Taglia/Tailles: XSS-6YL

INTERLOCK 200 gr/m²

92%PES 8%EA

c/101 Bianco/Blanc



HIDRÓFUGO
Stain-resistant

Tencel
Fibra de Celulosa



ECCELLENZA, INNOVAZIONE *e creatività*

Excellence, innovation et créativité



garysworkwear.com

David
CANCA

Presidente dell'Associazione Gastronomica Andalus
Président de l'Académie de gastronomie andalouse
MÁLAGA (SPAIN)

REF. 930011 AGNI

Giacca unisex/Veste unisexe
Sizes XSS-6YL

G^o PRINCIPALE/MATIÈRE PRINCIPALE
TWILL/SERGÉ 200 gr/m²
63%CO 35%CLY 2%EA

G^o SECONDARIO/MATIÈRE SECONDAIRE
INTERLOCK 200 gr/m²
100%PES

c/001 Nero/Noir
c/101 Bianco/Blanc

COOLMAX



HIDRÓFUGO
Stain-resistant



c/001 Nero/Noir



© 101 Bianco/Blanc



Jesús
SÁNCHEZ

Restaurante Cenador de Amós
CANTABRIA (SPAIN)

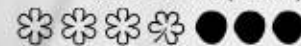



Classici
REINVENTATI
Réinventer les classiques

Hermanos
PADRÓN

Jonathan y Juan Carlos

Restaurante El Rincón de Juan Carlos
SANTA CRUZ DE TENERIFE (SPAIN)



REF. 933000 ICARO

Giacca unisex

Veste unisex

Taglia/Tailles XS-YL

COOLMAX





c/001 Nero/Noir
TWILL /TSERGÉ 210 gr/m²
65%PES 35%CO



COTONE EGIZIANO
COTON EGYPTIAN

c/101 Bianco/Blanc
TWILL/SERGÉ 170 gr/m²
100%CO

Juan Ma
SALGADO

Restaurante Dromo
BADAJOZ (SPAIN)



REF. 933100 ULISES

Giacca unisex

Veste unisex

Taglia/Tailles XS-YL

TWILL/SERGE 205 gr/m²

100%CO

c/T01 Bianco/Blanc

COOLMAX
Clima Cool, Stretch Fit



Tony
GARCÍA

Tony García Espacio Gastronómico
ALMERÍA (SPAIN)



REF. 934500 CIRCE

Giacca unisex/Veste unisex

Taglia/Tailles XS-YL

TWILL ELASTICIZZATO

SERGÉ EXTENSIBILE 206 gr/m²

59%CO 39%PES 2%EA

c/101 Bianco/Blanc

COOLMAX
Clima Intelligente



Yoshihazu
YANOME

Kaido Sushi Bar
VALENCIA (SPAIN)



REF. 933800 POSEIDÓN

Giacca unisex

Veste unisexe

Taglia/Tailles P-M-G-SG

TWILL/SERGÉ 210 gr/m²

65%PES 35%CO

c/001 Nero/Noir

c/101 Bianco/Blanc

COOLMAX



c/001 Nero/Noir



Yolanda
GARCÍA

Gastroconciencia
Gastroconsciousness
ALMERÍA (SPAIN)

c/101 Bianco/Blanc

Juan José
CARMONA

Restaurante Cávala
MÁLAGA (SPAIN)



REF. 933600 HELIOS

Giacca Uomo/Veste Homme

Taglia/Tailles XS-YL

SARGA/TWILL 210 gr/m²

65%PES 35%CO

c/101 Bianco/Blanc

c/001 Nero/Noir

COOLMAX
Clima fresco tutto il giorno



c/101 Bianco/Blanc





Patricio
UBEDA

Restaurante Blanca Brisa
ALMERIA (SPAIN)

c/001 Nero/Noir

Yaiza
RUANO

Pasticcera/Pastry chef
SEVILLA (SPAIN)



c/001 Nero/Noir

Ayoa
LÓPEZ

Restaurante Samsha
VALENCIA (SPAIN)



c/101 Bianco/Blanc

REF. 935500 ARTEMISA
Giacca Donna
Veste Femme
Taglia/Tailles XS-XXL
Twill/SERGÉ 210 gr/m²
65%PES 35%CO

COOLMAX





100% *Algodão Egípcio* / 100% *Egyptian Cotton*

100% Cotone Egiziano

Tessuto **premium** di alta qualità e comfort. La fibra lunga e il filato sottile consentono una maggiore densità del tessuto.

Il cotone egiziano è raccolto a mano riducendo così la pressione sulla fibra e proteggendola meglio. Per questo, i capi realizzati con questo tessuto sono morbidi, resistenti e durevoli.

Un'altra grande virtù del cotone egiziano è la sua facilità di manutenzione e di stiratura.

100 % coton égyptien

Tissu **premium** de haute qualité et confortable. Sa fibre longue et son fil fin lui confèrent une plus grande densité.

Le coton égyptien est récolté à la main. Cette technique permet de réduire la pression sur la fibre et la protège davantage. Les vêtements confectionnés à partir de ce tissu sont ainsi doux, résistants et durables.

Autre grande qualité du coton égyptien: il est facile à entretenir et à repasser.

Una dichiarazione
di design e comodità

Une ode au design et au confort

Juan
BENITES

Chef e consulente gastronomico
Chef et conseiller gastronomique
PERU

REF. 930005 ATÓN

Giacca unisex
Veste unisex
Taglia/Tailles XS-6YL
Twill/SERGÉ 170 gr/m²
100% CO

c/101 Bianco/Blanc

COOLMAX



Maria
ALCÁZAR

*Responsabile dell'Area Social della Selezione della
Cucina Spagnola/Responsable du domaine social de
la Selection Spagnole de cuisine*
MADRID (SPAIN)

REF. 933400 GALATEA

Giacca Donna

Veste Femme

Taglia/Tailles XS-XXL

TWILL/SERGÉ 170 gr/m²

100% CO

c/101 Bianco/Blanc

COOLMAX



COTONE EGIZIANO
COTON EGYPTIAN



Miguel Ángel

EXPÓSITO

Restaurante Retama
CIUDAD REAL (SPAIN)



REF. 932000 HERMES

Giacca Uomo
Veste Homme
Taglia/Tailles XS-YL
Twill/SERGÉ 170 gr/m²
100% CO

c/101 Bianco/Blanc

COOLMAX
Cotton



COTONE EGIZIANO
COTON ÉGYPTIEN



Richard ALCAYDE

Consulente di progetti gastronomici
Conseiller en projets gastronomiques
MÁLAGA (SPAIN)



REF. 932200 APOLO

Giacca unisex/Veste unisexe
Taglia/Tailles XS-YL
TWILL/SERGÉ 170 gr/m²
100%CO

c/101 Bianco/Blanc

COOLMAX



COTONE EGIZIANO
COTON EGYPTIAN



Rubén
FENOLLAR

Tradizione e avanguardia / Tradition et avant-gardisme
VALENCIA (SPAIN)



REF. 930002 ANHUR
Giacca unisex
Veste unisex
Taglia/Tailles XS-6YL
Twill/SERGE 170 gr/m²
100%CO

c/101 Bianco/Blanc

COOLMAX



COTONE EGIZIANO
COTON EGYPTIAN

T400 Technology
HIGH QUALITY



La fibra T400 è un nuovo tipo di fibra elastica basata su una tecnologia multicomponente che rivoluzionerà il comfort. Si tratta di un filamento differenziato che garantisce capi con una vestibilità permanente e un recupero della forma in tutte le direzioni. Per questo motivo è un'ottima opzione per capi elasticizzati che mantengono la forma e offrono un'estetica eccellente, consentendo una maggiore facilità di movimento. Offre elasticità e recupero in una fibra di poliestere e garantisce il comfort, la sensazione al tatto, la resistenza alle pieghe e la facilità di manutenzione dei tessuti contemporanei.

La fibre T400 est un nouveau type de fibre élastique reposant sur la technologie multicomposants. Cette dernière révolutionnera l'idée que l'on se fait du confort.

Il s'agit d'un filament différencié dont l'utilisation permet de confectionner des vêtements ajustés en permanence, sans jamais rien perdre de leur forme. Il s'agit donc d'une fibre de choix pour les vêtements élastiques ne se déformant pas et dont l'excellente esthétique offre une plus grande facilité de mouvement.

La présence de fibre de polyester apporte élasticité et récupération. Elle est également d'un grand confort, agréable au toucher, résistante aux plis et facilite l'entretien des tissus contemporains.

REF. 930017 LOKI

Giacca unisex/Veste unisexe

Taglia/Tailles XS-6YL

TWILL/SERGÉ 210 gr/m²

35%CO 35%PES 30%T400

c/101 Bianco/Biano

COOLMAX



Enrique
PÉREZ

Restaurante El Doncel
GUADALAJARA (SPAIN)





Jose Manuel MIGUEL

Beat Restaurant
ALICANTE (SPAIN)



REF. 930013 EREBO

Giacca unisex/Veste unisex
Taglia/Tailles XS-YL
Twill/SERGÉ 210 gr/m²
35%CO 35%PES 30%T400

c/101 Bianco/Blanc

COOLMAX



ELASTICITÀ
COMODITÀ
RESISTENZA
ÉLASTICITÉ
CONFORT
RÉSISTANCE



Fran
SEGURA

FranSegura&Co. Éclair & Postre
ALICANTE (SPAIN)



c/001 Nero/Noir

REF. 930007 VULCANO
Giacca unisex/Veste unisex
Taglia/Tailles XSS-YL
TWILL/SERGÉ 210 gr/m²
35%CO 35%PES 30%T400

c/001 Nero/Noir
c/101 Bianco/Blanc

COOLMAX



1400 Technology
HIGH QUALITY



**ELASTICITÀ
COMODITÀ
RESISTENZA**
ELASTICITE
CONFORT
RÉSISTANCE



Francisco
SÁNCHEZ

Presidente della selezione andalusa di Cucina
Président de la sélection andalouse de Cuisine
SEVILLA (SPAIN)



c/101 Bianco/Blanc

Lara
ROGUEZ

Restaurante Abarike
ASTURIAS (SPAIN)

REF. 930004 ERIS

Giacca Donna/Veste Femme

Taglia/Tailles XS-YL

TWILL/SERGÉ 210 gr/m²

35%CO 35%PES 30%T400

c/101 Bianco/Blanc

COOLMAX
Durable - Breathable - Moisture Wicking



T400 Technology

HIGH QUALITY





Kibe
MARTÍ

Arròzame
BALEARES (SPAIN)

REF. 930014 VALI

Giacca Uomo

Veste Homme

Taglia/Tailles XS-YL

TWILL/SERGÉ 210 gr/m²

35%CO 35%PES 30%T400

c/101 Bianco/Blanc

COOLMAX
Chiuso, fresco, resistente



ELASTICITÀ
COMODITÀ
RESISTENZA

ELASTICITE
CONFORT
RESISTANCE



Domi
VÉLEZ

El Horno de Vélez
Miglior Panettiere del mondo 2021
Élu meilleur boulanger du monde en 2021
SEVILLA (SPAIN)

REF. 930022 MOMO

Giacca unisex

Veste unisex

Taglia/Tailles XS-YL

TWILL/SERGÉ 210 gr/m²

35%CO 35%PES 30%T400

c/101 Bianco/Blanc

COOLMAX



T400 Technology

HIGH QUALITY



Rocio
ARROYO

Insegnante e pasticciera
Professeure et pâtissière
CIUDAD REAL (SPAIN)

REF. 930019 ZAYA

Giacca Donna
Veste Femme

Taglia/Tailles XS-YL

TWILL/SERGE 210 gr/m²
35%CO 35PES 30%T400

c/101 Bianco/Blanc

COOLMAX



ELASTICITÀ
COMODITÀ
RESISTENZA

ÉLASTICITÉ
CONFORT
RÉSISTANCE



c/001 Nero/Noir



Alessandro
MANNA

Casa Pomo d'Oro
BUDAPEST (HUNGARY)

Rocco
DE SANTIS

Ristorante Santa Elisabetta
FIRENZE (ITALY)



REF. 930006 ANUBIS

Giacca unisex/Veste unisex
Taglia/Tailles: XS-YL
Twill/SERGE 210 gr/m²
35%CO 35%PES 30%T400

c/001 Nero/Noir
c/101 Bianco/Blanc

COOLMAX



T400 Technology
HIGH QUALITY



ELASTICITÀ
COMODITÀ
RESISTENZA
ELASTICITY
COMFORT
RESISTANCE

c/101 Bianco/White





Oscar
GEADAS

G'Pousada Restaurante
PORTUGAL



c/101 Bianco/Blanc



Alfonso
ESCOLAR

Executive Chef / Chef exécutif
MADRID (SPAIN)

REF. 930018 HUBAL

Giacca unisex / Veste unisexe

Taglia / Tailles: XS-YL

TWILL / SERGE 210 gr/m²

35%CO 35%PES 30%T400

COOLMAX



1400 technology

HIGH QUALITY



**ELASTICITÀ
COMODITÀ
RESISTENZA**

ELASTICITÉ
CONFORT
RESISTANCE

c/001 Nero/Noir



Toño
RODRÍGUEZ

Cucina d'avanguardia
Gastronomie avant-gardiste
Restaurante La Era de los Nogales
ARAGÓN (SPAIN)



REF. 930008 ODIN

Giacca unisex
Veste unisexe
Taglia/Tailles XS-YL
DENIM/TISSU JEAN 180 gr/m²
67%CO 33%T400

C/838 Denim/Tissuu Jean

COOLMAX



T400 Technology
HIGH QUALITY



Stéphane
TOURNIE

Les jardins de L'Opera
TOULOUSE (FRANCE)



REF. 930026 FOBÉTOR

Giacca unisex/Veste unisex
Taglia/Tailles XSS-YL
DENIM/TESSU JEAN 180 gr/m²
67%CO 33%T400

c/838 Denim/Tissu Jean

COOLMAX
COOLMAX



**ELASTICITÀ
COMODITÀ
RESISTENZA**

ELASTICITE
CONFORT
RESISTANCE



A black and white photograph of a man with a beard and mustache, wearing a white long-sleeved shirt. He is looking directly at the camera with a slight smile, his hands clasped near his chin. The background is filled with large, tropical leaves, creating a pattern of light and shadow. The text is overlaid on the left side of the image.

Dettagli
**che fanno
la differenza**

Les détails qui font toute la différence



Samuel
NAVEIRA

Restaurante MU.NA
PONFERRADA (SPAIN)



REF. 930028 TYR

Giacca unisex

Veste unisex

Taglia/Tailles XS-YL

MICROFIBRA/MICROFIBRE

148 gr/m²

100%PES

c/101 Bianco/Blanc

COOLMAX





c/001 Nero/Noir



Jonathan
RODRÍGUEZ

Executive Chef/Chef exécutif
MADRID (SPAIN)

Quique
CERRO

Vice Presidente della Selezione di Gastronomia
Vice-président de la Sélection espagnole de cuisine
CASTILLA LA MANCHA (SPAIN)

REF. 930015 FORSETI

Giacca unisex

Veste unisex

Taglia/Tailles XS-6YL

THIN TWILL/SERGÉ FIN

150 gr/m²

54%PES 43%CO 3%EOL

c/001 Nero/Noir

c/101 Bianco/Blanc

COOLMAX[®]



c/101 Bianco/Blanc



Oscar
GARCÍA

Restaurante Baluarte
SORIA (SPAIN)



REF. 930024 SOKAR

Giacca unisex

Veste unisex

Taglia/Tailles XS-YL

TWILL STRUCTURE

SERGÉ STRUCTURE

215 gr/m²

50%CO 48%PES 2%EA

c/104 Blu navy/Bleu marine

COOLMAX



Paco
GARCÍA

Restaurante Kaliskka
GRANADA (SPAIN)

REF. 930021 AMÓN

Giacca unisex
Veste unisexe

Taglia/Tailles XS-YL
Twill STRUCTURE
SERGÉ ESTRUCTURÉ

215 gr/m²
50%CO 48%PES 2%EA

c/104 Blu navy/Bleu marine

COOLMAX





c/101 Bianco/Blanc

REF. 930012 JONSU

Giacca unisex

Veste unisex

Taglia/Tailles XS-6YL

OTTOMANO/TISSU OTTOMAN

150gr/m²

100%CO

c/101 Bianco/Blanc

c/117 Grigio perla/Gris perle



c/117 Grigio perla/Gris perle





QUALITÀ

come nostra scommessa e impegno

La qualité: notre pari, notre promesse

GASTROCHEF
by gary's

REF. 312200
Bomboletta spray idrorepellente
Spray déperlant

HIDRÓFUGO

Stain-resistant

PROTETTORE PER TESSUTI
PROTECTEUR DE TEXTILE

PREVIENE LA CRESCITA MICROBICA
FACILITA LA PULIZIA
PROLUNGA LA VITA UTILE DEL TESSUTO
DERMATOLOGICAMENTE TESTATO

PRÉVIENT L'APPARITION DE MICROBES
FACILITE LE NETTOYAGE
ALLONGE LA DURÉE DE VIE DU TEXTILE
TESTÉ SOUS CONTRÔLE DERMATOLOGIQUE



Antimicrobial



Liquid-repellent



Reusable



Stain-resistant



Machine washable



Invisible



Breathable



















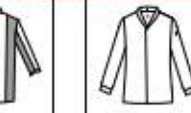





Anti-odour

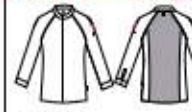

PRO
TEXGO
PROTECTEUR DE TEXTILE

DISEGNI E CARATTERISTICHE degli indumenti

CROQUIS ET CARACTÉRISTIQUES DES VÊTEMENTS

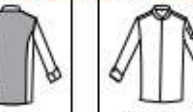
<p>930006 PAGE 39</p>  <ul style="list-style-type: none"> -Collo mao -Taschino sulla manica sinistra -Piqué sulla schiena -Chiusura con zip a vista -Linguetta per il grembiule -Lungo circa: 75 cm -Indumento U2: semi aderente <p>Col: mao -Poche sur la manche gauche -Piqué dans le dos -Fermeture à zip apparente -Ruban pour tablier -Longueur approximative: 75 cm Vêtement U2: semi-ajusté</p>	<p>930007 PAGE 32</p>  <ul style="list-style-type: none"> -Collo button down -Taschino sulla manica sinistra -Piqué sulla schiena -Bottoni a pressione nascosti -Fibbie decorative -Lungo circa: 75 cm -Indumento U2: semi aderente <p>Col: de chemise -Poche sur la manche gauche -Piqué dans le dos -Boutons pression cachés -Boutons décoratifs -Longueur approximative: 75 cm Vêtement U2: semi-ajusté</p>	<p>930008 PAGE 47</p>  <ul style="list-style-type: none"> -Collo mao -Taschino sulla manica sinistra -Piqué al centro della schiena -Bottoni a pressione nascosti -Linguetta per il grembiule -Lungo circa: 76 cm -Indumento U2: semi aderente <p>Col: mao -Poche sur la manche gauche -Piqué au centre du dos -Boutons pression cachés -Ruban pour tablier -Longueur approximative: 76 cm Vêtement U2: semi-ajusté</p>	<p>930011 PAGE 12</p>  <ul style="list-style-type: none"> -Collo mao -Taschino a sinistra -Tessuto interlock sulla manica e sulla schiena -Bottoni a pressione nascosti -Linguetta per il grembiule -Lungo circa: 76 cm -Indumento U2: semi aderente <p>Col: mao -Poche sur la gauche de la poitrine -Interlock sur les manches et les dos -Boutons pression cachés -Ruban pour tablier -Longueur approximative: 76 cm Vêtement U2: semi-ajusté</p>	<p>930012 PAGE 30</p>  <ul style="list-style-type: none"> -Collo e polsino button down -Taschino sulla manica sinistra -Sporre e piega sulla schiena -Bottoni a pressione nascosti -Lungo circa: 76 cm -Indumento U2: semi aderente <p>Col: et manchettes de chemise -Poche sur la manche gauche -Boutons pression cachés -Empoignement et pli sur le dos -Longueur approximative: 76 cm Vêtement U2: semi-ajusté</p>	<p>930013 PAGE 31</p>  <ul style="list-style-type: none"> -Collo mao -Piqué sulla manica e sulla schiena -Bottoni a pressione nascosti -Linguetta per il grembiule -Lungo circa: 76 cm -Indumento U2: semi aderente <p>Col: mao -Piqué sur les manches et dans le dos -Boutons pression cachés -Ruban pour tablier -Longueur approximative: 76 cm Vêtement U2: semi-ajusté</p>	<p>930014 PAGE 35</p>  <ul style="list-style-type: none"> -Collo smoking -Taschino sulla manica sinistra -Piqué sul fianco posteriore -Bottoni a pressione nascosti -Lungo circa: 76 cm -Indumento U2: semi aderente <p>Col: smoking -Poche sur la manche gauche -Piqué dans le dos -Boutons pression cachés -Longueur approximative: 76 cm Vêtement U2: semi-ajusté</p>	<p>930015 PAGE 47</p>  <ul style="list-style-type: none"> -Collo e polsino button down -Taschino sulla manica sinistra -Sporre sulla schiena -Bottoni a pressione nascosti -Lungo circa: 76 cm -Indumento U2: semi aderente <p>Col: et manchettes de chemise -Poche sur la manche gauche -Empoignement sur le dos -Boutons pression cachés -Longueur approximative: 76 cm Vêtement U2: semi-ajusté</p>
<p>930016 PAGE 6</p>  <ul style="list-style-type: none"> -Collo mao -Taschino sulla manica sinistra -Piqué sulla manica, spalla e schiena -Linguetta per il grembiule -Lungo circa: 75 cm -Indumento U2: semi aderente <p>Col: mao -Poche sur la manche gauche -Piqué sur les manches, épaules et dos -Ruban pour tablier -Longueur approximative: 76 cm Vêtement U2: semi-ajusté</p>	<p>930017 PAGE 30</p>  <ul style="list-style-type: none"> -Collo mao -Taschino sulla manica sinistra -Piqué sul fianco e sulla manica -Bottoni a pressione nascosti -Giacca a manica corta -Lungo circa: 75 cm -Indumento U2: semi aderente <p>Col: mao -Poche sur la manche gauche -Piqué sur le côté et sur les manches -Boutons pression cachés -Veste à manches courtes -Longueur approximative: 75 cm Vêtement U2: semi-ajusté</p>	<p>930018 PAGE 41</p>  <ul style="list-style-type: none"> -Collo mao -Taschino sulla manica sinistra -Piqué sul fianco e sulla manica -Bottoni a pressione nascosti -Linguetta per il grembiule -Lungo circa: 76 cm -Indumento U2: semi aderente <p>Col: mao -Poche sur la manche gauche -Piqué sur le côté et sur les manches -Boutons pression cachés -Ruban pour tablier -Longueur approximative: 76 cm Vêtement U2: semi-ajusté</p>	<p>930019 PAGE 37</p>  <ul style="list-style-type: none"> -Collo mao -Taschino sulla manica sinistra -Piqué sulla schiena -Bottoni a pressione nascosti -Margine di cucitura -Lungo circa: 70 cm -Indumento U2: semi aderente <p>Col: chemise -Poche sur la manche gauche -Piqué dans le dos -Boutons pression cachés -Couture latérale entrées -Longueur approximative: 70 cm Vêtement U2: semi-ajusté</p>	<p>930021 PAGE 49</p>  <ul style="list-style-type: none"> -Collo mao -Taschino sulla manica sinistra -Piqué sul fianco e sulla schiena -Bottoni a pressione nascosti -Risami di colore rosso -Lungo circa: 76 cm -Indumento U2: semi aderente <p>Col: mao -Poche sur la manche gauche -Piqué sur le côté et dans le dos -Boutons pression cachés -Détachants rouges -Longueur approximative: 76 cm Vêtement U2: semi-ajusté</p>	<p>930022 PAGE 36</p>  <ul style="list-style-type: none"> -Collo a camino -Taschino sulla manica sinistra -Piqué sul fianco posteriore -Bottoni a pressione nascosti -Polsino button down -Lungo circa: 76 cm -Indumento U2: semi aderente <p>Col: chemise -Poche sur la manche gauche -Piqué dans le dos -Boutons pression cachés -Manchettes de chemise -Longueur approximative: 76 cm Vêtement U2: semi-ajusté</p>	<p>930023 PAGE 5</p>  <ul style="list-style-type: none"> -Collo mao -Taschino sulla manica sinistra -Piqué sulla manica sinistra -Piqué sulla schiena -Bottoni a pressione nascosti -Lungo circa: 76 cm -Indumento U2: semi aderente <p>Col: chemise -Poche sur la manche gauche -Piqué dans le dos -Boutons pression cachés -Longueur approximative: 76 cm Vêtement U2: semi-ajusté</p>	<p>930024 PAGE 48</p>  <ul style="list-style-type: none"> -Collo mao -Taschino sulla manica sinistra -Piqué sul fianco posteriore -Chiusura con zip a vista -Linguetta per il grembiule -Lungo circa: 72 cm -Indumento U2: semi aderente <p>Col: mao -Poche sur la manche gauche -Piqué sur le côté dans le dos -Fermeture à zip apparente -Ruban pour tablier -Longueur approximative: 72 cm Vêtement U2: semi-ajusté</p>
<p>930026 PAGE 43</p>  <ul style="list-style-type: none"> -Collo button down -Taschino sulla manica sinistra -Piqué sulla manica sinistra -Bottoni a pressione nascosti -Lungo circa: 77 cm -Indumento U2: semi aderente <p>Col: de chemise -Poche sur la manche gauche -Piqué sur les manches et le dos -Boutons pression cachés -Longueur approximative: 77 cm Vêtement U2: semi-ajusté</p>	<p>930028 PAGE 45</p>  <ul style="list-style-type: none"> -Collo mao -Taschino sulla manica sinistra -Piqué sulla schiena -Bottoni a pressione nascosti -Lungo circa: 75 cm -Indumento U2: semi aderente <p>Col: mao -Poche sur la manche gauche -Piqué dans le dos -Boutons pression cachés -Longueur approximative: 75 cm Vêtement U2: semi-ajusté</p>	<p>932000 PAGE 27</p>  <ul style="list-style-type: none"> -Collo mao a doppiopetto -Taschino sulla manica sinistra -Piqué sulla schiena -Bottoni a pressione nascosti -Lungo circa: 75 cm -Indumento U2: semi aderente <p>Col: mao croisé -Poche sur la manche gauche -Piqué dans le dos -Boutons pression cachés -Longueur approximative: 75 cm Vêtement U2: semi-ajusté</p>	<p>932200 PAGE 28</p>  <ul style="list-style-type: none"> -Collo mao -Taschino a sinistra e sulla manica sinistra -Piqué sul giromanica -Bottoni a pressione nascosti -Lungo circa: 75 cm -Indumento U2: semi aderente <p>Col: mao -Poche sur la manche gauche et sur le côté de la poitrine -Piqué sur l'emmanchure -Boutons pression cachés -Longueur approximative: 75 cm Vêtement U2: semi-ajusté</p>	<p>933000 PAGE 14</p>  <ul style="list-style-type: none"> -Collo mao a doppiopetto -Taschino sulla manica sinistra -Piqué sulla schiena -Bottoni a pressione nascosti -Lungo circa: 74 cm -Indumento U2: semi aderente <p>Col: mao croisé -Poche sur la manche gauche -Piqué dans le dos -Boutons pression cachés -Longueur approximative: 74 cm Vêtement U2: semi-ajusté</p>	<p>933100 PAGE 16</p>  <ul style="list-style-type: none"> -Collo mao -Taschino sulla manica sinistra -Piqué sulla schiena -Bottoni a vista -Lungo circa: 74 cm -Indumento U2: semi aderente <p>Col: mao -Poche sur la manche gauche -Piqué dans le dos -Boutons visibles -Longueur approximative: 74 cm Vêtement U2: semi-ajusté</p>	<p>933400 PAGE 26</p>  <ul style="list-style-type: none"> -Collo mao a doppiopetto -Taschino a sinistra e sulla manica sinistra -Piqué sulla schiena -Bottoni a pressione nascosti -Lungo circa: 72 cm -Indumento U2: semi aderente <p>Col: mao croisé -Poche sur la manche gauche et sur la gauche de la poitrine -Piqué dans le dos -Boutons pression cachés -Longueur approximative: 72 cm Vêtement U2: semi-ajusté</p>	<p>933600 PAGE 20</p>  <ul style="list-style-type: none"> -Collo mao -Taschino sulla manica sinistra -Piqué sul fianco posteriore -Bottoni a pressione nascosti -Lungo circa: 74 cm -Indumento U2: semi aderente <p>Col: mao -Poche sur la manche gauche -Piqué sur le côté dans le dos -Boutons pression cachés -Longueur approximative: 74 cm Vêtement U2: semi-ajusté</p>

933800 PAGE 16



-Collo a doppiopetto
-Taschino sulla manica sinistra
-Piqué sulla schiena
-Chiusura con cintura regolabile
-Lungo circa: 74 cm
-Indumento H2: semi aderente

-Colloletti cavi
-Pochette sur la manche gauche
-Piqué dans le dos
-Fermeture avec sangle de réglage
-Longueur approximative: 74 cm
-Vêtement H2: semi ajusté

934500 PAGE 17



-Collo man a doppiopetto
-Taschino sulla manica sinistra
-Piqué sul fianco e sullo spallone
-Bottoni a pressione nascosti
-Lungo circa: 75 cm
-Indumento H2: semi aderente

-Col man croisé
-Pochette sur la manche gauche
-Piqué sur le côté et l'épaule
-Boutons pression cachés
-Longueur approximative: 75 cm
-Vêtement H2: semi ajusté

935500 PAGE 21



-Collo man
-Taschino sulla manica sinistra
-Piqué sul fianco
-Bottoni a pressione nascosti
-Lungo circa: 71 cm
-Indumento D2: semi aderente

-Col man
-Pochette sur la manche gauche
-Piqué sur le côté
-Boutons pression cachés
-Longueur approximative: 71 cm
-Vêtement F2: semi ajusté

U1 INDUMENTI ADERENTI DA UOMO
U2 INDUMENTI SEMIADERENTI DA UOMO
U3 INDUMENTI COMODI DA UOMO

H1 VÊTEMENTS AJUSTÉS POUR HOMME
H2 VÊTEMENTS SEMI-AJUSTÉS POUR HOMME
H3 VÊTEMENTS AMPLES POUR HOMME

D1 INDUMENTI ADERENTI DA DONNA
D2 INDUMENTI SEMIADERENTI DA DONNA
D3 INDUMENTI COMODI DA DONNA

F1 VÊTEMENTS AJUSTÉS POUR FEMME
F2 VÊTEMENTS SEMI-AJUSTÉS POUR FEMME
F3 VÊTEMENTS AMPLES POUR FEMME

Misure Tableau de mensurations

Aiutano le taglie appropriate ad ogni persona.

Les mensurations sont prises de façon individuelle afin d'attribuer la taille adéquate.

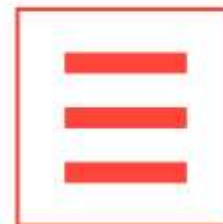

CM. MISURE BASE UOMO E UNISEX / TAILLES HOMME STANDARD ET UNISEXE

TAGLIE	TAILLES	P			M			G			SG					
		XSS	XS	S	M	L	XL	XXL	YL							
		40	42	44	46	48	50	52	54	56	58	60	62	64	66	68
PETTO	POITRINE	78-81	82-85	86-89	90-93	94-97	98-101	102-105	106-109	110-113	114-117	118-121	122-125	126-129	130-133	134-137
VITA	TAILLE	66	70	74	78	82	86	90	94	98	102	106	110	114	118	122
FIANCHI	HANCHES	78	82	86	90	94	98	102	106	110	114	118	122	126	130	134



CM. MISURE BASE DONNA / TAILLES FEMME STANDARD

TAGLIE	TAILLES	P			M			G			SG						
		XSS	XS	S	M	L	XL	XXL	YL								
		34	36	38	40	42	44	46	48	50	52	54	56	58	60	62	64
PETTO	POITRINE	78-81	82-85	86-89	90-93	94-97	98-101	102-105	106-109	110-113	114-117	118-121	122-125	126-129	130-133	134-137	134-137
VITA	TAILLE	60	64	68	72	76	80	88	88	92	96	100	104	108	112	116	120
FIANCHI	HANCHES	84	88	92	96	100	104	112	112	116	120	124	128	132	136	140	144

Hai un'idea?

Vous avez un projet?

Hai un'idea?

Creiamo qualsiasi disegno che immagini. Stampe personalizzate, modelli personalizzati, personalizzazione di passamaneria, ricamo o serigrafia. La fantasia non ha limiti e insieme possiamo realizzare la tua idea.

Nous donnons vie à toutes vos envies. Imprimés personnalisés, étalons de mesure, personnalisation d'accessoires, broderies ou sérigraphies. L'imagination manque de limite et, ensemble, nous pouvons faire de vos idées une réalité.



Specializzati nella personalizzazione di abbigliamento da lavoro

Nous sommes spécialistes des vêtements professionnels

Il nostro team di esperti modellisti e designer è specializzato nello sviluppo di dossier con le proposte più adatte alle tue esigenze e alla tua immagine aziendale, ora con l'aiuto delle nuove tecnologie con lo sviluppo di prototipi e disegni in 3D. Puntiamo su tessuti e abbigliamento di qualità. Un abbigliamento personalizzato farà la differenza nella tua attività.

Les experts stylistes et modélistes de notre équipe élaboreront un dossier dans lequel vous trouverez toutes les propositions qui répondent le plus à vos besoins et respectent votre image de marque. Ils font également usage des nouvelles technologies pour développer des prototypes et des designs en 3D. Qu'il s'agisse de la confection ou du choix des tissus, nous misons sur la qualité. Nous sommes aussi convaincus que des tenues personnalisées vous permettront de vous démarquer au sein de votre environnement professionnel.





Scorpi di più

Pour en savoir plus

Consulta i nostri cataloghi, puoi trovare tantissime collezioni per ogni settore.

Consultez notre catalogue. Vous y retrouverez toutes nos collections. Il y en a une pour chaque secteur

gary's
COLEGIO

gary's
HORECA

gary's
SANIDAD

gary's
BEAUTY & HAIR

gary's
Sustreria

DENIM
gary's

gary's
Colección Camisas

SKECHERS
WORK
FOOTWEAR

gary's
RED LINE

gary's
naturewear

garysworkwear.com

Ricami di più

Broderies personnalisées

Vuoi personalizzare i tuoi capi con un ricamo? Possiamo ricamare qualsiasi tipo di abbigliamento da lavoro. Grazie ai nostri macchinari all'avanguardia e al nostro team specializzato, puoi ricamare il tuo logo o frasi con alta qualità.

Vous songez à personnaliser votre tenue avec une broderie ? Nous brodons tous types d'uniformes professionnels. Grâce à du matériel dernière génération et à notre équipe d'experts, vous pourrez faire broder votre logo ou une phrase. Le tout avec qualité.



L'azienda

Il continuo impegno per l'innovazione e la qualità (sia nel servizio che nei materiali) ha mantenuto l'azienda in costante sviluppo alla ricerca dell'eccellenza, ottenendo così materie prime di alto livello nelle mani di uno straordinario team di persone impegnate nell'azienda.

Nel 2019, dopo essere diventata leader del settore a livello nazionale e aver intrattenuto per anni relazioni commerciali al di fuori della Spagna, l'azienda ha iniziato a internazionalizzarsi su larga scala. La nostra missione è progettare e produrre abbigliamento da lavoro professionale, offrendo un ottimo servizio e un'ampia gamma di prodotti per i lavoratori più esigenti.

Gary's è il principale riferimento nella moda professionale, sia a livello nazionale che internazionale. Fornisce differenziazione in termini di design, comfort, protezione e durata a tutti i lavoratori che indossano i suoi capi.

L'azienda si proietta nel futuro preservando i valori della propria identità.

L'ECCELLENZA NEL LAVORO È L'ESSENZA DI UNI-FORMES GARY'S, ATTRAVERSO I VALORI CHE LA GUIDANO: INTEGRITÀ, QUALITÀ, INNOVAZIONE, VICINANZA E PASSIONE.

Siamo una scommessa sicura per tutti i professionisti che vogliono vestirsi in modo comodo, moderno e sicuro al lavoro, tutti i giorni.

Seguici sui social

Suivez-nous sur les réseaux sociaux



Notre entreprise

Notre engagement constant en faveur de l'amélioration et de la qualité --(de nos services comme des matériaux que nous choisissons), a conduit notre entreprise à se développer de façon continue dans le but d'atteindre l'excellence. Notre extraordinaire équipe, engagée ainsi à nos côtés, donne vie à des matières premières de haute qualité.

En 2019, après être devenus les leaders de notre secteur au niveau national, et après avoir développé des relations commerciales au-delà des frontières espagnoles, nous avons amorcé l'internationalisation de notre entreprise à grande échelle. Nous nous donnons pour mission de créer et confectionner des uniformes tout en proposant un excellent service et un large catalogue de produits pour les professionnels les plus exigeants.

Gary's est la référence en matière de mode professionnelle, sur la scène nationale autant que sur la scène internationale. Le design, le confort, la protection et la durabilité : voilà tout ce qui distingue les professionnels qui font le choix de porter nos créations.

Aujourd'hui, notre entreprise se concentre sur l'avenir en n'oubliant jamais les valeurs qui fondent son identité.

L'EXCELLENCE PROFESSIONNELLE CONSTITUE L'ESSENCE MÊME DES UNIFORMES GARY'S. UN ENGAGEMENT PORTÉ PAR DES VALEURS: L'INTÉGRITÉ, LA QUALITÉ, L'INNOVATION, LA PROXIMITÉ ET LA PASSION.

Nous sommes une valeur sûre pour tous les professionnels qui souhaitent porter des uniformes confortables et modernes sur leur lieu de travail.

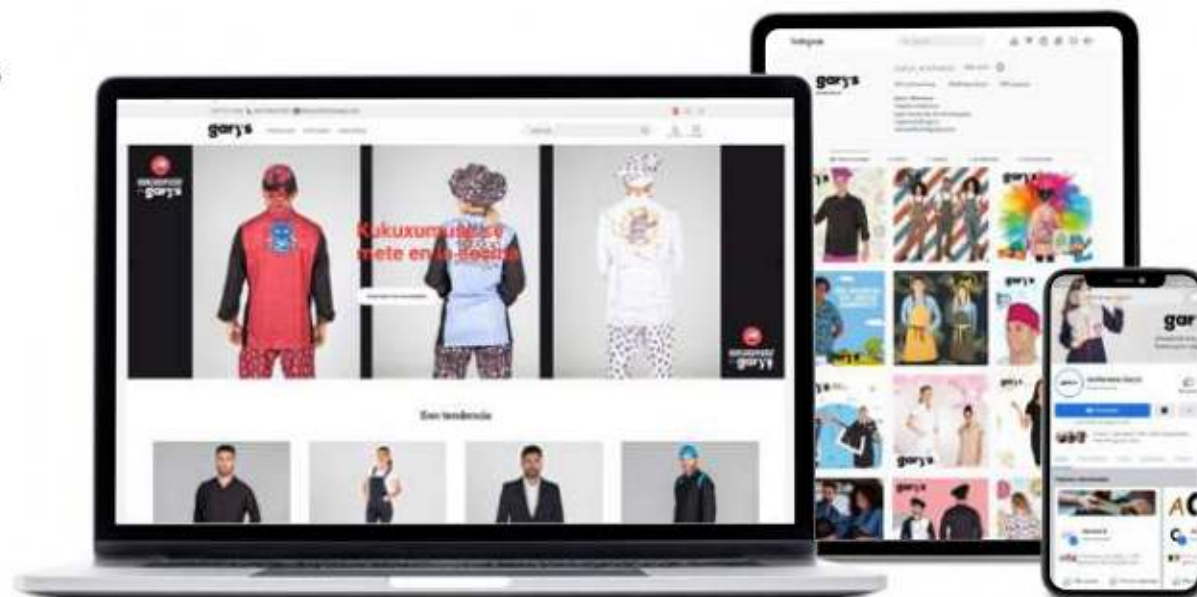



*Ti aiutiamo a distinguerti, a trasmettere i valori del tuo marchio.
Nous vous aidons à mettre en lumière et à transmettre les valeurs de votre entreprise.*

gary's Happier
Workplaces

© Uniformes Gary's

La riproduzione totale o parziale di questo catalogo, così come il suo trattamento in qualsiasi forma e con qualsiasi mezzo, è vietata senza l'espressa autorizzazione scritta della società titolare del copyright.

Toute reproduction totale ou partielle de ce catalogue, comme sa modification sous quelque forme ou par quelques moyens que ce soit est strictement interdite sans autorisation préalable et écrite de l'entreprise titulaire des droits d'auteur.



8429935474854

gary's WORKWEAR

SETTORE ALBERGHIERO E CUCINA



garysworkwear.com

Happier Workplaces

Presentiamo la nuova collezione per il settore alberghiero e cucina con modelli rinnovati e attuali, insieme a dei capi basic. Colori, forme e modelli si adattano a un settore che richiede una moda urban e funzionale.

Tra le varie novità e sempre più coscienti della necessità di un cambiamento per soddisfare l'impegno intrapreso verso il nostro pianeta e le sue risorse, siamo orgogliosi di presentare la nostra nuova linea Gary's Naturewear.

Ed ecco un'anteprima della nostra linea, con capi altamente resistenti ed estremamente comodi.

HoReCa



RIF.	PAG.	RIF.	PAG.
100800	78	157400	170
100900	82	157500	102
102100	80	157600	97
102200	80	157700	98
102300	81	157800	97
102400	81	158100	110
102500	79	158400	99
102600	79	158500	98
102800	83	158600	171
102900	83	158700	101
103100	84	158800	100
103200	85	159100	126
103300	82	159200	111
107000	146	159300	126
108000	146	159500	171
111000	146	159600	172
111600	152	159700	156
111800	152	159800	174
111900	155	159900	176
115000	140	161000	138
116000	124	161100	105
116100	123	175100	135
116300	125	175200	135
116400	125	176000	95
117000	130	176800	95
117100	129	177400	94
118000	116	180000	132
120000	120	181000	132
120300	131	182000	113
120600	121	182200	112
123000	140	183000	114
123100	139	184100	134
124000	142	191000	118
125000	141	191100	136
126100	141	191200	119
126200	143	200100	190
126300	142	200200	191
126400	145	202000	150
126500	144	202200	151
127000	115	202300	93
149100	108	203200	92
153300	136	203400	89
153700	137	203500	92
156100	108	203600	93
156300	133	204500	94
156400	106	204700	87
156600	108	205400	87
156700	109	205900	166
157300	103	206100	90

RIF.	PAG.	RIF.	PAG.	RIF.	PAG.	RIF.	PAG.	RIF.	PAG.
206200	91	448400	193	777900	89	944300	48	963800	166
206300	89	448600	181	778500	94	944600	40	963900	166
206400	168	448800	181	778600	88	944800	42	965000	71
212300	156	448900	179	778900	166	944900	38	990000	72
212400	167	449100	196	779500	168	945100	40	993100	62
212500	148	449200	183	791500	86	945200	41	993300	62
212600	149	449300	180	791600	90	945400	39	993400	67
243900	168	449700	170	791700	91	945500	28	994600	67
261100	169	450000	200	851100	74	945800	45	994700	65
310100	108	450100	165	851500	74	946300	44	994800	65
311100	37	450200	160	852600	77	946600	21	997000	72
321000	198	450300	192	852700	77	946700	20	998000	72
322000	198	460000	200	852900	77	946800	25	113F00	95
323000	199	470000	200	853100	77	947100	24	115AT0	140
324000	199	486000	141	906100	34	947200	25	116BC0	122
325000	199	486200	141	907000	32	947300	29	11745B	128
329000	201	614800	156	908000	32	947400	12	117B00	128
330600	106	620100	68	910000	33	947500	15	118B00	117
350100	200	620200	68	911000	46	947600	14	118G00	116
370100	157	620700	69	912000	43	947700	23	118GB0	117
400000	197	645400	47	914000	43	947800	31	1200Z0	198
401000	197	652400	47	915000	46	947900	14	182V00	113
405000	197	700600	54	916000	46	948100	21	445V00	182
405100	196	700700	61	918000	37	948200	29	446V00	183
410000	195	700900	59	919100	51	948400	40	447V00	183
410100	195	701200	52	930400	36	948500	16	4481V0	182
415000	194	701300	61	930500	44	948600	16	4482V0	183
416000	195	701500	61	930700	50	948700	31	771L00	60
420000	195	701700	61	930800	35	948800	22	7733G0	57
421000	195	701800	88	931000	33	949100	22	773G00	56
422000	195	702300	61	931400	35	949200	18	917A00	46
435000	196	702400	55	940100	9	949300	18		
440000	196	703400	165	940200	4	949500	26		
441100	185	703500	160	940300	6	949600	11		
441200	184	703600	161	940400	8	949700	30		
441400	185	750200	203	940500	7	949800	27		
441500	165	770000	60	941000	49	949900	13		
441600	160	771000	60	942100	42	950100	154		
441700	161	772000	58	942200	45	950200	154		
441800	186	772500	55	942300	11	953000	68		
445100	152	773000	58	942400	164	960000	70		
445200	155	773300	59	942500	163	961000	70		
445300	152	775000	60	942600	162	963000	69		
446100	197	776000	60	942700	160	963200	63		
446200	197	777100	60	942800	30	963300	63		
447100	188	777200	60	942900	163	963400	69		
447500	192	777500	61	943100	161	963500	69		
447800	189	777700	88	944100	16	963600	73		
447900	189	777800	86	944200	16	963700	73		

Giacche per la cucina	04
Pantaloni per la cucina	52
Settore alberghiero	62
Pantaloni per il settore alberghiero	86
Grembiuli e casacche	96
Naturewear	158
Cappelli e accessori	178
Industria Gary's	202
Schizzi e caratteristiche	210

garysworkwear.com

RIF. 940200 Vargas
Uomo
Jeans elasticizzati 260 g/m²
65%PES 32%CO 3%EA
XS-YL
c/825 Grigio



 aerosilver





Giacche per la cucina

Casual

gary's WORKWEAR

RIF. 940300 Suárez
Uomo
Serge 206 g/m²
59%PES 39%CO 2%EA
XS-YL
c/001 Nero



 aerosilver



RIF. 940500 Soler
Uomo
Serge 206 g/m²
59%PES 39%CO 2%EA
XS-YL
c/001 Nero
c/101 Bianco



aerosilver



RIF. 940400 Cano
Uomo
Serge 206 g/m²
59%PES 39%CO 2%EA
XS-YL
c/001 Nero
c/101 Bianco



aerosilver





RIF. 940100 Gil
Uomo
Serge 206 g/m²
59%PES 39%CO 2%EA
XS-YL
c/001 Nero
c/101 Bianco

Giacche per la cucina **Microfibra**



RIF. 949600 Kitchen
Unisex
MICROFIBRA 148 g/m²
100%PES
XS-YL
c/001 Nero



 aerosilver



RIF. 942300 Torres
Unisex
MICROFIBRA 148 g/m²
100%PES
XS-YL
c/001 Nero



 aerosilver





RIF. 947400 Militare
Unisex
MICROFIBRA 148 g/m²
100%PES
XS-YL
c/101 Bianco



aerosilver



MY
Kitchen
MY
Rules



RIF. 949900 Cleaver
Unisex
MICROFIBRA 148 g/m²
100%PES
XS-YL
c/001 Nero



aerosilver

RIF. 947600 Lelva
Unisex
MICROFIBRA 148 g/m²
100%PES
XS-YL



aerosilver

CARATTERISTICHE DELLA MICROFIBRA

- Antibatterica.
- Repellente contro i liquidi.
- Altamente traspirante.
- Non è necessaria la stiratura.
- Non si alterano i colori né i disegni.
- Migliore tolleranza agli schizzi di candeggina rispetto al cotone.
- Si asciuga molto velocemente.
- Lavabile a 90 °C

c/4117 Ragno bianco



c/4118 Time to eat



RIF. 947900 Melanzane
Unisex
c/4115 Melanzane
MICROFIBRA 148 g/m²
100%PES
XS-YL



aerosilver

Kitchen Jackets.

c/4116 Coco



c/4112 Tattoo



aerosilver

RIF. 947500 Ayala
Unisex
MICROFIBRA 148 g/m²
100%PES
XS-YL

c/105 Rosso



c/139 Grigio antracite



c/115 Turchese



aerosilver



c/101 Bianco



c/127 Pistacchio



Microfibra

100%PES 148 g/m²

+ Aerosilver.

RIF. 944100 VIDAL UOMO M. LUNGA

Taglie: XS-5YL

RIF. 944200 RIVERA UOMO M. CORTA

Taglie: XS-YL

RIF. 948500 MIRANDA DONNA M. LUNGA

Taglie: XS-YL

RIF. 948600 PAZ DONNA M. CORTA

Taglie: XS-YL

+ Plus sizes

2YL-3YL-4YL-5YL

(Rif. 944100 c/101 Bianco e c/001 Nero)

c/001 Nero





Tutti i colori disponibili da uomo e da donna a manica corta o lunga

aerosilver

gary's WORKWEAR

RIF. 949300 Civera
Giacca manica corta
Unisex
Chambray rombi 120 g/m²
70%CO 30%PES
XS-YL
c/1131 Grigio antracite



 aerosilver

RIF. 949200 Silva
Giacca manica lunga
Unisex
Chambray rombi 120 g/m²
70%CO 30%PES
XS-YL
c/1131 Grigio antracite



 aerosilver





Unisex.

RIF. 946700 Castro
Unisex
Jeans 190 g/m²
65%CO 32%PES 3%EA
XS-YL
c/831 Texas navy



RIF. 946600 Morán
Uomo
Jeans 190 g/m²
65%CO 32%PES 3%EA
XS-YL
c/831 Texas navy

RIF. 948100 Valera
Donna
Jeans 190 g/m²
65%CO 32%PES 3%EA
XS-YL
c/831 Texas navy



RIF. 949100 Ponce
Unisex
Jeans 160 g/m²
98%CO 2%EA
XS-YL
c/834 Zaffiro



 aerosilver



RIF. 948800 Santana
Unisex
Jeans 160 g/m²
98%CO 2%EA
XS-YL
c/834 Zaffiro



 aerosilver



RIF. 947700 Ventura
Unisex
Jeans délavé 220 g/m²
98%CO 2%EA
XS-YL
c/833 Cowboy blu

A man with a beard and short dark hair is smiling and standing in front of a wooden cabinet. He is wearing a dark green, long-sleeved shirt with a high collar and matching green trousers. The cabinet behind him has two doors with a light-colored, textured fabric panel and a large black circular handle. The cabinet is framed by a dark wood with intricate carvings. The background wall is a neutral grey color.

RIF. 947100 Durán
Unisex
Satin elasticizzato 245 g/m²
61%CO 37%PES 2%EA
XS-YL
c/149 Verde cachi

RIF. 946800 Marcos
Unisex
Jeans 128 g/m²
100%CO
XS-YL
c/832 Chambray blu



RIF. 947200 Ferrer
Unisex
Satin elasticizzato 245 g/m²
61%CO 37%PES 2%EA
XS-YL
c/153 Blu petrolio



 aerosilver

RIF. 949500 Velasco
Unisex
Serge 210 g/m²
65%PES 35%CO
XS-YL



aerosilver



c/139 Grigio antracite

c/127 Pistacchio



c/115 Turchese



Chef jackets.



aerosilver

c/001 Nero



c/101 Bianco

RIF. 949800 Abades
Unisex
Microfibra Elastik 155 g/m²
99%PES 1%EA
XS-YL



c/5101 Olive

c/5103 Mimetico

c/5102 Peperoncini

RIF. 945500 Goya
Unisex
Serge 210 g/m²
100%CO
XS-YL



 aerosilver

RIF. 947300 Legni
Unisex
Serge 210 g/m²
100%CO
XS-YL
c/5107 Legni



aerosilver

RIF. 948200 Catrina
Unisex
Serge 210 g/m²
100%CO
XS-XXL
c/5108 Catrina



aerosilver



c/001 Nero

RIF. 949700 Crespo
Giacca uomo
Microfibra Elastik 155 g/m²
99%PES 1%EA
XS-YL

RIF. 942800 Iza
Giacca donna
Microfibra Elastik 155 g/m²
99%PES 1%EA
XS-YL



aerosilver

c/101 Bianco

RIF. 947800 Andreu
Uomo
Serge 210 g/m²
65%PES 35%CO
XS-YL



c/101 Bianco



aerosilver

RIF. 948700 Medina
Donna
Serge 210 g/m²
65%PES 35%CO
XS-YL



c/001 Nero

I due colori disponibili da uomo e da donna.



RIF. 907000 M. lunga
Unisex
Serge 200 g/m²
65%PES 35%CO
XS-YL
c/101 Bianco

RIF. 908000 M. Corta
Unisex
Serge 200 g/m²
65%PES 35%CO
XS-YL
c/101 Bianco

RIF. 910000
Unisex
Serge 200 g/m²
65%PES 35%CO
XSS-YL
c/101 Bianco



RIF. 931000
Unisex
Serge 200 g/m²
65%PES 35%CO
XSS-YL
c/101 Bianco



**Antimacchie
Teflon**



 **aerosilver**



c/001 Nero

c/112 Bordeaux

RIF. 906100
Unisex
Serge 200 g/m²
65%PES 35%CO
XSS-YL

RIF. 930800 Paris
Unisex
Serge 200 g/m²
65%PES 35%CO
XSS-YL
c/001 Nero



aerosilver

RIF. 931400
Unisex
Serge 200 g/m²
65%PES 35%CO
XS-YL
c/112 Bordeaux





aerosilver

RIF. 930400 Niza (senza bottoni)
Uomo
Serge 200 g/m²
65%PES 35%CO
XS-YL

c/001 Nero



c/101 Bianco



c/101 Bianco



c/001 Nero



RIF. 918000 Niza (senza bottoni)
Donna
Serge 200 g/m²
65%PES 35%CO
XS-YL



**Completa la tua
giacca
con il pack da
10 bottoni.**

RIF. 311100 Pack 10
Bottoni a sfera
Accessorio per
giacca da cucina

RIF. 944900 Aragón
Unisex
Serge 200 g/m²
65%PES 35%CO
XS-YL
c/101 Bianco



**Costine basic
su polsini e sul
giromanica della schiena**

A man with a beard and a dark cap is leaning on a white marble bar counter. He is wearing a blue patterned long-sleeved shirt. In the background, there is a bar with various bottles and a coffee machine. A red speech bubble is overlaid on the right side of the image.

RIF. 945400 Alcaraz
Unisex
Popeline 116 g/m²
65%PES 35%CO
XS-YL
c/1103 Blu indaco punteggiato

RIF. 944600 Abad
Uomo
Serge 200 g/m²
65%PES 35%CO
XS-5YL

RIF. 948400 Dana
Donna
Serge 200 g/m²
65%PES 35%CO
XS-YL

RIF. 945100 Luque
Unisex
Serge 200 g/m²
65%PES 35%CO
XS-YL

+ Plus sizes:
2YL-3YL-4YL-5YL

c/001 Nero

c/101 Bianco

c/001 Nero

c/101 Bianco



 aerosilver

I due colori disponibili da uomo e da donna.

RIF. 945200 Ortiz
Unisex
Serge 200 g/m²
65%PES 35%CO
XS-YL

c/001 Nero

c/101 Bianco

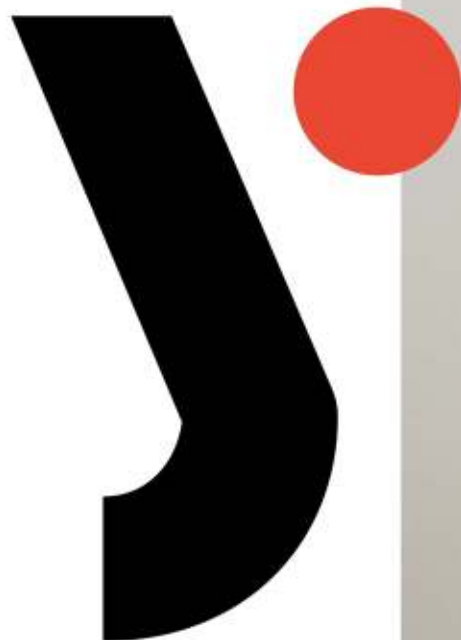

RIF. 944800 Marín (giacca uomo)
RIF. 942100 Varela (giacca donna)
Serge 200 g/m²
65%PES 35%CO
XS-YL



aerosilver

c/001 Nero

c/101 Bianco

c/001 Nero

c/101 Bianco



RIF. 912000 M. lunga
Unisex
Serge 200 g/m²
65%PES 35%CO
XS-YL

RIF. 914000 M. Corta
Unisex
Serge 200 g/m²
65%PES 35%CO
XS-YL



c/104 Navy

c/112 Borde-
aux

c/001 Nero

RIF. 946300 Egea
Unisex
Serge 200 g/m²
65%PES 35%CO
XS-YL
c/141 Crema



 aerosilver

RIF. 930500 Nápoles
Unisex
Serge 200 g/m²
65%PES 35%CO
XS-YL
c/101-001 Nero



 aerosilver

RIF. 945800 Serna
Uomo
Serge 200 g/m²
65%PES 35%CO
XS-YL
c/101 Bianco



 aerosilver

RIF. 942200 Lara
Donna
Serge 200 g/m²
65%PES 35%CO
XS-YL
c/101 Bianco



RIF. 917A00
Unisex
Popeline 120 g/m²
65%PES 35%CO
XSS-YL
c/001 Nero



Disponibile in tre tessuti.

RIF. 916000
Unisex
Popeline 120 g/m²
65%PES 35%CO
XSS-YL
c/001 Bianco

RIF. 911000
Unisex
Serge 200 g/m²
65%PES 35%CO
XSS-YL
c/001 Nero

RIF. 915000
Unisex
Navetta 145 g/m²
65%PES 35%CO
XSS-YL
c/001 Nero





RIF. 645400
Donna
Serge 200 g/m²
65%PES 35%CO
XSS-YL
c/1202 Bianco-Quadretti navy

RIF. 652400
Donna
Serge 200 g/m²
65%PES 35%CO
XSS-YL
c/1202 Bianco-Quadretti navy



RIF. 944300 Casal
Unisex
Jeans délavé 200 g/m²
100%CO
XS-YL
c/805 Jeans délavé

A man with a beard and a bright green chef's hat stands in a restaurant. He is wearing a white chef's jacket with a visible velcro closure and green and black vertically striped pants. He is smiling and has his hands in his pockets. The background is a wall made of dark, textured wooden planks. To the left, there is a small shelf with books. To the right, a dining table with a white tablecloth and a wooden chair is visible.

c/101 Bianco

Chiusura con velcro.

RIF. 941000
Unisex
Serge 200 g/m²
65%PES 35%CO
XSS-YL

C/105
Rosso



C/125
Fucsia



C/119
Malva



C/136
Viola



C/115
Turchese



C/121
Verde oliva



C/128
Senape



C/117
Grigio perla



C/139
Grigio antracite



RIF. 930700 Teramo
Uomo
Serge 200 g/m²
65%PES 35%CO
XS-YL



Tutti i colori disponibili da
uomo e da donna.



RIF. 919100 Catania
Donna
Serge 200 g/m²
65%PES 35%CO
XS-YL





C/5114 SABOR



C/5127 CLEAVER



c/5115 Equazione



c/5116 Fornello



C/5121 KITCHEN

100% Microfibra

RIF. 701200
Unisex
XS-YL
100%PES 148 g/m²
Regular fit



C/5117 FIAMME



C/5118 MEZCLUM

Pantaloni



C/4112 TATTOO



C/4115 MELANZANE



C/4114 MILITARE



C/4113 RAGNO GRIGIO



C/4116 COCO



C/4111 ARAZZO



C/5111 CARPE



C/4104 UOVA ALL'OCCHIO DI BUE



C/5112 GAMBERI



C/5113 ICONE

100% Microfibra

RIF. 700600

Unisex

XS-YL

100%PES 148 g/m²

Regular fit

+ Plus sizes

2YL-3YL-4YL-5YL

(Rif. 700600 c/101 Bianco
e c/001 Nero)



C/101 BIANCO



C/001 NERO



C/139 GRIGIO ANTRACITE



C/115 TURCHESE



C/107 CELESTE



C/104 NAVY



C/108 VERDE



C/127 PISTACCHIO



C/119 MALVA



C/105 ROSSO



C/112 BORDEAUX



C/138 LAMPONE



C/001 NERO



C/101 BIANCO

Premaman

RIF. 772500
Donna
XS-XXL
Piqué 167 g/m²
65%PES 35%CO
Straight leg



C/101 BIANCO



C/001 NERO



C/142 SABBIA

gary's

 WORKWEAR

100% Microfibra

RIF. 702400 TASCIA LATERALE
Donna
XS-YL
100%PES 148 g/m²
Regular fit



C/104 NAVY



C/115 TURCHESE



C/119 MALVA



C/001 NERO



C/104 NAVY



C/103 BLU



C/107 CELESTE



C/108 VERDE



C/106 ROSA



C/105 ROSSO



C/112 BORDEAUX

65% Poliestere
35% Cotone

**RIF. 773G00 PANTALONI ELASTICO
E TASCHE**
Unisex
XS-YL
Serge 200 g/m²
Regular fit



**RIF. 772G00 PANTALONI
BIANCHI ELASTICO E TASCHE**
Unisex
XSS-YL
Serge 200 g/m²
Regular fit

RIF. 7733G0
PANTALONI ELASTICO
E TASCHE
Unisex
XS-YL
Serge 200 g/m²
65%PES - 35%CO
Regular fit



C/141 CREMA



C/116 ARANCIONE



C/122 VANIGLIA



C/138 LAMPONE



C/123 LILLA



C/136 VIOLA



C/121 VERDE OLIVA



C/139 GRIGIO ANTRACITE



C/127 PISTACCHIO



C/119 MALVA



C/115 TURCHESE



C/125 FUCSIA



C/117 GRIGIO PERLA



C/001 NERO



C/107 CELESTE



C/103 BLU



C/104 NAVY



C/112 BORDEAUX



C/105 ROSSO



C/108 VERDE

65% Poliestere
35% Cotone

RIF. 773000 PANTALONI
ZIP E TASCHE
Unisex
XS-YL
Serge 200 g/m²
Regular fit



RIF. 772000 PANTALONI
BIANCHI ZIP E TASCHE
Unisex
XSS-YL
Serge 200 g/m²
Regular fit



C/115 TURCHESE



C/127 PISTACCHIO



C/124 MARRONE

**65% Poliestere
35% Cotone**

RIF. 773300 PANTALONI ZIP
E TASCHE
Unisex
XS-YL
Serge 200 g/m²
Regular fit



RIF. 700900
Unisex
XS-YL
Serge 210 g/m²
Regular fit
100% Cotone

C/5119 VERDURE



C/123 LILLA



C/119 MALVA



C/125 FUCSIA



C/5107 LEGNI



C/5108 CATRINA

www.garysworkwear.com



RIF. 777200
Unisex. Taglie 36-58
Serge 195 g/m²
65%PES - 35%CO
c/725 Righe pistacchio
Regular fit



RIF. 777200
Unisex. Taglie 36-58
Serge 195 g/m²
65%PES - 35%CO
c/738 Righe grigie
Regular fit



RIF. 777200
Unisex. Taglie 36-58
Navetta 160 g/m²
65%PES - 35%CO
c/776 Quadri neri-grigi
Regular fit



RIF. 777200
Unisex. Taglie 36-58
Popeline 116 g/m²
65%PES - 35%CO
c/775 Principe di Galles
Regular fit



RIF. 777200
Unisex. Taglie 36-58
Navetta 160 g/m²
50%PES - 50%CO
c/749 Righe grigie
Regular fit



RIF. 770000
Unisex. Taglie 36-64
Vichy 118 g/m²
65%PES - 35%CO
c/211 Millierighe
Regular fit



RIF. 777100
Unisex. Taglie 36-64
Serge 195 g/m²
65%PES - 35%CO
c/706 Righe nere
Regular fit



RIF. 771000/771L00
Unisex. Taglie 36-64/XSS-YL
Vichy 118 g/m²
65%PES - 35%CO
c/202 Quadretti navy
Regular fit



RIF. 776000
Unisex. Taglie 36-64
Vichy 145 g/m²
50%PES - 50%CO
c/215 Pied-de-poule
Regular fit



RIF. 775000
Unisex. Taglie 36-64
Vichy 130 g/m²
50%PES - 50%CO
c/202 Quadretti navy
Regular fit



RIF. 702300
 Unisex. Taglie XS-YL
 Chambray rombi 120 g/m²
 70%CO - 30%PES
 c/1131 Grigio antracite
Regular fit



RIF. 701300
 Unisex. Taglie XS-YL
 Vichy bambola 165 g/m²
 65%CO - 35%PES
 c/266 Quadretti neri
Regular fit



RIF. 700700
 Unisex. Taglie XS-YL
 Popeline 116 g/m²
 65%PES - 35%CO
 c/753 Grigio antracite
Regular fit



RIF. 700700
 Unisex. Taglie XS-YL
 Popeline 116 g/m²
 65%PES - 35%CO
 c/001 Nero
Regular fit



RIF. 7017000
 Unisex. Taglie XS-YL
 Serge a righe 160 g/m²
 100%CO
 c/778 Righe fini bianche
Regular fit



RIF. 701500
 Unisex. Taglie XS-YL
 Jeans délavé 200 g/m²
 100%CO
 c/805 Jeans délavé
Regular fit



RIF. 777500
 Unisex. Taglie XS-YL
 Jeans 160 g/m²
 98%CO - 2%EA
 c/834 Zaffiro
Skinny fit

Settore alberghiero

RIF. 993300
Donna
Navetta 200 g/m²
50%PES 50%VI
XS-YL
c/801 Riga campera

RIF. 993100
Uomo
Navetta 200 g/m²
50%PES 50%VI
XS-YL
c/801 Riga campera



RIF. 963300
Uomo
Stretch 165 g/m²
100%PES
XS-YL
c/001 Nero

RIF. 963200
Donna
Stretch 165 g/m²
100%PES
XS-YL
c/001 Nero



Gilet di jeans



RIF. 994800 Fiego
Uomo
Jeans elasticizzati 260 g/m²
65%PES 32%CO 3%EA
XS-YL
c/826 Navy

RIF. 994700 Baena
Donna
Jeans elasticizzati 260 g/m²
65%PES 32%CO 3%EA
XS-YL
c/826 Navy





c/001 Nero

c/608 Grigio antracite

RIF. 994600
Uomo
Serge 220 g/m²
100%PES
XS-YL

RIF. 993400
Donna
Serge 220 g/m²
100%PES
XS-YL



RIF. 620100 M. Corta
Donna
Serge 200 g/m²
65%PES 35%CO
XS-YL
c/101 Bianco

RIF. 620200 M. lunga
Donna
Serge 200 g/m²
65%PES 35%CO
XS-YL
c/101 Bianco

RIF. 953000 M. lunga
Uomo
Serge 200 g/m²
65%PES 35%CO
XS-YL
c/101 Bianco



RIF. 963500
Donna
Stretch 165 g/m²
100%PES
XS-YL
c/625 Gessato

RIF. 963400
Uomo
Stretch 165 g/m²
100%PES
XS-YL
c/625 Gessato



RIF. 620700
Donna
Stretch 165 g/m²
100%PES
XS-YL
c/0112 Nero/Bordeaux

RIF. 963000
Uomo
Stretch 165 g/m²
100%PES
XS-YL
c/0112 Nero/Bordeaux

RIF. 961000
Uomo
Serge 200 g/m²
65%PES 35%CO
XS-YL
c/001 Nero

RIF. 960000
Uomo
Serge 200 g/m²
65%PES 35%CO
XS-YL
c/101 Bianco





c/101 Bianco



c/001 Nero

RIF. 965000
Uomo
Serge 200 g/m²
65%PES 35%CO
XS-YL

RIF. 998000
Donna
Serge 220 g/m²
100%PES
XS-YL
c/001 Nero



RIF. 997000
Uomo
Serge 220 g/m²
100%PES
XS-YL
c/001 Nero



RIF. 990000
Uomo
Serge 220 g/m²
100%PES
XS-YL
c/001 Nero



RIF. 963700 Agar
Donna
Serge 220 g/m²
100%PES
XS-YL

RIF. 963600 Arcas
Uomo
Serge 220 g/m²
100%PES
XS-YL

c/608 Grigio antracite

c/001 Nero



Polo

RIF. 851100
Uomo
Piqué 210 g/m²
50%PES 50%CO
XS-YL

RIF. 851500
Donna
Piqué 210 g/m²
50%PES 50%CO
XS-YL

c/776



c/775



gary's
RED LINE



COOLMAX

RIF. 852700 Colletto Uomo
Piqué 170 g/m²
100%PES
XS-YL
c/101 Bianco
c/001 Nero

RIF. 852600 Collo alla coreana
Uomo
Piqué 170 g/m²
100%PES
XS-YL
c/101 Bianco
c/001 Nero



RIF. 852900 Colletto Donna
Piqué 170 g/m²
100%PES
XS-YL
c/101 Bianco
c/001 Nero

RIF. 853100 Collo alla coreana
Donna
Piqué 170 g/m²
100%PES
XS-YL
c/101 Bianco
c/001 Nero

COOLMAX



gary's
RED LINE

c/104 Navy

c/112 Bordeaux

RIF. 100800
Unisex
Trama da 10 a 2 fili 2/42
100% Acrilico
Taglie 38-64

Sviluppo e creazione di ogni tipo di capo in maglia.
Scegli il modello, la combinazione e il colore.

Maglia

Caratteristiche della maglia:

Durata
Conservazione
Resistenza
Comodità
Meno cura dei capi

RIF. 102600
Uomo
Trama da 10 a 2 fili 2/42
70% Dralon acrilico 30% Lana Merino
Taglie 46-60

RIF. 102500
Donna
Trama da 10 a 2 fili 2/42
70% Dralon acrilico 30% Lana Merino
Taglie 38-52

c/139 Grigio antracite

c/104 Navy

c/001 Nero

RIF. 102200
Uomo
Trama da 10 a 2 fili 2/42
70% Dralon Acrilico
30% Lana merino
Taglie 46-60

RIF. 102100
Donna
Trama da 10 a 2 fili 2/42
70% Dralon Acrilico
30% Lana merino
Taglie 38-52

c/139 Grigio antracite

c/001 Nero

c/104 Navy



RIF. 102300
Uomo
Trama da 10 a 2 fili 2/42
70% Dralon acrilico 30% Lana Merino
Taglie 46-60

RIF. 102400
Donna
Trama da 10 a 2 fili 2/42
70% Dralon acrilico 30% Lana Merino
Taglie 38-52

RIF. 100900
Unisex
Trama da 10 a 2 fili 2/42
100% Acrilico
Taglie 38-64

c/104 Navy



c/112 Bordeaux

RIF. 103300
Donna
Trama da 12 a 1 filo 2/28
70% Dralon Acrilico
30% Poliammide
Taglie 38-52

c/001 Nero



c/104 Navy



c/104 Navy

c/001 Nero

RIF. 102900
Donna
Trama da 8 a 2 fili 2/22
100% Acrilico
Taglie 38-52

RIF. 102800
Uomo
Trama da 8 a 2 fili 2/22
100% Acrilico
Taglie 46-60



c/104 Navy

c/001 Nero

**Giacche a maglia
spessa.**

RIF. 103100
Donna
Trama da 10 a 2 fili 2/42
70% Dralon Acrilico
30% Lana merino
Taglie 38-52



c/104 Navy



c/001 Nero

RIF. 103200
Uomo
Trama da 10 a 2 fili 2/42
70% Dralon Acrilico
30% Lana merino
Taglie 46-60



c/104 Navy

c/001 Nero



RIF. 791500 CHINO
Uomo. Senza pence
Taglie 36-60
Tessuto Cold 205 g/m²
97%CO - 3%EA
Regular fit

RIF. 777800 CHINO
Uomo. Senza pence
Taglie 36-60
Serge smerigliato 270 g/m²
97%CO - 3%EA
Regular fit

Pantaloni per il settore alber- ghiero

garysworkwear.com



C/001 NERO



C/104 NAVY



C/139 GRIGIO ANTRACITE



C/129 OSSO



C/149 VERDE CACHI



C/109 GRIGIO



RIF. 205400 CHINO
Donna. Vita bassa
Taglie 36-58
Tessuto Cold 205 g/m²
97%CO - 3%EA

Slim fit

RIF. 204700 CHINO
Donna. Vita bassa
Taglie 36-58
Serge smerigliato 270 g/m²
97%CO - 3%EA

Slim fit



C/001 NERO



C/104 NAVY



C/139 GRIGIO ANTRACITE



C/129 OSSO



C/149 VERDE CACHI



C/109 GRIGIO



C/001 NERO



C/104 NAVY



C/624 MARRONE



C/139 GRIGIO ANTRACITE

RIF. 777700
 Uomo. Senza pence
 Taglie 36-60
 Stretch 165 g/m²
 100%PES
Regular fit



C/001 NERO



C/104 NAVY

RIF. 778600
 Uomo. Con pence
 Taglie 36-60
 Stretch 165 g/m²
 100%PES
Regular fit

Caratteristiche del lino

- Facile da lavare/Asciugatura rapida
- Resistente allo stretching
- Resistente all'abrasione
- Molto durevole
- Resistente alle macchie
- Traspirante
- Leggero
- Antibatterico
- Assorbe l'umidità
- Ipoallergenico

RIF. 701800
 Unisex
 XS-XL
 Navetta 165 g/m²
 50% Lino - 50% Cotone
Straight leg



C/101 BIANCO





RIF. 203400
Donna. Vita media
Taglie 36-60
Microfibra 125 g/m²
100%PES
Regular fit



C/001 NERO

RIF. 777900
Uomo senza pence
Taglie 36-60
Microfibra 125 g/m²
100%PES
Regular fit



C/001 NERO

RIF. 206300
Donna. Vita media
Taglie 36-58
Microfibra Elastik 155 g/m²
99%PES 1%EA
Regular fit



C/101 BIANCO



C/001 NERO



C/153 BLU PETROLIO



C/109 GRIGIO



C/156 CENERE

RIF. 791600
Uomo. Senza pence
Taglie 36-60
Serge 175 g/m²
55%CO 42%PES 3%EA
Slim fit



C/153 BLU PETROLIO



C/109 GRIGIO



C/156 CENERE

RIF. 206100
Donna. Vita media
Taglie 36-58
Serge 175 g/m²
55%CO 42%PES 3%EA
Slim fit



C/103 BLU



C/001 NERO



C/154 VERDE MUSCHIO

RIF. 791700

Uomo. Senza pence
Taglie 36-60
Occhio di pernice 255 g/m²
63%CO 35%PES 2%EA
Slim fit



C/103 BLU



C/001 NERO



C/154 VERDE MUSCHIO

RIF. 206200

Donna. Vita media
Taglie 36-58
Occhio di pernice 255 g/m²
63%CO 35%PES 2%EA
Slim fit





C/001 NERO



C/104 NAVY



C/139 GRIGIO ANTRACITE

RIF. 203500
Donna. Vita bassa
Taglie 36-56
Tecno 215 g/m²
96%PES 4%EA
Regular fit



C/001 NERO



C/104 NAVY

RIF. 203200
Donna. Vita alta
Taglie 36-58
Stretch 165 g/m²
100%PES
Regular fit





gary's *Sastrería*

Consulta più pantaloni
sul nostro catalogo
Gary's Sastrería.



C/001 NERO



C/104 NAVY

RIF. 202300
Donna. Vita bassa
Taglie 36-56
Tecno 215 g/m²
96%PES 4%CO
Slim fit



C/001 NERO



C/104 NAVY

RIF. 203600
Donna. Vita media
Taglie 36-56
Stretch 165 g/m²
100%PES
Slim fit

Gonne e bermuda



C/101 BIANCO



C/104 NAVY

RIF. 778500
Uomo
Taglie XS-YL
Bianco serge 200 g/m²
65%PES - 35%CO
Navy stretch 165 g/m²
100%PES



C/101 BIANCO



C/104 NAVY

RIF. 204500
Donna
Taglie XS-YL
Bianco serge 200 g/m²
65%PES - 35%CO
Navy stretch 165 g/m²
100%PES

RIF. 177400 GONNA PANTALONE
Donna
Taglie 36-58
Microfibra 148 g/m²
100%PES



C/104 NAVY



C/001 NERO



C/101 BIANCO



C/001 NERO



C/104 NAVY

RIF. 113F00
Donna. Apertura posteriore
Taglie 36-58
Stretch 165 g/m²
100%PES



C/001 NERO



C/104 NAVY

RIF. 176000
Donna. Apertura laterale
Taglie 36-58
Stretch 165 g/m²
100%PES



C/001 NERO



C/104 NAVY



C/139 GRIGIO ANTRACITE

RIF. 176800
Donna. Apertura posteriore
Taglie 36-58
Tecno 215 g/m²
96%PES - 4%EA



Grembiuli e casacche





RIF. 157800
Unisex con tasche
Taglia unica. 58x68 cm.
Tela 290 g/m²
85%CO 15%PES
c/148 Indaco

RIF. 157600
Unisex con tasca
Taglia unica. 87x73 cm.
Tela 290 g/m²
85%CO 15%PES
c/148 Indaco



RIF. 157700
Unisex con tasca
Taglie P-M-G
Tela 290 g/m²
85%CO 15%PES
c/148 Indaco



RIF. 158500
Unisex con tasca
Taglia unica. 91x108 cm.
Tela 290 g/m²
85%CO 15%PES
c/148 Indaco



gary's WORKWEAR

RIF. 158400
Unisex con tasche
Taglia unica. 86x77 cm.
Tela 290 g/m²
85%CO 15%PES
c/148 Indaco



Summer_ time

RIF. 158800
Unisex con tasche
Taglia unica. 50x68 cm.
Serge rustico 205 g/m²
50%PES 50%CO

c/124 Marrone

c/112 Bordeaux

c/104 Navy

RIF. 158700
Unisex con tasche
Taglia unica. 87x74 cm.
Serge rustico 205 g/m²
50%PES 50%CO

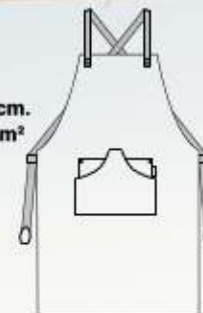

c/112 Bordeaux

c/124 Marrone

c/104 Navy

RIF. 157500
Unisex con tasche
Taglia unica. 45x68 cm.
Tela 290 g/m²
85%CO 15%PES



c/112 Bordeaux

c/104 Navy





c/112 Bordeaux

c/104 Navy

RIF. 157300

Unisex con tasche.

Taglia unica. 76x68 cm.

Tela 290 g/m²

85%CO 15%PES

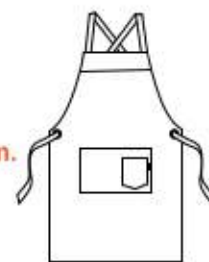

100%
Cotone.



c/5108 Catrina



c/5119 Verdure



RIF. 161100
Unisex con tasca
Taglia unica. 95x75 cm.
Serge 210 g/m²
100%CO

c/5103 Mimetico



c/5101 Olive

c/5102 Peperoncini

c/5107 Legni



c/151 Cammello

c/142 Sabbia

c/114 Avorio

c/147 Cioccolato

c/001 Nero

RIF. 330600 LACCIO DI CUIOIO
70 cm

Abbina il tuo grembiule.

a lacci di cuoio coordinati

RIF. 156400
Unisex con tasca
Taglia unica. 72x80 cm.
Serge 240 g/m²
65%PES 35%CO

Ogni grembiule comprende il suo laccio in pelle nelle seguenti combinazioni:

- GREMBIULE NERO - LACCIO NERO
- GREMBIULE CAMMELLO - LACCIO CIOCCOLATO
- GREMBIULE V. CACHI - LACCIO CAMMELLO
- GREMBIULE V. MUSCHIO - LACCIO CIOCCOLATO
- GREMBIULE B. PETROLIO - LACCIO CAMMELLO
- GREMBIULE CIOCCOLATO - LACCIO SABBIA.

c/001 Nero



garysworkwear.com



c/154 Verde muschio



c/153 Blu petrolio



c/147 Cioccolato



c/151 Cammello



c/149 Verde cachi



RIF. 149100
Unisex con tasca
Taglia unica.
35x57 cm.
Serge 200 g/m²
65%PES 35%CO
c/152 Blu grigiastro



c/5139 Verdure

Pack da 3.

RIF. 310100
Pack 3 canovacci da cucina
Serge 210 g/m²
100%CO



c/5109 Menu



RIF. 156600
Unisex con tasche
Taglia unica. 80x68 cm.
Serge 240 g/m²
65%PES 35%CO
c/149 Verde cachi

RIF. 156100
Unisex con tasca
Taglia unica. 85x80 cm.
Serge 200 g/m²
65%PES 35%CO
c/152 Blu grigiastro

gary's WORKWEAR

RIF. 156700
Unisex con tasche
Taglia unica. 86x91 cm.
Serge 240 g/m²
65%PES 35%CO

c/153 Blu petrolio

c/149 Verde cachi

c/001 Nero

Grembiuli stampati.

100% Poliestere



C/608 Grigio antracite



C/616 Rosso



C/607 Granata



C/604 Senape



C/614 Pistacchio



C/613 Turchese

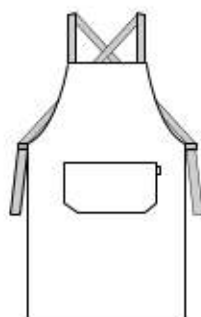

RIF. 158100 Gourmet
Unisex con tasca
Taglia unica. 92x75 cm.
Serge 220 g/m²
100%PES





C/5121 Kitchen



C/5128 Lollipop



C/5124 Wine



C/5122 Polaroid



C/5123 Bottiglia
vetro



C/5125 Tropicale



C/4112 Tattoo

RIF. 159200
Unisex con tasca
Taglia unica, 80x68 cm.
Serge 220 g/m²
100%PES

Grembiule bistrot.

RIF. 182200

Unisex con tasche
Taglia unica. 80x65 cm.
Serge 220 g/m²
100%PES



C/001 C/608 C/618 C/607 C/616 C/615



C/617 C/613 C/609 C/612 C/611 C/614



RIF. 182000
 Unisex con tasche
 Taglia unica. 80x65 cm.
 Serge 200 g/m²
 65%PES 35%CO



C/101 C/117 C/139 C/001 C/104 C/103 C/107



C/115 C/108 C/118 C/121 C/127 C/111 C/116 C/105



C/112 C/123 C/119 C/138 C/125 C/136 C/141 C/124



RIF. 182V00
 Unisex con tasche
 Taglia unica. 80x65 cm.
 Jeans 260 g/m²
 65%PES 35%CO 3%EA
 C/804



RIF. 183000

Unisex con tasca
Taglia unica: 80x65 cm.
Serge 200 g/m²
65%PES 35%CO



C/112
BORDEAUX

C/127
PISTACCHIO

C/115
TURCHESE

C/125
FUCSIA

C/138
LAMPONE

C/117
GRIGIO
PERLA



Rif. 127000

Unisex senza tasca
Taglia unica. 95x75 cm.
Navetta 265 g/m²
70%PES 30%PAC



C/108 VERDE

C/110 BEIGE

C/105 ROSSO

Grembiule



C/101 C/112 C/001 C/104 C/103 C/108 C/111 C/105

RIF. 118000
Unisex senza tasca
Taglia unica. 90x75 cm.
Serge 200 g/m²
65%PES 35%CO

fran- cese



C/101 C/112 C/001

RIF. 118G00
Unisex senza tasca.
Taglia unica. 100x100 cm.
Serge 200 g/m²
65%PES 35%CO

Senza tasca.



Con tasca.



RIF. 118B00
Unisex con tasca
Taglia unica. 90x75 cm.
Serge 200 g/m²
65%PES 35%CO



RIF. 118GB0
Unisex con tasca.
Taglia unica. 100x100 cm.
Serge 200 g/m²
65%PES 35%CO





Con apertura.

RIF. 191000
Unisex con tasca.
Taglia unica. 90x110 cm.
Serge 200 g/m²
65%PES 35%CO



C/101 C/117 C/139 C/001 C/104 C/103 C/115 C/107 C/108 C/118 C/121 C/127



C/111 C/116 C/105 C/112 C/125 C/138 C/136 C/119 C/123 C/122 C/141 C/124



C/617

C/607

C/618

C/001

C/608

Serge 100% Poliestere



RIF. 191200

Unisex con tasca
Taglia unica. 90x110 cm.
Serge 220 g/m²
100%PES



Vasta gamma di colori.

65% Poliestere
35% Cotone

RIF. 120000
Unisex con tasca
Taglia unica. 30x60 cm.
Serge 200 g/m²
65%PES 35%CO



Serge 100% Poliestere

RIF. 120600
Unisex con tasca
Taglia unica, 30x60 cm.
Serge 220 g/m²
100%PES





65% Poliestere 35% Cotone

RIF. 116BC0
Unisex con tasca
Taglia unica. 90x75 cm.
Serge 200 g/m²
65%PES 35%CO



C/141 C/122 C/111 C/116 C/105 C/112 C/125



C/138 C/119 C/123 C136 C/104 C/103 C/107 C/115



C/101



C/108 C/127 C/121 C/118 C/124 C/001 C/139 C/117

Con tasca.

Serge 100% Poliestere

RIF. 116100
Unisex con tasca
Taglia unica. 90x75 cm.
Serge 220 g/m²
100%PES



C/615 C/616 C/607 C/611 C/612 C/609 C/617 C/613 C/614 C/618 C/608 C/001



65% Poliestere
35% Cotone

RIF. 116000
Unisex con tasca
Taglia unica. 90x75 cm.
Serge 200 g/m²
65%PES 35%CO



Senza tasca.





C/112

C/001

C/101



C/112

C/001

C/101



65% Poliestere
35% Cotone

Con laccio in cotone

RIF. 116300 Unisex senza tasca

RIF. 116400 Unisex con tasca

Taglia unica. 90x75 cm.

Serge 200 g/m²

65%PES 35%CO

**Grembiule
economico.**



C/5138 Country

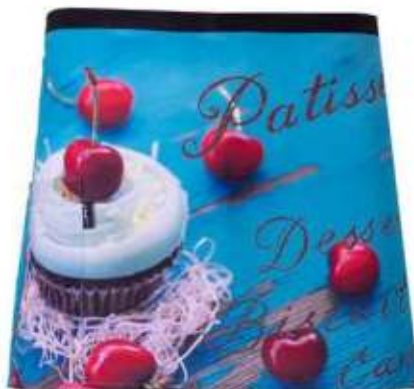

C/5137 Biscuit



C/5136 Coffee

RIF. 159100

Unisex con tasca
Taglia unica. 35x60 cm.
Serge 220 g/m²
100%PES

RIF. 159300

Unisex con tasca
Taglia unica. 47x74 cm.
Serge 220 g/m²
100%PES



C/5124 Wine



C/5123 Bottiglia
vetro



C/5135 Lavagna



Grembiuli corti colori divertenti

65% Poliestere - 35% Cotone



RIF. 117B00 BLANCO
Unisex con tasca
Taglia unica. 50x75 cm.
Serge 200 g/m²
65%PES 35%CO

RIF. 11745B COLORE
Unisex con tasca
Taglia unica. 50x75 cm.
Serge 200 g/m²
65%PES 35%CO

C/117 C/139 C/001 C/123 C/119 C/138 C/125 C/105 C/112 C/116 C/111



C/127 C/121 C/108 C/118 C/122 C/141 C/124 C/136 C/107 C/115 C/103 C/104





Con tasca.

RIF. 117100
Unisex con tasca
Taglia unica. 50x75 cm.
Serge 220 g/m²
100%PES

Serge 100% Poliestere

C/608 C/001 C/612 C/611 C/616 C/607



C/615 C/614 C/618 C/609 C/613 C/617



65% Poliestere
35% Cotone

RIF. 117000
Unisex senza tasca
Taglia unica. 50x75 cm.
Serge 200 g/m²
65%PES 35%CO

Senza tasca.



Grembiule
economico.

RIF. 120300

Unisex con tasca e lacci di cotone.

Taglia unica. 30x60 cm.

Serge 200 g/m²

65%PES 35%CO



C/112

C/101

C/001

MAXI
RESTAURANTE

RIF. 180000

Unisex con tasche
Taglia unica. 110x85 cm.
Serge 200 g/m²
100%PES



C/607

C/001

C/606



C/001

C/607

C/608

C/606

RIF. 181000

Unisex con tasca
Taglia unica. 68x68 cm.
Serge 200 g/m²
100%PES



C/001

RIF. 156300

Unisex con tasca

Finiture satinare

Taglia unica

Serge 300 g/m²

50%PES 50%CO



c/625 Gessato

c/608 Grigio antracite

RIF. 184100

Unisex con tasca
Taglia unica. 82x77 cm.
Serge 220 g/m²
100%PES



Delantal tejano.

RIF. 191100
Unisex con tasche
Taglia unica. 90x105 cm.
Jeans délavé 275 g/m²
100%CO

c/805 Jeans délavé

RIF. 153300
Unisex con tasche
Taglia unica. 95x75 cm.
Jeans délavé 275 g/m²
100%CO

c/805 Jeans délavé



RIF. 153700

Unisex con tasca
Taglia unica. 95x75 cm.
Jeans senza lavaggio 275 g/m²
100%CO



c/805 Jeans senza lavaggio

gary's WORKWEAR



c/804

c/706

c/705

c/001

RIF. 161000
Unisex con tasca
Taglia unica. 95x75 cm.
Serge 200 g/m²
65%PES 35%CO



RIF. 123100
Unisex con tasca
Taglia unica. 30x60 cm.
Serge 200 g/m²
65%PES 35%CO

c/775



c/776



RIF. 123000
GREMBIULE RIGIDO
Unisex. Taglia unica.
110x85 cm.
Cordino regolabile
PVC 100%



RIF. 115000
GREMB. RICCIO

RIF. 115A0
GREMB. RICCIO
ALTA TEMPERATURA

Taglia unica.
90x75 cm.
Riccio/PVC





RIF. 486000
MANICOTTO POLIPROPILENE
PACK DA 2
Taglia unica. Lunghezza 45 cm.
65% Polipropilene
290 g/m²

RIF. 125000
GREMBIULE TELA CERATA
Unisex
Taglia unica. 90x70 cm.
100% Polipropilene
290 g/m²



RIF. 486200
MANICOTTO SERGE
PACK DA 2
Taglia unica. Lunghezza 45 cm.
65% PES 35% CO
200 g/m²

RIF. 126100
GREMBIULE NITRILE
Unisex. Taglia unica.
115x90 cm. Bretelle regolabili.
Nitrile
600 g/m²

Caratteristiche del nitrile:

- Elevata resistenza ai grassi animali, al sangue e alle alte temperature.
- Maggiore durabilità.
- Maggiore flessibilità.



Caratteristiche del vinile:

- Protezione di base contro l'acqua.
- Ideale per hotel, ristoranti e servizi pubblici.

RIF. 124000 SKAY
Unisex senza tasca
Taglia unica. 90x70 cm.
80%PVC - 20%CO
550 g/m²



RIF. 126300 VNILO
Unisex con tasca
Taglia unica. 115x90 cm.
475 g/m²





RIF. 126200 ELASTÓMERO
Unisex senza tasca
Taglia unica. 115x85 cm.
450 g/m²

Caratteristiche dell'elastomero:

- Resistenza ai grassi animali, al sangue e ai normali prodotti di pulizia.
- Alta flessibilità.
- Gradevole da indossare.
- Facile da pulire.



RIF. 126500 PETER
Unisex. Taglia unica.
90x135 cm.
100% Poliuretano
230 g/m²

Colori disponibili:



Caratteristiche del poliuretano:

- Alta resistenza ai grassi animali e al sangue.
- Protegge contro i rischi meccanici.
- Elevata resistenza alla penetrazione dell'acqua.

gary's WORKWEAR



Colori disponibili:

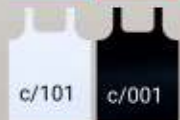

RIF. 126400 ANDREW
Unisex. Taglia unica.
115x90 cm.
100% Poliuretano
355 g/m²

Imbracatura regolabile e occhielli termosigillati, non metallici.





RIF. 111000
Donna
Taglia unica. 80x54cm.
Serge 200 g/m²
65%PES 35%CO

RIF. 107000
Donna
Taglia unica. 80x54cm.
Serge 200 g/m²
65%PES 35%CO



RIF. 108000
Donna
Taglia unica. 80x54cm.
Serge 200 g/m²
65%PES 35%CO



RIF. 108000 VICHY
Donna
Taglia unica. 80x54cm.
Vichy 118 g/m²
65%PES 35%CO

RIF. 212500
Donna
Taglia unica
Serge 200 g/m²
65%PES 35%CO



C/138 Lampone

C/127 Pistacchio



C/117 Grigio perla

C/115 Turchese

Casullas



C/124 Marrone



RIF. 212600
Donna
Taglia unica
Serge 200 g/m²
65%PES 35%CO

C/139 Grigio antracite



RIF. 202000
 Donna
 Taglia unica. 85x51cm.
 Serge 200 g/m²
 65%PES 35%CO



C/105 C/112 C/116 C/111 C/122 C/141 C/124 C/001 C/139 C/117



C/121 C/127 C/108 C/118 C/104 C/103 C/115 C/107 C/123 C/136



C/202 C/203 C/204 C/205 C/206 C/207 C/208 C/209 C/212

RIF. 202000
 Donna
 Taglia unica. 85x51cm.
 Vichy 118 g/m²
 65%PES 35%CO



C/612 C/611 C/616 C/607 C/615 C/618



C/614 C/613 C/609 C/617 C/001 C/608



Serge 100% Poliestere

RIF. 202200
Donna
Taglia unica. 85x51cm.
Serge 220 g/m²
100%PES

Piccoli cuochi,



RIF. 111600 GREMBIULE BIANCO
RIF. 111800 GREMBIULE COLORATO
Taglie 4-8-12
Serge 200 g/m²
65%PES 35%CO

RIF. 445100 CAPPELLO DA CHEF BIANCO
RIF. 445300 CAPPELLO DA CHEF COLORATO
Taglie 6 e 12
Serge 200 g/m²
65%PES 35%CO

C/138 Lampone



Misure: lunghezza x larghezza
T4 = 50x40 cm.
T8 = 65x50 cm.
T12 = 80x60 cm.

C/127 Pistacchio



C/116 Arancione



C/115 Turchese



C/101 Bianco

Grandi chef.

RIF. 950100 GIACCA BIANCA
RIF. 950200 GIACCA COLORATA
Taglie 4-6-8-10-12-14
Serge 200 g/m²
65%PES 35%CO

Misure lunghezza
T4 = 47 cm.
T14 = 70 cm.



C/115 Turchese



C/116 Arancione



C/127 Pistacchio



C/138 Lampone



C/101 Bianco

POCOYO™

by **gary's**

RIF. 111900 GREMBIULE POCOYO AMICI

Taglie 4-8
Serge 220 g/m²
100%PES
C/101 Bianco

RIF. 445200 CAPPELLO DA CHEF POCOYO

Taglia 6
Serge 220 g/m²
100%PES
C/101 Bianco





aecc
Contra el Càncer

*Il 50% dei proventi verrà destinato
all'Associazione spagnola contro il cancro.*



RIF. 212300 CASACCA AECC HOPE
Donna
Taglia unica
Stretch 165 g/m²
100%PES
C/888



RIF. 159700 GREMBIULE AECC HOPE
Unisex con tasca
Taglia unica
Stretch 165 g/m²
100%PES
C/888



RIF. 614800 BLUSA AECC HOPE
Unisex
XSS-YL
Microfibra 148 g/m²
100%PES
C/888



RIF. 370100 BORSA AECC HOPE

Taglia unica

Stretch 165 g/m²

100%PES

C/888

A man and a woman are standing in front of a wall made of vertical bamboo poles. The man is on the left, wearing a light-colored jacket and dark pants, with his hand on his hip. The woman is on the right, wearing a matching light-colored jacket and dark pants, with her hands resting on the bamboo wall. The background shows lush greenery and a building with a tiled roof.

Per una moda più sostenibile.

La nostra linea ecologica utilizza tessuti sostenibili, tra cui cotone biologico e poliestere 100% riciclato.



gary's
naturewear

www.garysworkwear.com/naturewear

RIF. 450200 CAPPELLO GRAN CHEF
Unisex
Serge 205 g/m²
100% POLIESTERE RICICLATO
Taglia unica
c/5134 Planet

RIF. 441600 CAPPELLO PIRATA
Unisex
Microfibra 145 g/m²
100% POLIESTERE RICICLATO
Taglia unica
c/5134 Planet

RIF. 942700 GIACCA CUCINA PLANET
Unisex
Microfibra 145 g/m²
100% POLIESTERE RICICLATO
XS-YL
c/5134 Planet



aerosilver

RIF. 703500 PANTALONI
Unisex
Microfibra 145 g/m²
100% POLIESTERE RICICLATO
XS-YL
c/5134 Planet



RIF. 943100 ARIAS
Unisex
Microfibra 145 g/m²
100% POLIESTERE RICICLATO
XS-YL
c/101 Bianco



 aerosilver



RIF. 441700 CAPPELLO PIRATA
Unisex
Microfibra 145 g/m²
100% POLIESTERE RICICLATO
Taglia unica



RIF. 703600 PANTALONI
Unisex
Microfibra 145 g/m²
100% POLIESTERE RICICLATO
XS-YL



c/101 Bianco



c/001 Nero

gary's

naturewear



GREENWEAR

RIF. 942600 GIACCA BELTRÁN
Unisex
Serge 180 g/m²
50% COTONE BIOLOGICO
50% POLIESTERE RICICLATO
XS-YL
c/117 Grigio perla



RECYCLED
POLYESTER

ORGANIC COTTON

aerosilver



c/142 Sabbia

RIF. 942500 GIACCA OTERO
Uomo
Serge 180 g/m²
50% POLIESTERE RICICLATO
50% COTONE BIOLOGICO
XS-YL

RIF. 942900 GIACCA ANAYA
Donna
Serge 180 g/m²
50% POLIESTERE RICICLATO
50% COTONE BIOLOGICO
XS-YL



GREENWEAR

c/117 Grigio perla



aerosilver



garys
naturewear



 aerosilver



 GREENWEAR

RIF. 942400 GIACCA HARO
Unisex
Serge 180 g/m²
50% POLIESTERE RICICLATO
50% COTONE BIOLOGICO
XS-YL
c/101 Bianco





C/142 Sabbia



C/117 Grigio perla



C/101 Bianco

RIF. 450100 CAPPELLO GRAN CHEF
Unisex
Serge 180 g/m²
50% POLIESTERE RICICLATO
50% COTONE BIOLOGICO
Taglia unica



C/142 Sabbia



C/117 Grigio perla



C/101 Bianco

RIF. 441500 CAPPELLO PIRATA
Unisex
Serge 180 g/m²
50% POLIESTERE RICICLATO
50% COTONE BIOLOGICO
Taglia unica



RIF. 703400 PANTALONI
Unisex
Serge 180 g/m²
50% POLIESTERE RICICLATO
50% COTONE BIOLOGICO
XS-YL



RIF. 963900 GIACCA PINEDA
Donna
Serge 160 g/m²
100% POLIESTERE RICICLATO
XS-YL

RIF. 963800 GIACCA DUARTE
Uomo
Serge 160 g/m²
100% POLIESTERE RICICLATO
XS-YL

RIF. 778900 PANTALONI
Uomo
Serge 160 g/m²
100% POLIESTERE RICICLATO
Taglie 36-60

RIF. 205900 PANTALONI
Donna
Serge 160 g/m²
100% POLIESTERE RICICLATO
Taglie 36-58



gary's
naturewear

RIF. 212400 CASACCA
Donna
Tela 211 g/m²
100% COTONE BIOLOGICO
Taglia unica
c/110 Beige





RIF. 206400 PANTALONI DONNA
RIF. 779500 PANTALONI UOMO
Taglie 36-60
Microfibra 125 g/m²
100% POLIESTERE RICICLATO
c/001 Nero



RECYCLED
POLYESTER

RIF. 243900 CAMICIA IDARA
Donna
XS-YL
Popeline 110 g/m²
65% POLIESTERE RICICLATO
35% COTONE
c/101 Bianco





RIF. 261100 CAMICIA ELISEO SLIM FIT
Uomo
Taglie 38-50
Popeline 110 g/m²
65% POLIESTERE RICICLATO
35% COTONE
c/101 Bianco



RIF. 449700 BERRETTO GATSBY
Unisex. Taglia unica
Tela beige 211 g/m²
Tela grigio antracite 250 g/m²
100% COTONE BIOLOGICO

c/110 Beige

c/139 grigio



ORGANIC COTTON

RIF. 157400 DELANTAL
Unisex con tasca.
Taglia unica. 76x92 cm.
Tela beige 211 g/m²
Tela grigio antracite 250 g/m²
100% COTONE BIOLOGICO

gary's
naturewear

RIF. 158600 GREMBIULE CON PETTORI-
NA

Unisex con tasche
Taglia unica. 91x74 cm.
Tela 310 g/m²

100% COTONE BIOLOGICO

RIF. 159500 GREMBIULE SENZA PETTO-
RINA

Unisex con tasche
Taglia unica. 46x68 cm.
Tela 310 g/m²

100% COTONE BIOLOGICO

c/114 Avorio



ORGANIC COTTON

RIF. 159600
Unisex con tasca
Taglia unica, 80x68 cm.
Serge 205 g/m²
100 % POLIESTERE RICICLATO



c/5132 Nature



c/5133 Breathe



c/5131 Preserve



c/5129 Life

garys
naturewear

RIF. 159800 GREMBIULE CON PETTORI-
NA
Unisex con tasca
Taglia unica. 91x74 cm.
Serge 205 g/m²
100% COTONE BIOLOGICO



c/109 Grigio

c/101 Bianco



c/156 Cenere

c/114 Avorio

c/152 Blu grigiastro

garys
naturewear

RIF. 159900 GREMBIULE SENZA PETTO-
RINA
Unisex con tasca
Taglia unica. 42x72 cm.
Serge 205 g/m²
100% COTONE BIOLOGICO



c/109 Grigio

c/101 Bianco



c/156 Cenere

c/114 Avorio

c/152 Blu grigiastro



Cappelli e accessori



C/4112 TATTOO



C/4115 MELANZANE



C/4114 MILITARE



C/4113 RAGNO GRIGIO



C/4116 COCO



C/4111 ARAZZO



C/5111 CARPE



C/4104 UOVA ALL'OCCHIO DI BUE



C/5112 GAMBERI



C/5113 ICONE



C/5114 SABOR



C/5127 CLEAVER



C/5115 EQUAZIONE



C/5116 FORNELLO



C/5121 KITCHEN



C/5117 FIAMME



C/5118 MEZCLUM

Cappello Gran Chef.

RIF. 448900

Unisex

Taglia unica. Regolabile con velcro

Serge 220 g/m²

100%PES



RIF. 449300

Unisex

Taglia unica. Regolabile con
velcro

Vichy bambola 165 g/m²

65%CO 35%PES

C/266 NERO



C/5107 LEGNI

RIF. 448800

Unisex

Taglia unica. Regolabile con velcro

Serge 210 g/m²

100%CO



C/5108 CATRINA



C/5102 PEPERONCINI



C/5101 OLIVE



C/5103 MIMETICO



C/5119 VERDURE



C/104 NAVY



C/112 BORDEAUX



C/001 NERO

gary's WORKWEAR

RIF. 448600 RIBETEADO

Unisex

Taglia unica. Regolabile con velcro

Serge 200 g/m²

65%PES 35%CO



C/136 VIOLA



C/123 LILLA



C/119 MALVA



C/125 FUCSIA



C/138 LAMPONE



C/124 MARRONE



C/112 BORDEAUX



C/105 ROSSO



C/116 ARANCIONE



C/121 VERDE OLIVA



C/118 VERDE BOTTIGLIA



C/127 PISTACCHIO



C/115 TURCHESE



C/103 BLU



C/104 NAVY



C/001 NERO



C/139 GRIGIO ANTRACITE



C/117 GRIGIO PERLA



C/141 CREMA



C/101 BIANCO

RIF. 4481V0 SARGA

Unisex

Taglia unica. Regolabile con velcro

Serge 200 g/m²

65%PES 35%CO

RIF. 445V00 SERGE BIANCO

Unisex

Taglia unica. Regolabile con velcro

Serge 200 g/m²

65%PES 35%CO



C/706 RIGHE NERE



C/776 QUADRI NERI/GRIGI



C/738 RIGHE GRIGIE



C/749 RIGHE GRIGIE SOTTILI



C/775 STAMPA PRINCIPE DI GALLES



C/804 JEANS



C/725 RIGHE PISTACCHIO

RIF. 4482V0
Unisex
Taglia unica. Regolabile con velcro
Tessuto in base al colore

gary's WORKWEAR



C/202 QUADRETTI NAVY

RIF. 447V00
Unisex
Taglia unica. Regolabile con velcro
Vichy 118 g/m²
65%PES 35%CO



C/101/202

RIF. 446V00
Unisex
Taglia unica. Regolabile con velcro
Serge 200 g/m²
65%PES 35%CO



C/805 JEANS DÉLAVÉ

RIF. 449200 TEJANO
Unisex
Taglia unica. Regolabile con velcro
Jeans délavé 200 g/m²
100%CO



C/4112 TATTOO



C/4113 RAGNO GRIGIO



C/4114 MILITARE



C/4115 MELANZANE



C/4116 COCO



C/5111 CARPE



C/5118 MEZCLUM



C/5116 FORNELLO



C/5112 GAMBERI



C/5117 FIAMME



C/5127 CLEAVER



C/5121 KITCHEN



C/5113 ICONE



C/5115 EQUAZIONE



C/5114 SABOR

Cappello pirata.

Microfibra stampata

RIF. 441200

Unisex

Taglia unica

Microfibra 148 g/m²

100%PES



C/1131 GRIGIO ANTRACITE

RIF. 441400
Unisex
Taglia unica
Chambray rombi 148 g/m²
70%CO 30%PES



C/5108 CATRINA



C/5101 OLIVE



C/5102 PEPERONCINI



C/5107 LEGNI



C/5119 VERDURE



C/5103 MIMETICO

RIF. 441100
Unisex
Taglia unica
Serge 210 g/m²
100%CO

100% Cotone



C/001 NERO



C/101 BIANCO



C/104 NAVY



C/105 ROSSO



C/107 CELESTE



C/108 VERDE



C/112 BORDEAUX



C/115 TURCHESE



C/119 MALVA



C/127 PISTACCHIO



C/138 LAMPONE



C/139 GRIGIO ANTRACITE



C/142 SABBIA

RIF. 441800

Unisex

Taglia unica

Microfibra 148 g/m²

100%PES

Tanti colori

nei cappelli in microfibra

Happier Workplaces





C/804 JEANS



C/775 STAMPA PRINCIPE DI GALLES



C/202 QUADRETTI NAVY



C/749 RIGHE GRIGIE SOTTILI



C/706 RIGHE NERE



C/738 RIGHE GRIGIE



C/725 RIGHE PISTACCHIO



C/101 BIANCO



C/117 GRIGIO PERLA



C/139 GRIGIO ANTRACITE



C/141 CREMA



C/124 MARRONE



C/001 NERO



C/112 BORDEAUX



C/105 ROSSO



C/136 VIOLA



C/123 LILLA



C/119 MALVA



C/138 LAMPONE



C/125 FUCCIA

RIF. 447100

Unisex

Taglia unica

Tessuto in base al colore



C/127 PISTACCHIO



C/103 BLU



C/121 VERDE OLIVA



C/104 NAVY



C/116 ARANCIONE



C/115 TURCHESE



RIF. 447900 AEROSILVER

Unisex

Taglia unica.

Aerosilver 140 g/m²

100%PES



RIF. 447800 TEJANO

Unisex

Taglia unica.

Jeans délavé 200 g/m²

100%CO



C/4112 TATTOO



C/4113 RAGNO GRIGIO



C/4114 MILITARE



C/4115 MELANZANE



C/4116 COCO



C/5111 CARPE



C/5118 MEZCLUM



C/5116 FORNELLO



C/5112 GAMBERI



C/5117 FIAMME



C/5127 CLEAVER



C/5121 KITCHEN



C/5113 ICONE



C/5115 EQUAZIONE



C/5114 SABOR



C/4104 UOVA ALL'OCCHIO DI BUE



C/4111 ARAZZO

Bandana aerosilver

RIF. 200100 BANDANA STAMPATA

Unisex

Taglia unica

Aerosilver 140 g/m²

100%PES



C/127



C/105



C/115



C/139



C/001



C/101



RIF. 200200 BANDANA TINTA UNITA
Unisex
Taglia unica
Aerosilver 140 g/m²
100%PES

aerosilver

RIF. 450300
Unisex
Taglie P e M
Popeline 116 g/m²
65%PES 35%CO

Chiusura con velcro.



RIF. 447500 SIROS
Unisex
Taglie M e G
Serge 200 g/m²
65%PES 35%CO

C/001



C/101



RIF. 448400
Unisex
Taglie 54-62
100% Nylon

C/001



C/101





C/115 TURCHESE



C/116 ARANCIONE



C/123 LILLA



C/119 MALVA



C/127 PISTACCHIO



C/108 VERDE



C/001 NERO



C/105 ROSSO



C/111 GIALLO



C/106 ROSA



C/112 BORDEAUX



C/107 CELESTE



C/103 BLU



C/104 NAVY



C/202 QUADRETTI NAVY



C/124 MARRONE



C/125 FUCSIA

Berretti

PACK DA 10 UNITÀ

RIF. 415000 RETE PACK 10

Unisex

Taglia unica

65%PES 35%CO



C/108 VERDE



C/115 TURCHESE



C/105 ROSSO



C/127 PISTACCHIO



C/104 NAVY



C/001 NERO



PACK DA 10 UNITÀ

RIF. 416000 RETE COLOR PACK 10

Unisex
Taglia unica
65%PES 35%CO



RIF. 420000 PACK 10

Unisex
Taglia unica
65%PES 35%CO
Popeline 116 g/m²

C/101 BIANCO



RIF. 421000 PACK 10

Unisex
Taglia unica
65%PES 35%CO
Popeline 116 g/m²

C/001 NERO



**RIF. 410000 PACK 10
RIF. 410100 MAXI PACK 10**

Unisex
Taglia unica
65%PES 35%CO

C/101 RETE BIANCO



C/101 BIANCO



C/001 NERO

RIF. 422000 PACK 10

Unisex
Taglia unica
65%PES 35%CO



C/ 101/105 ROSSO



C/ 101/112 BORDEAUX



C/101/104 NAVY



C/101/001 NERO

RIF. 440000 BORDATI PACK 6

Unisex
Taglie P-M-G-SG
65%PES 35%CO



C/103 BLU



C/001 NERO



C/108 VERDE



C/105 ROSSO



C/112 BORDEAUX

RIF. 435000 PACK 6

Unisex
Taglie P-M-G-SG
65%PES 35%CO



C/001 NERO



C/112 BORDEAUX

RIF. 449100 PACK 6 BORDATI

Unisex
Taglie P-M-G-SG
65%PES 35%CO



C/104 NAVY



C/101 BIANCO

RIF. 405100 PACK 10 COPRINUCA

Unisex
Taglia unica
65%PES 35%CO



C/101 BIANCO

RIF. 400000 PACK 6

Unisex
Taglie P-M-G-SG
65%PES 35%CO



C/101 BIANCO

RIF. 401000 PACK 6

Elastico posteriore
Unisex
Taglia unica
65%PES 35%CO



C/101 BIANCO

RIF. 446200 PACK 10 CAPPELLI RETE

Unisex
Taglia unica
100%PES



C/101 BIANCO

RIF. 405000 PACK 10

Unisex
Taglia unica
Elastico posteriore
65%PES 35%CO

RIF. 446100 PACK 6 A COSTE

Unisex
Taglia unica
100%PES



Complementi e accessori.



C/101



C/104

RIF. 120020 ZOCCOLI PELLE

Unisex
Taglie 36-45



C/104

C/001

C/112



RIF. 322000 CRAVATTA CON NODO

Unisex con clip
Taglia unica
Raso



C/127

C/118

C/103

C/136

C/104

C/138

C/116

C/105

C/112

C/110

C/124

C/117

C/139

C/001



RIF. 321000 CRAVATTA SENZA NODO

Unisex
Taglia unica
Raso

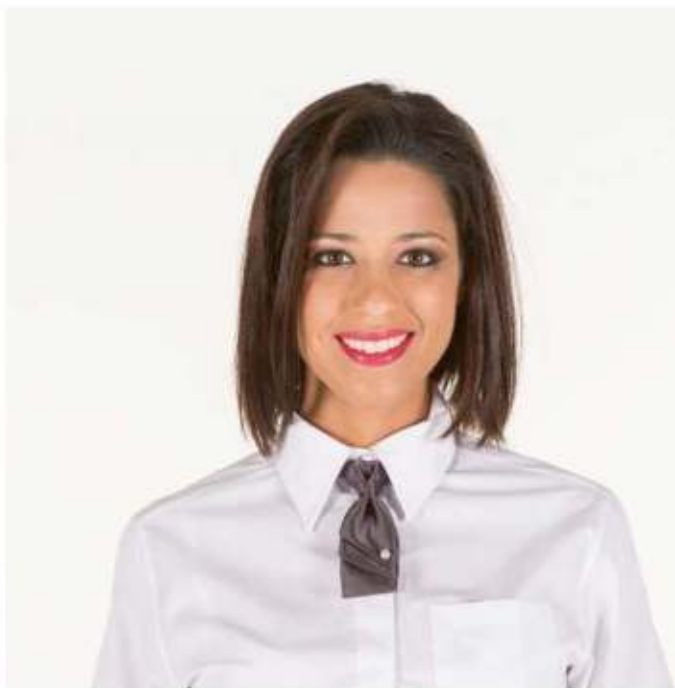

C/117
C/139
C/001
C/103
C/136
C/104
C/138
C/105
C/112
C/127
C/118
C/110
C/124
C/116



C/139
C/001
C/104
C/112



C/123
C/119
C/116
C/112
C/115
C/127
C/122
C/124
C/001



RIF. 324000 PAPILLON

Unisex
Taglia unica
Raso

RIF. 323000 CRAVATTINO

Unisex
Taglia unica
Raso

RIF. 325000 FIOCCO CON VELCRO

Unisex regolabile
Taglia unica
Serge
65% Poliestere - 35% Cotone



C/827



C/001

C/828

C/805

RIF. 350100 FONDINA PDA

Unisex
Taglia unica

RIF. 470000 TOVAGLILO PER CAMERIERE PACK 6

70x40 cm.
100% Cotone



C/107

C/108

C/111

C/104

C/101

C/112

C/001

C/103

C/105

gary's WORKWEAR

RIF. 460000 FAZZOLETTO COLORATO PACK 6

RIF. 450000 FAZZOLETTO BIANCO PACK 6

Unisex
Taglia unica. 67x67x97 cm.
Popeline
65% Poliestere - 35% Cotone

RIF. 329000 BRETELLA ELASTICA

Unisex
Taglia unica



Consulta altri modelli di bretelle e cravatte sul nostro catalogo:

gary's *Sastreria*



gary's WORKWEAR

T400 Technology

**ELASTICIDAD
COMODIDAD
RESISTENCIA.**



Humidity control

Chemical resist.

Durability

Elasticity

90°C washing

Comfort

Bottone metallico Gary's

Tasca nascosta

Rinforzo per cintura

Rinforzo cavallo

Vita elasticizzata

Striscia catarifrangente

Rinforzo posteriore

Rinforzo ginocchia

Tasca capiente



C/109 GRIGIO



C/104 NAVY



C/110 BEIGE

RIF. 750200 ARCE

Pantaloni unisex multitasca
Taglie 34-62

Tessuto elasticizzato T400 245 g/m²
68%PES 28%CO 4%EA



C/001 NERO



C/101 BIANCO





gary's WORKWEAR

T400 Technology

CARACTERÍSTICAS

- Resistente al lavaggio industriale a 90°.
- Elasticità permanente, la recupera sempre.
- Elevato livello di comfort con il mix tra tessuto e disegno del capo.
- Ottimo controllo dell'umidità.
- Eccellente resistenza agli elementi chimici.

garysworkwear.com



Scopri di più

Consulta il nostro catalogo Denim, Gastrochef, Sastrería, e Collezione Camicie, in cui potrai trovare una vasta collezione per l'alta cucina e per il settore alberghiero.

garysworkwear.com



gary's *Sastreria*

GASTROCHEF
by **garys**

DENIM
gary's

Collezione Camicie
Shirt Collection

Happier Workplaces

Hai un'idea?

Possiamo creare qualsiasi disegno. Stampe personalizzate, modelli su misura, personalizzazione di rifiniture, ricami o serigrafie. L'immaginazione non ha limiti e insieme possiamo realizzare la tua idea.

Specializzati nella personalizzazione di indumenti aziendali.

Il nostro team di modellisti e stilisti esperti è specializzato nello sviluppo di proposte mirate, che si adeguano al meglio alle tue necessità e alla tua immagine aziendale. Puntiamo sulla qualità dei tessuti e della confezione. Un abbigliamento personalizzato farà la differenza nella tua attività.

garysworkwear.com



Ricami personalizzati

Stai pensando di personalizzare il tuo capo con un ricamo? Ricamiamo qualsiasi tipo di uniforme di lavoro. Grazie ai nostri macchinari di ultima generazione e al nostro team di specialisti, potrai ricamare il tuo logo o frase in alta qualità.



SCHIZZI E CARATTERISTICHE DEI CAPI

100800 Pág. 78



- Capi in maglia.
- Capi senza machine.
- A coste su scollo e orlo.
- Lunghezza circa: 63cm.
- Capo H2: semi-aderente.

100900 Pág. 82



- Capi in maglia.
- A coste su polsino, scollo e orlo.
- Lunghezza circa: 60 cm.
- Capo H2: semi-aderente.

102100 Pág. 80



- Capi in maglia.
- Capi senza maniche.
- A coste su scollo e orlo.
- Lunghezza circa: 66 cm.
- Capo H2: semi-aderente.

102200 Pág. 80



- Capi in maglia.
- Capi senza maniche.
- A coste su scollo e orlo.
- Lunghezza circa: 70 cm.
- Capo H2: semi-aderente.

102300 Pág. 81



- Capi in maglia.
- A coste su polsino, scollo e orlo.
- Lunghezza circa: 70 cm.
- Capo H2: semi-aderente.

102400 Pág. 81



- Capi in maglia.
- A coste su polsino, scollo e orlo.
- Lunghezza circa: 70 cm.
- Capo M2: semi-aderente.

102500 Pág. 79



- Capi in maglia.
- A coste su polsino e orlo.
- 2 tasche frontali.
- Lunghezza circa: 66 cm.
- Capo M2: semi-aderente.

102600 Pág. 79



- Capi in maglia.
- A coste su polsino e orlo.
- 2 tasche frontali.
- Lunghezza circa: 70 cm.
- Capo H2: semi-aderente.

102800 Pág. 83



- Capo in maglia spessa.
- Chiusura lampo frontale.
- Lunghezza circa: 66 cm.
- Capo H2: semi-aderente.

102900 Pág. 83



- Capo in maglia spessa.
- Chiusura lampo frontale.
- Lunghezza circa: 66 cm.
- Capo H2: semi-aderente.

103100 Pág. 84



- Capo in maglia fine.
- Chiusura lampo frontale.
- Lunghezza circa: 66 cm.
- Capo M2: semi-aderente.

103200 Pág. 85



- Capo in maglia fine.
- Chiusura lampo frontale.
- Lunghezza circa: 66 cm.
- Capo H2: semi-aderente.

107000 Pág. 146

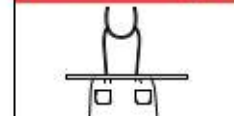

- Pettorina annodata.
- 2 tasche frontali.
- Lunghezza circa: 80 cm.

108000 Pág. 146
108000 VICHY Pág. 147



- 2 tasche frontali.
- Merletto su pettorina e tasche.
- Lunghezza circa: 80 cm.

111000 Pág. 146

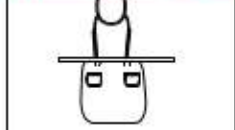

- Pettorina annodata.
- 2 tasche frontali.
- Merletto sui lati di pettorina e tasche.
- Lunghezza circa: 80 cm.

111900 Pág. 155



- Grembiule senza tasca.
- Bretelle da 20 mm dello stesso tessuto.
- Lunghezza circa: vedi pag. 155.

127000-115000 Pág. 140
115AT0



- Senza tasca.
- Lunghezza circa: 95 cm.

116000 Pág. 123



- Senza tasca.
- Lunghezza circa: 90 cm.

116BC0-116100 Pág. 123



- 1 tasca frontale.
- Lunghezza circa: 90 cm.

116300 Pág. 125

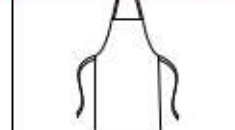

- Senza tasche.
- Lacci di cotone.
- Lunghezza circa: 90 cm.

116400 Pág. 125



- 1 tasca frontale.
- Lacci di cotone.
- Lunghezza circa: 90 cm.

117000 Pág. 130

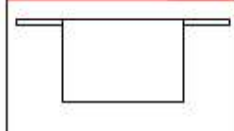

- Senza tasca.
- Lunghezza circa: 50 cm.

117B00-11745B Pág. 128
117100 Pág. 179

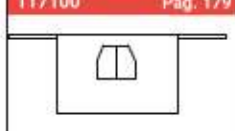

- 2 tasche frontali.
- Lunghezza circa: 50 cm.

118000 Pág. 116

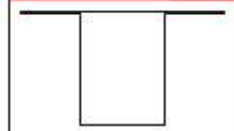

- Senza tasca.
- Lunghezza circa: 90 cm.

118B00 Pág. 117

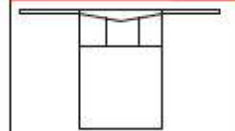

- 3 tasche frontali.
- Lunghezza circa: 90 cm.

118G000 Pág. 116

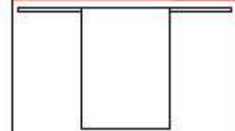

- Senza tasca.
- Lunghezza circa: 100 cm.

118GB0 Pág. 117

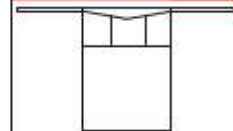

- 3 tasche frontali.
- Lunghezza circa: 100 cm.

120000-123100 Pág. 120
120600 Pág. 121

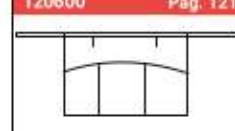

- 3 tasche frontali.
- Lunghezza circa: 30 cm.

120300 Pág. 140

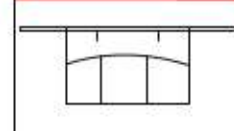

- 3 tasche frontali.
- Laccio di cotone.
- Lunghezza circa: 30 cm.

123000 Pág. 140

- Materiale PVC.
- Cordino regolare.
- Lunghezza circa: 110 cm.

124000 Pág. 142

- Materiale PVC/cotone.
- Cordino regolabile.
- Lunghezza circa: 90 cm.

125000 Pág. 141

- Materiale polipropilene.
- Cordino regolabile.
- Lunghezza circa: 90 cm.

126100 Pág. 141

- Materiale nitrile.
- Bretelle regolabili.
- Lunghezza circa: 115 cm.

126300 Pág. 142

- Materiale vinile.
- Lunghezza circa: 115 cm.

126400 Pág. 145

- Materiale poliuretano.
- Lunghezza circa: 115 cm.

H1 CAPI ADERENTI DA UOMO
H2 CAPI SEMI-ADERENTI DA UOMO
H3 CAPI AMPI DA UOMO

M1 CAPI ADERENTI DA DONNA
M1 CAPI SEMI-ADERENTI DA DONNA
M1 CAPI AMPI DA DONNA

149100 Pág. 108

- 1 tasca frontale.
- Laccio scamosciato.
- Lunghezza circa: 35 cm.

153300 Pág. 136

- Jeans délavé.
- Sistema di chiusura con fibbia.
- 1 tasca sul torace sinistro.
- 2 tasche laterali.
- Lunghezza circa: 95 cm.

153700 Pág. 137

- Jeans senza lavaggio.
- Sistema di chiusura regolabile con moschettoni.
- Tasca frontale.
- Lunghezza circa: 95 cm.

156100 Pág. 108

- Sistema di chiusura con asola e bottone.
- 1 tasca sul torace sinistro.
- 1 tasca sul lato destro.
- Lunghezza circa: 85 cm.

156300 Pág. 133

- Fibbia per regolare la bretella della pettorina.
- Sistema di chiusura con fibbia e bottoni per la pettorina.
- 4 tasche frontali.
- Lunghezza circa: 85 cm.

156400 Pág. 106

- Sistema di chiusura con fibbia e bottone a pressione per la pettorina.
- 1 tasca sul torace sinistro.
- 2 tasche frontali.
- Lunghezza circa: 72 cm.

156600 Pág. 108

- Sistema di chiusura sul lato sinistro con bottone a pressione.
- 1 tasca sul torace sinistro.
- 1 tasca sul lato sinistro.
- Lunghezza circa: 80 cm.

156700 Pág. 109

- Sistema di chiusura sul lato destro con fibbia e bottone.
- 3 tasche frontali.
- Lunghezza circa dalla pettorina: 85 cm.

157300 Pág. 103

- Sistema di chiusura con lacci incrociati dalla pettorina ai lati.
- 2 tasche frontali.
- Lunghezza circa: 76 cm.

157400 Pág. 170

- Sistema di chiusura con lacci incrociati dalla pettorina ai lati.
- 2 tasche frontali.
- Lunghezza circa: 76 cm.

157500 Pág. 102

- Lacci di regolazione del cordino.
- Passanti frontali.
- 2 tasche frontali.
- Lunghezza circa: 45 cm.

157600 Pág. 97

- Sistema di chiusura con laccio in pelle e occhielli.
- 4 tasche frontali.
- Lunghezza circa: 87 cm.

157700 Pág. 98

- Grembiule pareo con sistema di chiusura con fibbia.
- 1 tasca sul lato destro.
- Lunghezza circa: 70 cm.

157800 Pág. 97

- 3 tasche frontali smontabili con bottone e occhiello.
- 1 tasca sul lato destro.
- Lunghezza circa: 50 cm.

158100 Pág. 110

- Sistema di chiusura con lacci incrociati dalla pettorina ai lati.
- 1 tasca frontale.
- Lunghezza circa: 92 cm.

158400 Pág. 99

- Fibbia per regolare l'altezza della pettorina.
- 4 tasche frontali.
- Lunghezza circa: 86 cm.

158500 Pág. 170

- Apertura frontale.
- 2 tasche frontali.
- Lunghezza circa: 91 cm.

158600 Pág. 170

- Sistema di chiusura con lacci incrociati dalla pettorina ai lati.
- 1 tasca sul torace sinistro.
- 2 tasche frontali.
- Lunghezza circa: 92 cm.

158700 Pág. 101

- Sistema di chiusura con lacci incrociati dalla pettorina ai lati.
- 3 tasche frontali.
- Lunghezza circa: 87 cm.

158800 Pág. 100

- Tuta spigata sul davanti.
- 3 tasche frontali.
- Lunghezza circa: 50 cm.

159100 Pág. 126

- 1 tasca sul lato destro.
- Lunghezza circa: 30 cm.

159200 Pág. 111
161000-161100 Pág. 138













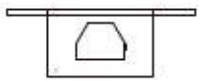
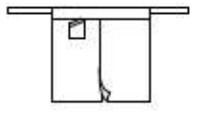
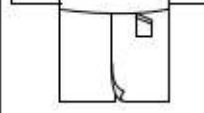
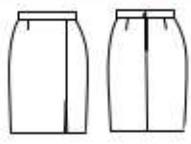
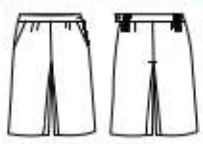

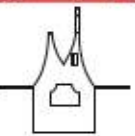
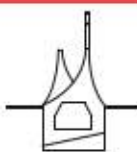

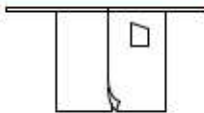
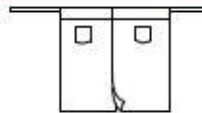
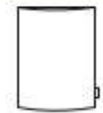
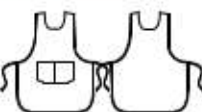



- Sistema di chiusura con fibbia.
- 1 tasca frontale.
- Lunghezza circa: 80 cm.

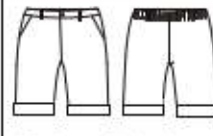

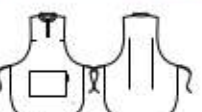
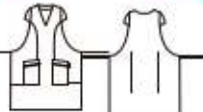











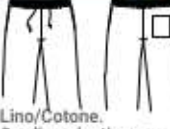

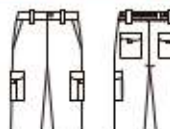
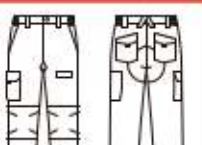









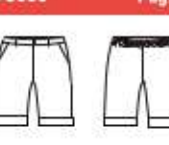

159300 Pág. 126

- 1 tasca frontale.
- Lunghezza circa: 47 cm.

159500 Pág. 171

- 2 tasche frontali.
- Lunghezza circa: 45 cm.

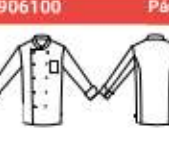
<p>159600 Pág. 172</p>  <ul style="list-style-type: none"> - 1 sistema di chiusura con fibbia. - 1 tasca frontale. - Lunghezza circa: 80 cm. 	<p>159700 Pág. 156</p>  <ul style="list-style-type: none"> - 1 sistema di chiusura con fibbia. - 1 tasca frontale. - Lunghezza circa: 80 cm. 	<p>159800 Pág. 174</p>  <ul style="list-style-type: none"> - 1 tasca frontale. - Lunghezza circa: 80 cm. 	<p>159900 Pág. 176</p>  <ul style="list-style-type: none"> - 1 tasca frontale. - Lunghezza circa: 47 cm. 	<p>175100 Pág. 135</p>  <ul style="list-style-type: none"> - Tasca sul lato destro. - Apertura centrale frontale. - Lunghezza circa: 90 cm. 	<p>175200 Pág. 135</p>  <ul style="list-style-type: none"> - Tasca sul lato sinistro. - Apertura centrale frontale. - Risvolto sulla vita. - Lunghezza circa: 90 cm. 	<p>176000 Pág. 95</p>  <ul style="list-style-type: none"> - Cintura, chiusura lampo e bottone posteriore - Apertura laterale. - Lunghezza circa: 55 cm. - Capo M1: aderente. 	<p>177400 Pág. 94</p>  <ul style="list-style-type: none"> - Chiusura lampo e bottone sul lato sinistro. - Elastico sui lati. - 2 tasche laterali. - Lunghezza circa: 56 cm. - Capo M2: semi-aderente
<p>180000 Pág. 132</p>  <ul style="list-style-type: none"> - 3 tasche frontali. - Sistema di chiusura con bottone piatto. - Lunghezza circa: 110 cm. 	<p>181000 Pág. 132</p>  <ul style="list-style-type: none"> - 1 tasca frontale. - Sistema di chiusura con fibbia. - Lunghezza circa: 68 cm. 	<p>182000-182V00 Pág. 113 182200 Pág. 112</p>  <ul style="list-style-type: none"> - Tasca penna sul torace. - Tasca frontale. - Sistema di chiusura con bottone piatto. - Lunghezza circa: 80 cm. 	<p>183000 Pág. 114</p>  <ul style="list-style-type: none"> - 1 tasca frontale. - Sistema di chiusura con bottone piatto - Lunghezza circa: 80 cm. 	<p>184100 Pág. 134</p>  <ul style="list-style-type: none"> - 1 tasca frontale. - Sistema di chiusura con bottone piatto - Lunghezza circa: 82 cm. 	<p>191000-191200 Pág. 118</p>  <ul style="list-style-type: none"> - 1 tasca sul lato sinistro. - Apertura centrale frontale. - Lunghezza circa: 90 cm. 	<p>191100 Pág. 136</p>  <ul style="list-style-type: none"> - Jeans délavé. - 2 tasche frontali. - Apertura centrale frontale. - Lunghezza circa: 90 cm. 	<p>200100-200200 Pág. 190</p>  <ul style="list-style-type: none"> - Bandana aerosilver. - Larghezza circa: 25 cm. - Lunghezza circa: 31 cm.
<p>202000-202200 Pág. 150 212300 Pág. 93</p>  <ul style="list-style-type: none"> - 2 tasche frontali. - Lacci laterali regolabili. - Dimensioni circa: 85x51 cm. 	<p>202300 Pág. 93 206300 Pág. 89</p>  <ul style="list-style-type: none"> - Ragazza vita bassa. - Senza cintura. - Bottone e chiusura lampo frontale. - Passanti sulla vita. - Lunghezza circa: 108 cm. - Capo M1.: aderente. 	<p>203200 Pág. 92</p>  <ul style="list-style-type: none"> - Ragazza vita alta. - Cintura, bottone e chiusura lampo frontale. - Passanti sulla vita. - Lunghezza circa: 108 cm. - Capo M2.:semi-aderente. 	<p>203400-206400 Pág. 84 205900 Pág. 166</p>  <ul style="list-style-type: none"> - Ragazza vita media. - Microfibra. - Passanti sulla vita. - Lunghezza circa: 111 cm. - Capo M1.: aderente. 	<p>203500 Pág. 92</p>  <ul style="list-style-type: none"> - Ragazza vita media. - 2 tasche sui lati. - Passanti sulla vita. - Lunghezza circa: 110 cm. - Capo M1.: aderente. 	<p>203600 Pág. 93</p>  <ul style="list-style-type: none"> - Ragazza vita media. - Cintura, bottone e chiusura lampo frontale. - Lunghezza circa: 110 cm. - Capo M1.: aderente. 	<p>204500 Pág. 94</p>  <ul style="list-style-type: none"> - Elastico sul girovita posteriore. - 2 tasche alla francese. - Passanti sulla vita. - Lunghezza circa: 46 cm. - Capo M2.:semi-aderente. 	<p>204700-205400 Pág. 87 206100-206200 Pág. 90</p>  <ul style="list-style-type: none"> - Serge smerigliato. - 2 tasche alla francese frontali e 2 con bordino posteriori. - Lunghezza circa: 109 cm. - Capo M2.:semi-aderente
<p>212400 Pág. 167</p>  <ul style="list-style-type: none"> - Collo alla coreana. - Lacci laterali regolabili. - 1 tasca frontale. - Pence su giromanica e schiena. - Dimensioni circa: 81x51 cm. 	<p>212500 Pág. 148</p>  <ul style="list-style-type: none"> - Lacci laterali regolabili. - 2 tasche frontali. - Pence su giromanica e schiena. - Dimensioni circa: 69x63 cm. 	<p>212600 Pág. 149</p>  <ul style="list-style-type: none"> - Lacci laterali regolabili. - 1 tasca sul lato destro. - Pence su giromanica e schiena. - Dimensioni circa: 82x70 cm. 	<p>243900 Pág. 168</p>  <ul style="list-style-type: none"> - Colletto. - Pence su giromanica frontale e schiena. - Lunghezza circa: 64 cm. - Capo M2:semi-aderente. 	<p>261100 Pág. 169</p>  <ul style="list-style-type: none"> - Slim fit. - Colletto. - Carré sulla schiena. - Lunghezza circa: 77 cm. - Capo H2: semi-aderente. 	<p>614800 Pág. 156</p>  <ul style="list-style-type: none"> - Tasca sul torace sinistro. - Tasca sul lato destro. - Pence su schiena e aperture. - Lunghezza circa: 75 cm. - Capo H2.: semi-aderente. 	<p>620100 Pág. 68</p>  <ul style="list-style-type: none"> - Collo alla coreana. - Tasca sul torace sinistro. - 2 tasche frontali. - Lunghezza circa: 68 cm. - Capo M2.:semi-aderente. 	<p>620200-620700 Pág. 68</p>  <ul style="list-style-type: none"> - Collo alla coreana. - Tasca sul torace sinistro. - 2 tasche frontali. - Lunghezza circa: 68 cm. - Capo M2.:semi-aderente.

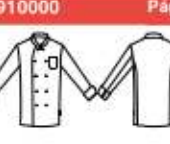
<p>645400 Pág. 47</p>  <ul style="list-style-type: none"> - 1 tasca sul torace sinistro. - 2 tasche frontali. - Lunghezza circa: 74 cm. - Capo H3: ampio. 	<p>652400 Pág. 47</p>  <ul style="list-style-type: none"> - 1 tasca sul torace sinistro. - 2 tasche frontali. - Lunghezza circa: 74 cm. - Capo H3: ampio. 	<p>700600-700700 Pág. 54 700900-701100 Pág. 61</p>  <ul style="list-style-type: none"> - Cordino elastico con parte finale. - 2 tasche interne sui fianchi e 1 toppa posteriore. - Lunghezza circa: 113 cm. - Capo H2: semi-aderente. 	<p>701200-702300 Pág. 52 701700 Pág. 61</p>  <ul style="list-style-type: none"> - Cordino elastico con parte finale. - 2 tasche interne sui fianchi e 1 toppa posteriore. - Lunghezza circa: 113 cm. - Capo H2: semi-aderente. 	<p>701500 Pág. 61</p>  <ul style="list-style-type: none"> - Jeans délavé. - Cordino elastico con parte finale. - 2 tasche interne sui fianchi e 1 toppa posteriore. - Lunghezza circa: 112 cm. - Capo H2: semi-aderente. 	<p>701800 Pág. 88</p>  <ul style="list-style-type: none"> - Lino/Cotone. - Cordino elastico con parte finale. - 2 tasche interne sui fianchi e 1 toppa posteriore. - Lunghezza circa: 118 cm. - Capo H2: semi-aderente. 	<p>703400-703500 Pág. 165 703600 Pág. 161</p>  <ul style="list-style-type: none"> - Cordino elastico con parte finale. - 2 tasche interne sui fianchi e 1 toppa posteriore. - Lunghezza circa: 113 cm. - Capo H2: semi-aderente. 	<p>750100 Pág. 205</p>  <ul style="list-style-type: none"> - Pantaloni multitasche. - Passanti sulla vita. - Lunghezza circa: 108 cm. - Capo H2: semi-aderente.
<p>750200 Pág. 203</p>  <ul style="list-style-type: none"> - Pantaloni multitasche. - Elastico sui lati 4 cm. - Passanti sulla vita. - Rinforzo sul cavallo. - Lunghezza circa: 108 cm. - Capo H2: semi-aderente. 	<p>770000-771000 Pág. 60 775000-776000</p>  <ul style="list-style-type: none"> - Elastico sul girovita posteriore. - 2 tasche alla francese all'interno dei lati. - Lunghezza circa: 112 cm. - Capo H2: semi-aderente. 	<p>772000-773000 Pág. 58</p>  <ul style="list-style-type: none"> - Elastico sul girovita posteriore. - Chiusura lampo e bottone frontale. - 2 tasche alla francese sui lati. - Lunghezza circa: 112 cm. - Capo H2: semi-aderente. 	<p>773G00-772G00 Pág. 56 773G0 Pág. 57</p>  <ul style="list-style-type: none"> - Elastico su tutta la vita. - Chiusura lampo e bottone frontale. - 2 tasche alla francese sui lati. - Lunghezza circa: 112 cm. - Capo H2: semi-aderente. 	<p>772500 Pág. 55</p>  <ul style="list-style-type: none"> - Elastico acrilico sulla pancia. - Regolabile con elastico interno. - 2 tasche alla francese. - Lunghezza circa: 113 cm. - Capo H2: semi-aderente. 	<p>777100-777200 Pág. 60</p>  <ul style="list-style-type: none"> - Elastico sul girovita posteriore. - 2 tasche alla francese sui lati e 1 toppa posteriore. - Lunghezza circa: 111 cm. - Capo H2: semi-aderente. 	<p>777500 Pág. 61</p>  <ul style="list-style-type: none"> - Cordino elastico con parti finali. - 2 tasche sui fianchi. - 2 tasche sui lati ginocchio. - Lunghezza circa: 108 cm. - Capo H2: semi-aderente. 	<p>777600-777700 Pág. 88</p>  <ul style="list-style-type: none"> - Chiusura lampo e bottone frontale. - 2 tasche alla francese sui lati e 1 posteriore. - Passanti sulla vita. - Lunghezza circa: 110 cm. - Capo H2: semi-aderente.
<p>777800-791500 Pág. 86 791600-791700 Pág. 90</p>  <ul style="list-style-type: none"> - Tessuto elasticizzato. - Serge smerigliato. - 4 tasche e 1 taschino. - Passanti sulla vita. - Lunghezza circa: 113 cm. - Capo H2: semi-aderente. 	<p>777900 Pág. 89</p>  <ul style="list-style-type: none"> - Microfibra. - 2 tasche alla francese sui lati e 1 posteriore. - Passanti sulla vita. - Lunghezza circa: 110 cm. - Capo H2: semi-aderente. 	<p>778500 Pág. 94</p>  <ul style="list-style-type: none"> - Elastico sul girovita posteriore. - 2 tasche alla francese. - Passanti sulla vita. - Lunghezza circa: 46 cm. - Capo H2: semi-aderente. 	<p>778600 Pág. 88</p>  <ul style="list-style-type: none"> - 2 tasche alla francese, 1 posteriore e 1 taschino. - Passanti sulla vita. - Lunghezza circa: 110 cm. - Capo H2: semi-aderente. 	<p>778900 Pág. 166</p>  <ul style="list-style-type: none"> - 2 tasche alla francese, 1 posteriore e 1 taschino. - Passanti sulla vita. - Lunghezza circa: 110 cm. - Capo H2: semi-aderente. 	<p>779500 Pág. 168</p>  <ul style="list-style-type: none"> - 2 tasche alla francese, 1 posteriore e 1 taschino. - Passanti sulla vita. - Lunghezza circa: 110 cm. - Capo H2: semi-aderente. 	<p>851100 Pág. 74</p>  <ul style="list-style-type: none"> - Polo piqué con colletto. - Coste sul polsino. - Lunghezza circa: 67 cm. - Capo M1: aderente. 	<p>851500 Pág. 74</p>  <ul style="list-style-type: none"> - Polo piqué con colletto. - Coste sul polsino. - Lunghezza circa: 60 cm. - Capo M1: aderente.
<p>852600 Pág. 77</p>  <ul style="list-style-type: none"> - Polo red-line. - Tessuto CoolMax. - Collo alla coreana con tessuto in jeans. - Lunghezza circa: 72 cm. - Capo H1: aderente. 	<p>852700 Pág. 77</p>  <ul style="list-style-type: none"> - Polo red-line. - Tessuto coolmax. - Colletto. - Lunghezza circa: 72 cm. - Capo H1: aderente. 	<p>852900 Pág. 77</p>  <ul style="list-style-type: none"> - Polo red-line. - Tessuto coolmax. - Colletto. - Lunghezza circa: 65 cm. - Capo H1: aderente. 	<p>853100 Pág. 77</p>  <ul style="list-style-type: none"> - Polo red-line. - Tessuto coolmax. - Collo alla coreana con tessuto in jeans. - Lunghezza circa: 65 cm. - Capo H1: aderente. 	<p>906100 Pág. 34</p>  <ul style="list-style-type: none"> - Bottone foderato cucito. - Tasca sul torace sinistro. - Lunghezza circa: 74 cm. - Capo H3: ampio. 	<p>907000 Pág. 32</p>  <ul style="list-style-type: none"> - Bottone foderato cucito. - Tasca sul torace sinistro. - Lunghezza circa: 72 cm. - Capo H2: semi-aderente. 	<p>908000 Pág. 32</p>  <ul style="list-style-type: none"> - Bottone foderato cucito. - Tasca sul torace sinistro. - Lunghezza circa: 72 cm. - Capo H2: semi-aderente. 	<p>910000 Pág. 33</p>  <ul style="list-style-type: none"> - Bottone piatto. - Tasca sul torace sinistro. - Lunghezza circa: 72 cm. - Capo H2: semi-aderente.

911000-915000 Pág. 46
916000-917A00



- Bottoni piatti.
- Tasca sul torace sinistro.
- Lunghezza circa: 72 cm.
- Capo H2: semi-aderente.

912000 Pág. 43

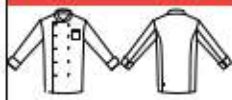

- Bottoni piatti.
- Tasca sul torace sinistro.
- Bordino su scollo frontale, tasca e polsini.
- Lunghezza circa: 72 cm.
- Capo H2: semi-aderente.

914000 Pág. 43



- Bottoni piatti.
- Tasca sul torace sinistro.
- Bordino su scollo frontale, tasca e maniche.
- Lunghezza circa: 72 cm.
- Capo H2: semi-aderente.

918000 Pág. 37



- Bottoni non inclusi.
- Pence su torace e schiena.
- Lunghezza circa: 72 cm.
- Capo M2: semi-aderente.

919100 Pág. 51

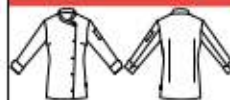

- Bottoni a sfera.
- Tasca su manica sinistra.
- Pence su torace e schiena.
- Lunghezza circa: 68 cm.
- Capo M2: semi-aderente.

930400 Pág. 36



- Bottoni non inclusi.
- Tasca sul torace sinistro.
- Lunghezza circa: 75 cm.
- Capo H3: ampio.

930500 Pág. 44



- Bottoni a sfera.
- Tasca sul torace sinistro.
- Bordino su collo, polsini e tasca.
- Lunghezza circa: 75 cm.
- Capo H3: ampio.

930700 Pág. 50



- Bottoni a sfera.
- Tasca su torace e manica.
- Lunghezza circa: 75 cm.
- Capo H3: ampio.

930800 Pág. 35



- Bottoni a sfera.
- Tasca sul torace sinistro.
- Lunghezza circa: 75 cm.
- Capo H3: ampio.

931000 Pág. 33

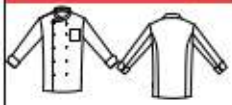

- Antimacchia teflon.
- Bottoni a sfera.
- Tasca sul torace sinistro.
- Lunghezza circa: 75 cm.
- Capo H3: ampio.

931400 Pág. 35



- Bottoni a pressione nascosti.
- Tasca su torace e manica sinistra.
- Lunghezza circa: 75 cm.
- Capo H3: ampio.

940100 Pág. 09

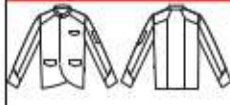

- Bottoni a pressione nascosti.
- False tasche a busta frontali.
- Tasca su manica sinistra.
- Lunghezza circa: 74cm.
- Capo H2: semi-aderente.

940200 Pág. 4



- Bottoni a pressione metallici.
- False tasche a busta frontali.
- Tasca su manica sinistra.
- Lunghezza circa: 74cm.
- Capo H2: semi-aderente.

940300 Pág. 6



- Bottoni a pressione metallici.
- 2 tasche frontali.
- Dettagli in similpelle.
- Tasca su manica sinistra.
- Lunghezza circa: 74cm.
- Capo H2: semi-aderente.

940400 Pág. 08



- Bottoni a pressione metallici.
- 4 tasche frontali, 2 comprese su pence sulla vita.
- Fibbia sulle spalle.
- Lunghezza circa: 74cm.
- Capo H2: semi-aderente.

940500 Pág. 7



- Bottoni a pressione metallici.
- 2 tasche, 1 sulla manica frontale e finta tasca a busta sul torace.
- Lunghezza circa: 74cm.
- Capo H2: semi-aderente.

941000 Pág. 49

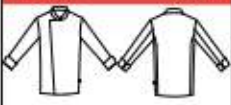

- Senza bottoni.
- Chiusura con velcro.
- Senza tasche.
- Lunghezza circa: 75 cm.
- Capo H3: ampio.

942100 Pág. 42



- Primo bottone a pressione visibile, i restanti sono nascosti.
- Aerosilver sui lati.
- Lunghezza circa: 69 cm.
- Capo M2: semi-aderente.

942200 Pág. 45



- Bottoni a pressione nascosti.
- Senza tasche.
- Aerosilver sui lati.
- Lunghezza circa: 69 cm.
- Capo M2: semi-aderente.

942300 Pág. 11

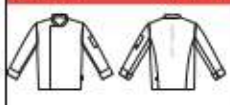

- Bottoni a pressione nascosti.
- 1 tasca su manica sinistra.
- Aerosilver sulla schiena.
- Lunghezza circa: 74 cm.
- Capo H2: semi-aderente.

942400 Pág. 164



- Bottoni a pressione nascosti.
- 1 Tasca su manica sinistra.
- Aerosilver sulla schiena.
- Lunghezza circa: 78 cm.
- Capo H2: semi-aderente.

942500 Pág. 163



- Aerosilver sulla schiena.
- Bottoni a pressione nascosti.
- 1 Tasca su manica sinistra.
- Bordini su polsino e torace.
- Lunghezza circa: 74 cm.
- Capo H2: semi-aderente.

942600 Pág. 162



- Aerosilver sulla schiena.
- Bottoni a pressione nascosti.
- 1 Tasca su manica sinistra.
- Bordini su polsino e parte frontale.
- Lunghezza circa: 74 cm.
- Capo H2: semi-aderente.

942700 Pág. 160



- Bottoni a pressione nascosti.
- 1 Tasca su manica sinistra.
- Aerosilver sulla schiena.
- Lunghezza circa: 74 cm.
- Capo H2: semi-aderente.

942800 Pág. 30

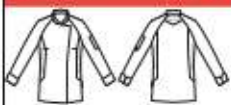

- Bottoni a pressione nascosti.
- 1 Tasca su manica sinistra.
- Aerosilver sui lati.
- Lunghezza circa: 72 cm.
- Capo M2: semi-aderente.

942900 Pág. 163



- Aerosilver sulla schiena.
- Bottoni a pressione nascosti.
- 1 Tasca su manica sinistra.
- Bordini su polsino e torace.
- Lunghezza circa: 71 cm.
- Capo M2: semi-aderente.

943100 Pág. 161



- Aerosilver sulla schiena.
- 1 bottone in cocco visibile.
- Bottoni a pressione nascosti.
- 1 Tasca su manica sinistra.
- Bordini su polsino e parte frontale.
- Lunghezza circa: 74 cm.
- Capo H2: semi-aderente.

944100 Pág. 16



- Aerosilver sulla schiena.
- 1 bottone in cocco visibile.
- Bottoni a pressione nascosti.
- 1 Tasca su manica sinistra.
- Bordini su polsino e parte frontale.
- Lunghezza circa: 74 cm.
- Capo H2: semi-aderente.

944200 Pág. 16



- Bottoni a pressione nascosti.
- 1 Tasca su manica sinistra.
- Aerosilver sulla schiena.
- Lunghezza circa: 73 cm.
- Capo H2: semi-aderente.

944300 Pág. 48



- Jeans délavé.
- Bottoni a pressione nascosti.
- 2 tasche su torace e manica.
- Aerosilver sulla schiena.
- Lunghezza circa: 73 cm.
- Capo H2: semi-aderente.

944600 Pág. 40



- Bottoni a pressione nascosti.
- 1 Tasca su manica sinistra.
- Aerosilver sulla schiena.
- Bordino su scollo e polsino.
- Lunghezza circa: 73 cm.
- Capo H2: semi-aderente.

944800 Pág. 42



- Bottoni a pressione nascosti.
- 1 Tasca su manica sinistra.
- Aerosilver sui lati.
- Bordino su scollo e polsino.
- Lunghezza circa: 73 cm.
- Capo H2: semi-aderente.

944900 Pág. 38



- Coste elastiche sui polsini e giromanica schiena.
- Aerosilver sulla schiena.
- Lunghezza circa: 73 cm.
- Capo H2: semi-aderente.

945100 Pág. 40



- Bottoni a pressione visibili.
- Tasca su manica sinistra.
- Manica corta.
- Lunghezza circa: 73 cm.
- Capo H2: semi-aderente.

945200 Pág. 41



- Bottoni a pressione visibili.
- Tasca su manica sinistra.
- Lunghezza circa: 73 cm.
- Capo H2: semi-aderente.

945400 Pág. 39



- Bottoni a pressione nascosti.
- Tasca su manica sinistra.
- Lunghezza circa: 74 cm.
- Capo H2: semi-aderente.

945500 Pág. 28

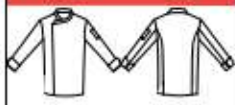

- Bottoni a pressione nascosti.
- Tasca su manica sinistra.
- Aerosilver sui lati.
- Lunghezza circa: 74 cm.
- Capo H2: semi-aderente.

945800 Pág. 45



- Bottoni a pressione nascosti.
- Aerosilver sui lati.
- Lunghezza circa: 71 cm.
- Capo H2: semi-aderente.

946300 Pág. 44



- Bottoni a pressione nascosti.
- Tasca sul torace sinistro.
- Aerosilver sui lati.
- Lunghezza circa: 73 cm.
- Capo H2: semi-aderente.

946600 Pág. 21



- Manica roll-up.
- Bottoni a pressione nascosti.
- Tasca sul torace sinistro.
- Lunghezza circa: 73 cm.
- Capo H2: semi-aderente.

946700 Pág. 20

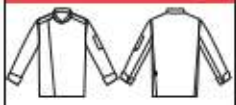

- Bottoni a pressione nascosti.
- Tasca su manica sinistra.
- Jeans, dettagli scamosciati.
- Lunghezza circa: 74 cm.
- Capo H2: semi-aderente.

946800 Pág. 25



- Bottoni a pressione nascosti.
- Manica roll-up.
- Senza tasche.
- Lunghezza circa: 74 cm.
- Capo H2: semi-aderente.

947100 Pág. 24



- Bottoni a pressione nascosti.
- Tasca su manica sinistra.
- Tessuto satin elasticizzato.
- Lunghezza circa: 74 cm.
- Capo H2: semi-aderente.

947200 Pág. 25

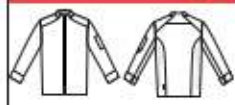

- Chiusura lampo.
- Tasca su manica sinistra.
- Aerosilver sui lati.
- Lunghezza circa: 74 cm.
- Capo H2: semi-aderente.

947300 Pág. 29



- Bottoni a pressione nascosti.
- Tasca su manica sinistra.
- Aerosilver su giromanica schiena.
- Lunghezza circa: 74 cm.
- Capo H2: semi-aderente.

947400 Pág. 12



- Aerosilver sulla schiena.
- Bottoni a pressione nascosti.
- Tasca su manica sinistra.
- Microfibra sublimata.
- Lunghezza circa: 74 cm.
- Capo H2: semi-aderente.

947500 Pág. 15



- Bottoni a pressione nascosti.
- Tasca su manica sinistra.
- Aerosilver sulla schiena.
- Lunghezza circa: 74 cm.
- Capo H2: semi-aderente.

947600 Pág. 14



- Aerosilver sulla schiena.
- Bottoni a pressione nascosti.
- Tasca su manica sinistra.
- Microfibra sublimata.
- Lunghezza circa: 74 cm.
- Capo H2: semi-aderente.

947700 Pág. 23



- Bottoni a pressione nascosti.
- Senza tasche.
- Tessuto in jeans délavé.
- Lunghezza circa: 74 cm.
- Capo H2: semi-aderente.

947800 Pág. 31



- Aerosilver sulla schiena.
- Bottoni a pressione nascosti.
- Manica roll-up.
- Tasca sul torace.
- Lunghezza circa: 74 cm.
- Capo H2: semi-aderente.

947900 Pág. 14



- Bottoni a pressione nascosti.
- Tasca manica sinistra.
- Aerosilver sui lati.
- Lunghezza circa: 74 cm.
- Capo H2: semi-aderente.

948100 Pág. 21



- Bottoni a pressione nascosti.
- Maniche roll-up.
- Tasca sul torace sinistro.
- Lunghezza circa: 71 cm.
- Capo M1: aderente.

948200 Pág. 29



- Bottoni a pressione nascosti.
- Tasca su manica sinistra.
- Aerosilver sulla schiena.
- Lunghezza circa: 74 cm.
- Capo H2: semi-aderente.

948400 Pág. 40



- Bottoni a pressione nascosti.
- Bordo con cordino su scollo e maniche.
- Aerosilver sulla schiena.
- Lunghezza circa: 71 cm.
- Capo M2: semi-aderente.

948500 Pág. 16



- Bottoni a pressione nascosti.
- Tasca su manica sinistra.
- Aerosilver sulla schiena.
- Lunghezza circa: 71 cm.
- Capo M2: semi-aderente.

948600 Pág. 16



- Bottoni a pressione nascosti.
- Tasca su manica sinistra.
- Aerosilver sulla schiena.
- Lunghezza circa: 71 cm.
- Capo M2: semi-aderente.

948700 Pág. 31



- Bottoni a pressione nascosti.
- Manica roll-up.
- Aerosilver sulla schiena.
- Lunghezza circa: 71 cm.
- Capo M2: semi-aderente.

948800 Pág. 22



- Bottoni a pressione nascosti.
- Tasca su manica sinistra.
- Aerosilver sulla schiena.
- Lunghezza circa: 74 cm.
- Capo H2: semi-aderente.

949100 Pág. 22



- Bottoni a pressione nascosti.
- Tasca su manica sinistra.
- Aerosilver sui lati.
- Lunghezza circa: 74 cm.
- Capo H2: semi-aderente.

949200 Pág. 18



- Bottoni a pressione nascosti.
- Tasca su manica sinistra.
- Aerosilver sulla schiena.
- Lunghezza circa: 74 cm.
- Capo H2: semi-aderente.

949300 Pág. 18



- Bottoni a pressione nascosti.
- Tasca su manica sinistra.
- Aerosilver sui lati.
- Lunghezza circa: 74 cm.
- Capo H2: semi-aderente.

949500 Pág. 26



- Bottoni a pressione nascosti.
- Tasca su manica sinistra.
- Aerosilver sulla schiena.
- Lunghezza circa: 74 cm.
- Capo H2: semi-aderente.

949600 Pág. 11

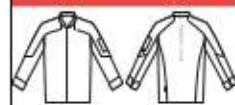

- Bottoni a pressione nascosti.
- Tasca su manica sinistra.
- Aerosilver sulla schiena.
- Lunghezza circa: 74 cm.
- Capo H2: semi-aderente.

949700 Pág. 30



- Bottoni a pressione nascosti.
- Tasca su manica sinistra.
- Aerosilver sui lati.
- Lunghezza circa: 74 cm.
- Capo H2: semi-aderente.

949800 Pág. 27



- Aerosilver sulla schiena.
- Manica lunga e polsino con risvolto.
- Bottoni a pressione nascosti.
- Tasca su manica sinistra.
- Lunghezza circa: 74 cm.
- Capo H2: semi-aderente.

949900 Pág. 13



- Aerosilver sulla schiena.
- Manica lunga e polsino con risvolto.
- Bottoni a pressione nascosti.
- Tasche su torace e manica.
- Lunghezza circa: 74 cm.
- Capo H2: semi-aderente.

950100-950200 Pág. 154



- Bottoni a sfera.
- Tasca su manica sinistra.
- Lunghezza circa: 47 cm nella taglia 4 e 70 cm nella taglia 14.

953000-963000 Pág. 68
963400 Pág. 69



- Polsino abbottonato.
- Bottoni piatti.
- 3 tasche frontali.
- Lunghezza circa: 75 cm.
- Capo H2: semi-aderente.

960000-961000 Pág. 70



- Collo smoking.
- 1 bottone piatto.
- 3 tasche frontali.
- Lunghezza circa: 75 cm.
- Capo H2: semi-aderente.

963200-963500 Pág. 63



- Polsini abbottonati.
- Bottoni piatti.
- 3 tasche frontali.
- Lunghezza circa: 68 cm.
- Capo M2: semi-aderente.

963300 Pág. 63



- Polsini abbottonati.
- Bottoni piatti.
- 3 tasche frontali.
- Lunghezza circa: 76 cm.
- Capo H2: semi-aderente.

963600 Pág. 73



- Polsini abbottonati.
- Bottoni a pressione nascosti.
- 3 tasche frontali.
- Lunghezza circa: 74 cm.
- Capo H2: semi-aderente.

963700 Pág. 73



- Polsini abbottonati.
- Bottoni a pressione nascosti.
- 3 tasche frontali.
- Lunghezza circa: 75 cm.
- Capo M2: semi-aderente.

963800 Pág. 166



- Polsino abbottonato.
- Bottoni a pressione nascosti.
- Tasche frontali.
- Lunghezza circa: 75 cm.
- Capo H2: semi-aderente.

963900 Pág. 166



- Polsino abbottonato.
- Bottoni a pressione nascosti.
- Tasche frontali.
- Lunghezza circa: 71 cm.
- Capo M2: semi-aderente.

965000 Pág. 71



- Collo smoking.
- 1 bottone piatto.
- Pence frontali.
- Lunghezza circa: 75 cm.
- Capo H2: semi-aderente.

990000 Pág. 72



- Collo smoking.
- Bottoni piatti.
- 2 tasche frontali.
- Lunghezza circa: 56 cm.
- Capo H2: semi-aderente.

99700-993100 Pág. 72



- Collo smoking.
- Bottoni piatti.
- 2 tasche frontali.
- Lunghezza circa: 56 cm.
- Capo H2: semi-aderente.

998000-993300 Pág. 62



- Bottoni piatti.
- 2 tasche frontali.
- Lati aderenti.
- Lunghezza circa: 56 cm.
- Capo M1: aderente.

993400 Pág. 67



- Bottoni piatti.
- 2 tasche frontali.
- Lati aderenti.
- Lunghezza circa: 50 cm.
- Capo M1: aderente.

994600 Pág. 67



- Bottoni piatti.
- 2 tasche frontali.
- Lati aderenti.
- Lunghezza circa: 58 cm.
- Capo H1: aderente.

994700 Pág. 65



- Bottoni a pressione metallici.
- 2 tasche frontali.
- Lati aderenti.
- Lunghezza circa: 56 cm.
- Capo M1: aderente.

994800 Pág. 65



- Bottoni a pressione metallici.
- 2 tasche frontali.
- Lati aderenti.
- Lunghezza circa: 61 cm.
- Capo H1: aderente.

113F00 Pág. 95

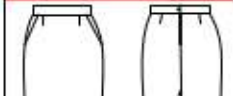

- Cintura, chiusura lampo e bottone posteriore con apertura.
- 2 tasche alla francese laterali.
- Lunghezza circa: 55 cm.
- Capo M1: aderente.

Misure



Queste misure vengono prese sulla persona per assegnare la taglia appropriata. *These measures are taken to provide each person with the appropriate size.*

CM.		MISURE BASE RAGAZZA: CAPI SUPERIORI E PANTALONI STANDARD WOMEN'S UPPER GARMENTS AND TROUSER SIZES															
TAGLIE	SIZES	P				M				G				SG			
		XSS	XS		S		M		D		XL		XXL		YL		
		34	36	38	40	42	44	46	48	50	52	54	56	58	60	62	64
TORACE	BUST	78-81	82-85	86-90	90-93	94-97	98-101	12-105	106-109	110-113	114-117	118-121	122-125	126-129	130-133	134-137	138-141
VITA	WAIST	60	64	68	72	76	80	84	88	92	96	100	104	108	112	116	120
FIANCHI	HIPS	84	88	92	96	100	104	108	112	116	120	124	128	132	136	140	144



CM.		MISURE BASE RAGAZZO STANDARD MEN'S SIZES															
TAGLIE	SIZES	P				M				G				SG			
		XSS	XS		S		M		D		XL		XXL		YL		
		40	42	44	46	48	50	52	54	56	58	60	62	64	66	68	
TORACE	BUST	78-81	82-85	86-89	90-93	94-97	98-101	102-105	106-109	110-113	114-117	118-121	122-125	126-129	130-133	134-137	
VITA	WAIST	66	70	74	78	82	86	90	94	98	102	106	110	114	118	122	
FIANCHI	HIPS	78	82	86	90	94	98	102	106	110	114	118	122	126	130	134	

CM.		MISURE BASE CAMICIE RAGAZZO STANDARD MEN'S SHIRT SIZES									
TAGLIE	SIZES	XS	S	M	D	XL	XXL	YL	2YL		
		1	2	3	4	5	6	7	8		
		36	38	40	42	44	46	48	50	52	54
COLLO	NECK	36	38	40	42	44	46	48	50	52	54

CM.		MISURE BASE PANTALONI RAGAZZO UNISEX STANDARD MEN'S AND UNISEX TROUSER SIZES														
TAGLIE	SIZES	XS		S		M		D		XL		XXL		YL		
		34	36	38	40	42	44	46	48	50	52	54	56	58	60	62
VITA	WAIST	68	72	76	80	84	88	92	96	100	104	108	112	116	120	124

La nostra azienda

Gary's Workwear fu creato nel 2001 dal suo attuale gestore nel piccolo paese di Vélez Rubio (Almería, Spagna). Puntare continuamente sull'innovazione e sulla qualità (sia nel servizio che nei materiali) ha portato l'azienda a una costante ricerca dell'eccellenza, ottenendo così materie prime di altissimo

livello e uno straordinario team che lavora con impegno nell'azienda.

Nel 2019, dopo essersi affermata tra i leader del settore a livello nazionale e dopo anni di rapporti commerciali al di fuori della Spagna, inizia l'internazionalizzazione dell'azienda su vasta scala.



Seguici sui nostri social network



gary's Happier
Workplaces



gary's Happier
Workplaces

@Uniformes Gary's

È proibita la riproduzione totale o parziale di questo catalogo, e il suo trattamento in qualsiasi modo o mediante qualsiasi mezzo senza il consenso scritto ed esplicito dell'azienda titolare del copyright.

gary's WORKWEAR

Grembiuli & Accessori

Tabliers & Accessoires



Happier Workplaces

Scopri tutta la nostra collezione di grembiuli e accessori professionali; un nuovo modo di capire l'abbigliamento da lavoro.

Vi presentiamo una perfetta fusione tra moda e ospitalità.

Troverai un'ampia varietà di pezzi perfetti come parte della tua uniforme.

Découvrez toute notre collection de tabliers et accessoires professionnels; une nouvelle façon d'appréhender les vêtements de travail. Ainsi, nous vous présentons une fusion parfaite entre la mode et l'hôtellerie

Vous trouverez une grande variété de pièces parfaites dans le cadre de votre uniforme.

REF.	PAGE	REF.	PAGE	REF.	PAGE	REF.	PAGE	REF.	PAGE
100001	26	148500	30	161600	42	330700	54	461200	62
100005	40	148600	36	175100	20	330800	54	461300	62
100006	38	148700	34	175200	20	330900	43	461400	62
100007	40	148800	31	177100	33	350100	61	470000	60
100008	38	149100	8	177200	35	400000	52	115AT0	23
100009	39	149200	43	180000	19	400001	50	116BC0	16
100011	40	149300	42	181000	19	400002	50	11745B	17
100012	38	149400	42	182000	15	401000	52	117B00	17
100013	38	149500	42	182200	15	405000	52	118B00	12
100014	41	153300	21	183000	8	405100	51	118G00	12
100015	41	153700	21	184100	3	410000	51	118GB0	12
100016	39	155100	34	191000	13	410100	51	1200Z0	60
100017	38	155200	36	191100	21	415000	51	182V00	15
100018	38	155300	32	191200	13	416000	51	445V00	47
100019	37	155400	30	200100	49	420000	51	446V00	46
100021	37	155500	36	200200	49	422000	51	447V00	46
100022	38	155600	37	220001	50	421000	51	4481V0	47
100023	38	155700	36	310100	60	435000	51	4482V0	47
100028	25	155800	34	321000	58	440000	51		
107000	22	155900	31	322000	56	441100	48		
108000	22	156100	8	323000	56	441200	48		
111000	22	156300	3	324000	59	441400	48		
111600	27	156400	9	325000	60	441500	45		
111800	27	156600	8	326100	58	441700	45		
111900	27	156700	8	326200	57	441800	48		
115000	23	157300	7	326300	56	445100	44		
116000	18	157400	28	326400	59	445200	44		
116100	16	157500	7	326500	59	445300	44		
116300	19	157600	3	326600	58	446100	52		
116400	19	157700	4	326700	59	446200	52		
117000	18	157800	3	326800	57	447100	49		
117100	17	158100	10	326900	59	447500	45		
118000	12	158400	4	327100	56	447800	48		
120000	14	158500	4	327200	56	447900	48		
120300	18	158600	28	327300	56	448400	45		
120600	14	158700	6	327400	55	448600	45		
123000	23	158800	6	327500	55	448800	46		
123100	21	159100	11	327600	55	448900	46		
124000	24	159200	10	329000	54	449100	51		
125000	23	159300	11	329100	54	449200	46		
126100	23	159500	28	329300	54	449300	46		
126200	24	159600	28	329400	53	449700	45		
126300	24	159700	25	329500	53	450000	61		
126400	25	159800	29	330100	54	450100	45		
126500	25	159900	29	330200	54	450300	45		
127000	8	161000	20	330300	54	459700	52		
148100	32	161100	5	330400	54	459800	52		
148200	35	161200	43	330500	53	459900	52		
148300	33	161300	42	330600	9	460000	61		
148400	35	161400	42						



c/001 Nero/Noir

RIF/REF. 156300

Unisex con tasca
Unisex avec poche
Finitura satinata
Finition satiné
Taglia unica/Taille unique
Twill/Serge 300 gr/m²
50%PES 50%CO



RIF/REF 184100

Unisex con tasca
Unisex avec poche
Taglia unica/Taille unique
82x77 cm.
Twill/Serge 220 gr/m²
100%PES

c/608 Grigio marengo/Gris marengo

c/625 Riga diplomatica/Ligne diplomatique



RIF/REF 157800

Unisex con tasche/Unisex avec poche
Taglia unica/Taille unique, 58x68 cm.
Tela/Toile 290gr/m²
85%CO 15%PES

c/148 Indaco/Indigo

RIF/REF. 157600

Unisex con tasca/Unisex avec poche
Taglia unica/Taille unique, 87x73 cm.
Tela/Toile 290gr/m²
85%CO 15%PES

c/148 Indaco/Indigo

RIF/REF. 157700
Unisex con tasca
Unisex avec poche
Taglie/Tailles P-M-G
Tela/Toile 290gr/m²
85%CO 15%PES

c/148 Indaco/Indigo



RIF/REF. 158500
Unisex con tasca
Unisex avec poche
Taglia unica/Taille unique
91x108 cm.
Tela/Toile 290gr/m²
85%CO 15%PES

c/148 Indaco/Indigo



RIF/REF. 158400
Unisex con tasche
Unisex avec poches
Taglia unica/Taille unique
86x77 cm.
Tela/Toile 290gr/m²
85%CO 15%PES

c/148 Indaco/Indigo



RIF/REF. 161100
Unisex con tasca/Unisex avec poche
Taglia unica/Taille unique
95x75 cm.
Twill/Serge 210gr/m²
100% CO



c/5108 Catrina

c/5119 Vegetal

100% Cotone.
Coton.



c/5103 Camuflaje

c/5101 Dévas

c/5102 Guindillas

c/5102 Maderas

RIF/REF. 158800

Unisex con tasche/Unisex avec poches
Taglia unica/Taille unique. 50x68 cm.
Twill rustica/Serge rustique 205 gr/m²
50%PES 50%CO



c/104 Blu navy/Bleu marine

c/124 Marrone/Marron

c/112 Bordeaux

RIF/REF. 158700

Unisex con tasche/Unisex avec poches
Taglia unica/Taille unique. 87x74 cm.
Twill rustica/Serge rustique 205 gr/m²
50%PES 50%CO



c/112 Bordeaux

c/104 Blu navy/Bleu marine

c/124 Marrone/Marron



c/112 Bordeaux

c/104 Blu navy/Bleu marine

RIF/REF. 157300
Unisex con tasche/Unisex avec poches
Taglia unica/Taille unique. 76x68 cm.
Loneta/Toile 290 gr/m²
85%CO 15%PES



RIF/REF. 157500
Unisex con tasche/Unisex avec poches
Taglia unica/Taille unique. 45x68 cm.
Loneta/Toile 290 gr/m²
85%CO 15%PES

c/104 Blu navy/Bleu marine

c/112 Bordeaux



1. RIF/REF. 156100
 Unisex con tasca
 Unisexe avec poche
 Taglia unica/Taille unique
 85x80 cm.
 Twill/Serge 200gr/m²
 65%PES 35%CO

c/152 Blu grigiastro/Bleu grisâtre

2. RIF/REF. 149100
 Unisex con tasca
 Unisexe avec poche
 Taglia unica/Taille unique
 35x57 cm.
 Twill/Serge 200gr/m²
 65%PES 35%CO

c/152 Blu grigiastro/Bleu grisâtre

RIF/REF. 156600
 Unisex con tasca
 Unisexe avec poche
 Taglia unica/Taille unique
 80x68 cm.
 Twill/Serge 240gr/m²
 65%PES 35%CO

c/149 Verde kaki/Vert kaki



c/153 Blu petrolio/Bleu pétrole

c/001 Nero/Noir

c/149 Verde kaki/Vert kaki

RIF/REF. 156700
 Unisex con tasche/Unisexe avec poches
 Taglia unica/Taille unique. 86x91 cm.
 Twill/Serge 240gr/m²
 65%PES 35%CO



RIF/REF. 183000
 Unisex con tasca/Unisexe avec poche
 Taglia unica/Taille unique. 80x65 cm.
 Twill/Serge 200 gr/m²
 65%PES 35%CO



c/112

Bordeaux

c/127

Pistacchio
Pistache

c/115

Turchese
Turquoise

c/125

Fucsia
Fuchsia

c/138

Lampona
Framboise

c/117

Grigio perla
Gris perle



RIF/REF. 127000
 Unisex senza tasca/Unisexe sans poche
 Taglia unica/Taille unique.
 95x75 cm.
 Liscio/Unie 265 gr/m²
 70%PES 30%PAC



c/108 Verde/Vert

c/110 Beige

c/105 Rosso/Rouge



c/001 Nero/Noir



c/154 Verde musgo/Vert musgo



c/153 Blu petrolio/Bleu pétrole



c/151 Cammello/Chameau



c/149 Verde kaki/Vert kaki



c/147 Cioccolato
Chocolat

Combinare il tuo grembiule Combine ton tableur

con nastri in pelle coordinati
avec des rubans en cuir assortis



c/151 Cammello
Chameau

c/142 Sabbia/Sable

c/141 Avorio/ivoire

c/147 Cioccolato/Chocolat

c/001 Nero/Noir

RIF/REF. 330600 STRISCE DI CUIO
BANDE DE CUIR
70 cm

RIF/REF. 156400

Unisex con tasca/Unisex avec poche
Taglia unica/Taille unique. 72x80 cm.
Twill/Serge 240gr/m²
65%PES 35%CO

Ogni grembiule include il cinturino in pelle dans les nelle seguenti combinazioni:
Chaque tableur comprend une sangle en cuir combinations suivantes:

- GREMBIULE NERO - NASTRO NERO/TABLIER NOIR - RUBAN NOIR
- GREMBIULE CAMMELLO - NASTRO AL CIOCCOLATO/TABLIER CAMEL - RUBAN CHOCOLAT
- GREMBIULE V. KAQUI - NASTRO CAMMELLO/TABLIER V.KAQUI - RUBAN CAMEL
- GREMBIULE V. MOSS - NASTRO AL CIOCCOLATO/TABLIER V. MOSS - RUBAN CHOCOLAT
- GREMBIULEA. OLIO - CAMMELLO DI NASTRO/TABLIER: HUILE - TAPE CAMEL
- GREMBIULE AL CIOCCOLATO - CINTA ARENA/TABLIER EN CHOCOLAT - RUBAN SABLE

Grembiuli stampe

Tabliers imprimés



C/608 Grigio antracite
Gris anthracite



C/616 Rosso
Rouge



C/604 Albero



C/614 Pistachio
Pistache



C/607 Granato
Grenat



C/613 Turchese
Turquoise



RIF/REF. 158100 Gourmet
Unisex con tasca/Unisex avec poches
Taglia unica/Taille unique. 92x75 cm.
Twill/Serge 220 gr/m²
100%PES



c/5121 Kitchen



c/5128 Lollipop



c/5124 Wine



c/5122 Polaroid



c/5123 Vidrio



c/5125 Tropical



c/4112 Tattoo

RIF/REF. 159200
Unisex con tasca/Unisex avec poches
Taglia unica/Taille unique. 80x68 cm.
Twill/Serge 220 gr/m²
100%PES



c/5138 Country



c/5137 Biscuit



c/5136 Coffee

RIF/REF. 159100
 Unisex con tasca/Unisex avec poches
 Taglia unica/Taille unique. 47x74 cm.
 Twill/Serge 220 gr/m²
 100%PES



RIF/REF. 159300
 Unisex con tasca/Unisex avec poches
 Taglia unica/Taille unique. 35x60 cm.
 Twill/Serge 220 gr/m²
 100%PES



c/5124 Wine



c/5123 Vidrio/Glass



c/5135 Pizarra

Grembiule francese

Tablier français



c/101 c/112 c/001



c/104 c/103 c/108 c/111 c/105

RIF/REF. 118G00
Unisex senza tasca
Unisex sans poche
Taglia unica/Taille unique
100x100 cm.
Twill/Serge 200 gr/m²
65%PES 35%CO



c/101 c/112 c/001

Senza tasca
Sans poche



RIF/REF. 118000
Unisex con tasca
Unisex avec poche
Taglia unica/Taille unique
90x75 cm.
Twill/Serge 200 gr/m²
65%PES 35%CO

Con tasca
Avec poche

RIF/REF. 118B00
Unisex con tasca
Unisex avec poche
Taglia unica/Taille unique
90x75 cm.
Twill/Serge 200 gr/m²
65%PES 35%CO



c/105 c/104 c/103 c/108 c/101 c/112 c/001



c/101 c/112 c/001

RIF/REF. 118GB0
Unisex con tasca
Unisex avec poche
Taglia unica/Taille unique
100x100 cm.
Twill/Serge 200 gr/m²
65%PES 35%CO



Con apertura

Avec ouverture

RIF/REF. 191000

Unisex con tasca

Unisex avec poche

Taglia unica/Taille unique. 90x110 cm.

Twill/Serge 200 gr/m²

65%PES 35%CO



c/101 c/117 c/139 c/001 c/104 c/103 c/115 c/107 c/308 c/118 c/121 c/127



c/111 c/116 c/105 c/112 c/125 c/138 c/136 c/119 c/123 c/122 c/141 c/124



RIF/REF. 191200

Unisex con tasca

Unisex avec poche

Taglia unica/Taille unique. 90x110 cm.

Twill/Serge 200 gr/m²

100%PES

Twill 100% Poliestere
Serge 100% Polyester



c/617 c/607 c/618 c/001 c/608



C/117 C/136 C/121 C/105 C/115 C/116 C/103 C/112 C/119 C/123 C/104 C/107 C/124 C/111 C/118 C/127 C/108 C/122 C/001 C/101 C/125 C/139 C/141 C/138

Ampio colorato

Large coloré

65% Poliestere/Polyester
35% Cotone/Coton

RIF/REF. 120000
Unisex con tasca
Unisex avec poche
Taglia unica/Taille unique. 30X60 cm.
Twill/Serge 200 gr/m²
65%PES 35%CO



C/607 C/608 C/611 C/001 C/612 C/609 C/614 C/617 C/615 C/618 C/616 C/613

RIF/REF. 120600
Unisex con tasca
Unisex avec poche
Taglia unica/Taille unique. 30X60 cm.
Twill/Serge 200 gr/m²
65%PES 35%CO

RIF/REF. 182200
 Unisex con tasche
 Unisexe avec poches
 Taglia unica/Taille unique
 80x65 cm.
 Twill/Serge 200 gr/m²
 100%PES



RIF/REF. 182000
 Unisex con tasca
 Unisexe avec poche
 Taglia unica/Taille unique.
 80x65 cm.
 Twill/Serge 200 gr/m²
 65%PES 35%CO



RIF/REF. 182V00
 Unisex con tasche
 Unisexe avec poches
 Taglia unica/Taille unique 80x65 cm.
 Denim/Jean 260 gr/m²
 65%PES 35%CO 3%EA



65% Poliestere
35% Cotone

65% Polyester
35% Coton



c/101

RIF/REF. 116BC0

Unisex con tasca/Unisex avec poche
Taglia unica/Taille unique. 90x75 cm.
Twill/Serge 200 gr/m²
65%PES 35%CO



c/141 c/122 e/111 c/116 c/105 e/112 e/125



e/138 e/119 e/123 e/136 e/104 c/103 e/107 e/115



c/108 e/127 e/121 e/118 e/124 c/001 e/139 e/117

Con tasca
Avec poche



Sarga 100% Poliéster
Twill 100% Polyester

RIF/REF. 116100

Unisex con tasca/Unisex avec poche
Taglia unica/Taille unique. 90x75 cm.
Twill/Serge 220 gr/m²
100%PES



c/615 c/616 c/607 c/611 c/612 e/609 e/617 e/613 c/614 c/618 e/605 c/001

ca
oche

Grembiuli corti

Tabliers courts

65% Poliestere - 35% Cotone

65% Polyester - 35% Coton

RIF/REF. 11745B COLORE/COULEUR

Unisex con tasca/Unisex avec poche

Taglia unica/Taille unique. 50x75 cm.

Twill/Serge 200 gr/m²

65%PES 35%CO



RIF/REF. 117B00 BIANCO/BLANC

Unisex con tasca

Unisex avec poche

Taglia unica/Taille unique.

50x75 cm.

Twill/Serge 200 gr/m²

65%PES 35%CO

RIF/REF. 117100

Unisex con tasca/Unisex avec poche

Taglia unica/Taille unique. 90x75 cm.

Twill/Serge 220 gr/m²

100%PES



c/117 c/139 c/001 c/123 c/119 c/138 c/125 c/105 c/112 c/116 c/111



c/127 c/121 c/108 c/118 c/122 c/141 c/124 c/136 c/107 c/115 c/103 c/104



c/608 c/001 c/612 c/611 c/616 c/607



c/615 c/614 c/618 c/609 c/613 c/617



RIF/REF. 117000
 Unisex senza tasca
 Unisex sans poche
 Taglia unica/Taille unique
 30x75 cm.
 Twill/Serge 200 gr/m²
 65%PES 35%CO

Senza tasca.
Sans poche.



Grembiuli economico.
Tablier économique

RIF/REF. 120300
 Unisex con tasche e nastri di cotone
 Unisex avec poches et rubans de coton
 Talla única/One size: 30x60 cm.
 Sarga/Twill 200 gr/m²
 65%PES 35%CO



Senza tasca
Sans poche

RIF/REF. 116000
 Unisex senza tasca
 Unisex sans poche
 Taglia unica/Taille unique: 90x75 cm.
 Twill/Serge 200 gr/m²
 65%PES 35%CO



65% Poliestere

35% Cotone

65% Polyester - 35% Coton

Con nastri de cotone

Avec des rubans de coton

**Grebbiuli
economico.**

Tablier économique

RIF/REF. 116300 Unisex con tasca/Unisex avec poche

RIF/REF. 116400 Unisex con tasca/Unisex avec poche

Taglia unica/Taille unique. 90x75 cm.

Twill/Serge 200 gr/m²

65%PES 35%CO

c/112 c/001 c/101

c/112 c/001 c/101



RIF/REF. 180000

Unisex con tasca/Unisex avec poche

Taglia unica/Taille unique. 110x85 cm.

Twill/Serge 220 gr/m²

100%PES



c/607

c/001

c/606

RIF/REF. 181000

Unisex con tasca/Unisex avec poche

Taglia Unica/Taille unique. 68x68 cm.

Twill/Serge 220 gr/m²

100%PES



c/001

c/607

c/608

c/606



c/607

c/606

c/604

RIF/REF. 175100

Unisex con tasca/Unisex avec poche
 Taglia unica/Taille unique. 90x110 cm.
 Twill/Serge 220 gr/m²
 100%PES



c/749

RIF/REF. 175200

Unisex con tasca/Unisex avec poche
 Taglia unica/Taille unique. 90x110 cm.
 Twill/Serge 220 gr/m²
 100%PES



c/804

c/706

c/725

c/001

RIF/REF. 161000

Unisex con tasca/Unisex avec poche
 Taglia unica/Taille unique. 95x75 cm.
 Twill/Serge 200 gr/m²
 65%PES 35%CO





RIF/REF. 123100

Unisex con tasca/Unisex avec poche
 Taglia unica/Taille unique. 30x60 cm.
 Twill/Serge 200 gr/m²
 65%PES 35%CO



c/775

c/776



RIF/REF. 191100

Unisex con tasca/Unisex avec poche
 Taglia unica/Taille unique.
 90x105 cm.
 Denim lavato/Denim lavé 275 gr/m²
 100%CO

c/805 Denim lavato/Denim lavé

RIF/REF. 153300

Unisex con bolsillos
 with pockets
 Talla única / One size
 95x75 cm.
 Denim lavato/Denim lavé
 275 gr/m²
 100%CO

c/805 Denim lavato/Denim lavé



REF. 153700

Unisex con tasca
 Unisex avec poche
 Taglia unica/Taille unique.
 95x75 cm.
 Jeans non lavato
 Jeans non lavé
 275 gr/m²
 100%CO

c/805 Jeans non lavato/Jeans non lavé

Grembiule denim.
 Tablier denim

121



1. **RIF/REF. 111000**
 Donna/Femme
 Con tasche/avec poches
 Taglia unica/Taille unique
 80x54cm,
 Twill/Serge 200 gr/m²
 65%PES 35%CO

c/101 Bianco/Blanc

2. **RIF/REF. 107000**
 Donna/Femme
 Con tasche/avec poches
 Taglia unica/Taille unique
 80x54cm,
 Twill/Serge 200 gr/m²
 65%PES 35%CO

c/101 Bianco/Blanc

RIF/REF. 108000 VICHY/GINGHAM
 Donna/Femme
 Con tasche/avec poches
 Taglia unica/Taille unique. 80x54cm.
 Vichy 118 gr/m²
 65%PES 35%CO



c/202 c/203 c/204 c/205 c/206



c/207 c/208 c/209 c/212 c/213



RIF/REF. 108000
 Donna/Femme
 Con tasche/avec poches
 Taglia unica/Taille unique
 80x54cm.
 Twill/Serge 200 gr/m²
 65%PES 35%CO

c/101 Bianco/Blanc

RIF/REF. 123000

GREMBIULE RIGIDO

TABLIER RIGIDE

Unisex/Unisex

Taglia unica/Taille unique

110x85 cm.

Cordone regolabile

Cordon ajustable 100% PVC

c/101 Bianco/Blanc



RIF/REF. 115000

GREMBIULE SPUGNA

TABLIER TISSU ÉPONGE

RIF/REF. 115AT0

GREMBIULE SPUGNA

ALTA TEMPERATURA

TABLIER TISSU ÉPONGE

HAUTE TEMPERATURE

Unisex/Unisex

Taglia unica/Taille unique

90x75 cm.

SPUGNA/PVC/ÉPONGE/PVC

c/101 Bianco/Blanc



RIF/REF. 125000

GREMBIULE HULE

TABLIER HULE

Unisex /Unisex

Taglia unica/Taille unique

90x70 cm.

100% PP

290 gr/m²

c/101 Bianco/Blanc



RIF/REF. 126100

DELANTAL NITRILIO

NITRILE APRON

Unisex

Talla única/One size

115x90 cm.

Imbracatura regolabile

Harnais ajustable

Nitrile 600 gr/m²

c/101 Bianco/Blanc

Caratteristiche Nitrile

Alta resistenza ai grassi animali,

al sangue e alle alte temperature.

-Maggiore durata e flessibilità

Caractéristiques Nitrile

Haute résistance aux graisses animales, au sang et aux

températures élevées

Une plus grande durabilité et flexibilité





RIF/REF. 126200 ELASTOMERO/ELASTOMÈRE

Unisex/Unisex

Taglia unica/Taille unique. 115x85 cm.

450 gr/m²

Caratteristiche elastomero:

-Resistenza ai grassi animali, al sangue e ai normali prodotti per la pulizia.

-Alta flessibilità, gradevole da portare e facile da pulire.

Caracteristiques de l'elastomere

-Résistance aux graisses animales, au sang et aux produits de nettoyage normaux.

-Haute flexibilité, agréable à transporter et facile à nettoyer.

c/107 Azzurro/Bleu ciel

c/101 Bianco/Blanc



RIF/REF. 124000 SKAY

Unisex/Unisex

Taglia unica/Taille unique.

90x70 cm.

550 gr/m²

80%PVC - 20%CO

c/101 Bianco/Blanc



RIF/REF. 126300 VINILO

Unisex/Unisex

Taglia unica/Taille unique. 115x90 cm.

475 gr/m²

c/101 Bianco/Blanc

Caratteristiche vinilo:

-Protezione di base contro l'acqua.

-Ideale per hotel, ristoranti e servizi pubblici.

Caracteristiques vinilo:

-Protection de base contre l'eau.

-Idéal pour les hôtels, restaurants et services publics.





RIF/REF. 126400 ANDREW

Unisex/Unisex
 Taglia unica/Taille unique.
 115x90 cm
 355 gr/m²
 100% PU

Arnés regulable y ollados termosellados, no metálicos.

Adjustable harness and heat-sealed, non-metallic eyelets.



Colori disponibili/Couleurs disponibles:



RIF/REF. 126500 PETER

Unisex/Unisex
 Taglia unica/Taille unique.
 90x135 cm.
 230 gr/m²
 100% PU

Caratteristiche poliuretano:

**-Alta resistenza ai grassi animali e al sangue. Protegge dai rischi meccanici e offre resistenza alla penetrazione dell'acqua.
 -Finimenti regolabili e occhielli non metallici termosigillati**

Carateristiques du polyuréthane:

**+Haute résistance aux graisses animales et au sang. Il protège des risques mécaniques et offre une résistance à la pénétration de l'eau.
 +Jamais réglables et oeillets thermosoudés non métalliques**



Colori disponibili/Couleurs disponibles:



RIF/REF. 159700 GREMBIULE AECC HOPE

TABLIER AECC HOPE
 Unisex con tasca/avec poche
 Taglia unica/Taille unique. 80x68 cm.
 Strech 165 gr/m²
 100%PES

C/888

RIF/REF. 100028 GREMBIULE FARFOLLE NASTRO/TABLIER PAPILLONS LIEN

Unisex con tasca/avec poche
 Taglia unica/Taille unique. 80x68 cm.
 Strech 165 gr/m²
 100%PES

C/2993 Farfolle nastro/Papillons lien



RIF/REF. 100001
GREIMBULE/TARI IFRUnisex
Twill/Serge
Taglia unica/Taille unique
220 gr/m² 100%PES



**"Circondarsi di umorismo
è il modo migliore per
spaventare i fantasmi"**

**"S'envelopper d'humour est
le meilleur moyen d'effrayer
les fantômes"**

c/5141 Kukumenaje



KUKUXUMUSU
BY **gary's**



c/5143 Kukulobo



c/5144 Kukuvacas



c/115 Turchese/Turquoise



c/116 Arancia/Orange

RIF/REF. 111600 GREIMBULE CON PETTORINA
INFANTILE BIANCO

TABLIER SALOPETTE ENFANT BLANC

RIF/REF. 111600 GREIMBULE INFANTILE COLORE

TABLIER SALOPETTE ENFANT COULEUR

Twill/Serge: 200 gr/m²

65%PES 35%CO

TAGLIE/TAILLES: 4-8-12

MISURE: lungo x ampio / MESURES: large x long

T/S 4=50x40 cm.

T/S 8=65x50 cm.

T/S 12=80x60 cm.

Piccoli Grandi Chef

Les petits grands chefs



c/101 Bianco/Bianc



c/138 Lampione/ramboise



c/127 Pistacchio/Pistache

POCOYO
X GARY'S



RIF/REF. 111900
GREIMBULE POCOYO AMICI
TABLIER POCOYO AMIS

Taglie/ Tailles 4-8

Twill/Serge 220 gr/m²

100%PES

C/101 Bianco/Bianc

gary's
naturewear

www.garysworkwear.com/naturewear

**Per una moda
più sostenibile.**

Pour une mode plus sustainable

**La nostra linea usi ecologici
tessuti sostenibili come i cotone
organico e 100% poliestere riciclato**

*Notre ligne écologiques utilise des
tissus sustainable comme les cotons
bio e 100% polyester recyclé*

**RIF/REF. 158600 GREIMBULE CON PETTORINA
TABLIERE AVEC SALOPETTE**

Unisex con tasche/Unisex avec poches
Taglia unica/Taille unique: 91x74 cm
Loneta/Toile 310 gr/m²
100% COTONE BIOLOGICO/COTON BIO

**RIF/REF. 159500 GREIMBULE SENZA PETTORINA
TABLIERE SANS SALOPETTE**

Unisex con tasche/Unisex avec poches
Taglia unica/Taille unique: 46x58 cm
Loneta/Toile 310 gr/m²
100% COTONE BIOLOGICO/COTON BIO



RIF/REF. 157400 DELANTAL/APRON

Unisex con tasca/Unisex avec poche
Taglia unica/Taille unique: 76x92 cm
Loneta beige/Toile beige 211 gr/m²
Loneta grigio marengo/Toile gris marengo 250 gr/m²
100% COTONE BIOLOGICO/COTON BIO



c/110 Beige

c/128 Grigio antracite
Gris anthracite



c/5132 Nature

c/5133 Breathe



c/114 Marfil/Ivory



RIF/REF. 159600

Unisex con tasca
Unisex avec poche
Taglia unica/Taille unique:
80x68 cm.
Twill/Serge 205 gr/m²
100% POLIESTERE RICICLATO
POLYESTERE RECYCLE



RECYCLED
POLYESTER

c/5131 Preserve

c/5129 Life



c/109 Grigio/Gris

c/101 Bianco/Bianco

**RIF/REF. 159800 GREIMBULE CON PETTORINA
TABLIERE AVEC SALOPETTE**
Unisex con tasca/Unisex avec poche
Taglia unica/Taille unique: 91x74 cm.
Twill/Serge: 205 gr/m²
100% COTONE BIOLOGICO/COTON BIO



ORGANIC COTTON



c/156 Cenere/Cendre

c/152 Blu grigiastro/Bleu gris

c/114 Avorio/Ivoire

REF. 159900 DELANTAL SIN PETO / HALF APRON

Unisex con tasca/Unisex avec poche
Taglia unica/Taille unique: 42x72 cm.
Twill/Serge: 205 gr/m²
100% COTONE BIOLOGICO/COTON BIO



c/156 Cenere/Cendre

c/114 Avorio/Ivoire

c/152 Blu grigiastro/Bleu gris



c/101 Bianco/Bianco

c/109 Grigio/Gris



ORGANIC COTTON

DENIM

gary's

Gary's
DENIM
workwear

Creato per conquistare anche i più esigenti, in cui si uniscono l'essenza di uno stile naturale a modelli più ribelli, in una collezione urban e moderna.

Crée afin de séduire les plus exigeants, où l'essence du naturel rencontre les patrons plus rebelles, dans une collection urbaine et actuelle.

RIF/REF. 148500 NAMIB

Unisex con tasche/Unisex avec poches

Taglia unica/Taille unique, 38x65 cm.

Similpelle/Similicuir 460 gr/m²

65%PU 25%PES 10%CO

c/124 Marrone/Marron

c/139 Grigio antracite
Gris anthracite

RIF/REF. 155400 MONTE

Unisex con tasche/Unisex avec poches

Taglia unica/Taille unique, 74x67 cm.

Similpelle/Similicuir 460 gr/m²

65%PU 25%PES 10%CO

c/124 Marrone/Marron

c/139 Grigio antracite
Gris anthracite



RIF/REF. 148800 CHIHUAHUA
Unisex con tasche/Unisexe avec poches
Taglia unica/Taille unique. 40x65 cm.
100% Pelle/100% Cuir

c/001 Nero/Noir

c/147 Cioccolato/Chocolat

c/124 Marrone/Marron



RIF/REF. 155900 ARABIA
Unisex con tasca
Unisex avec poche
Taglia unica/Taille unique.
74x70 cm.
100% Pelle/100% Cuir

c/001 Nero/Noir

c/147 Cioccolato/Chocolat

c/124 Marrone/Marron





RIF/REF. 155300 TENERÉ
 Unisex con tasche/Unisex avec poches
 Taglia unica/Taille unique. 74x80 cm
 Jeans elastico/Jean elastique 260 gr/m²
 65%PES 32%CO 3%EA

c/821 Nero/Noir

c/826 Blu navy/Bleu marine



c/825 Grigio/Gris

c/823 Sabbia/Sable

c/824 Verde muschio/Vert mousse

c/822 Marrone/Marron



c/823 Sabbia/Sable

c/825 Grigio/Gris

c/821 Nero/Noir

c/826 Blu navy/Bleu marine



RIF/REF. 148100 SAHARA
 Unisex con tasche/Unisex avec poches
 Taglia unica/Taille unique. 30x55 cm
 Jeans elastico/Jean elastique 260 gr/m²
 65%PES 32%CO 3%EA

RIF/REF. 330500
 BRETELLE SEPARATE
 CEINTURE RÉGLABLE SÉPARÈMENT

SCEGLI LA TUA COMBINAZIONE
CHOISIS TA COMBINAISON
(P. 53)

c/824 Verde muschio/Vert mousse

c/822 Marrone/Marron



c/825 Grigio/Gris

c/824 Verde muschio/Vert mousse

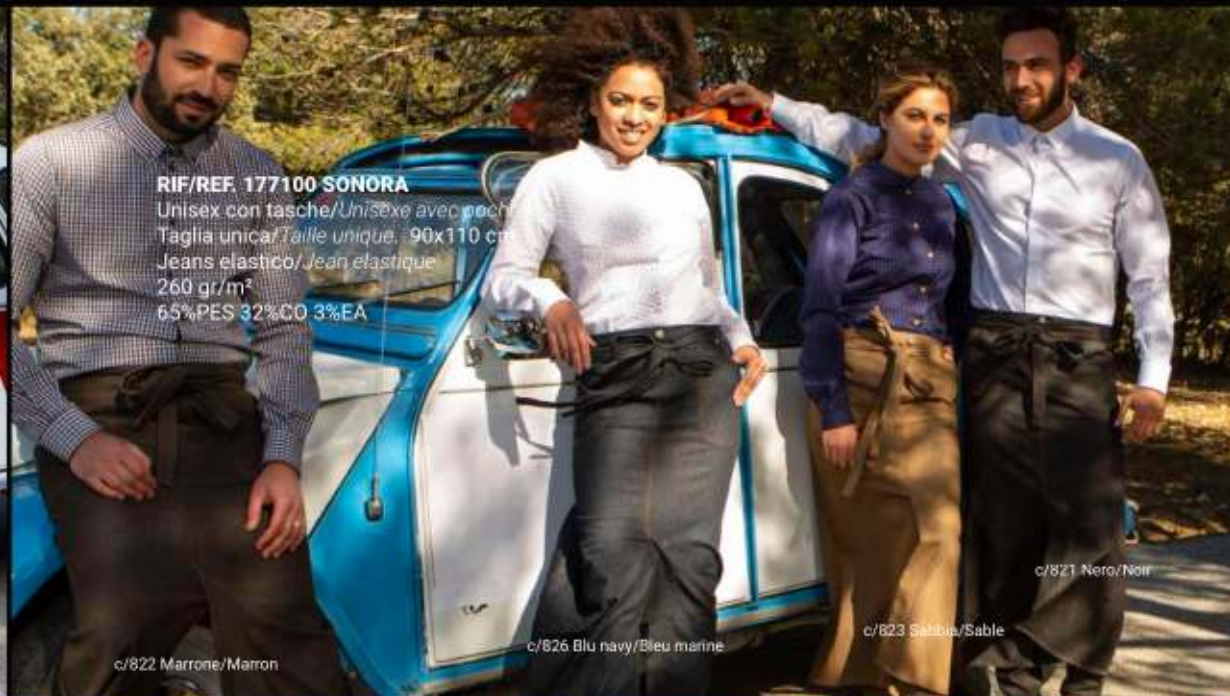

RIF/REF. 177100 SONORA

Unisex con tasche/Unisexe avec poche
Taglia unica/Taille unique: 90x110 cm
Jeans elastico/Jean elastique
260 gr/m²
65%PES 32%CO 3%EA

c/822 Marrone/Marron

c/826 Blu navy/Bleu marine

c/823 Sabbia/Sable

c/821 Nero/Noir



c/825 Grigio/Gris

c/826 Blu navy/Bleu marine

c/824 Verde muschio/Vert mousse

c/821 Nero/Noir



RIF/REF. 148300 JORDANIA

Unisex con tasche/Unisexe avec poches
Taglia unica/Taille unique: 50x68 cm
Jeans elastico/Jean elastique
260 gr/m²
65%PES 32%CO 3%EA

c/823 Sabbia/Sable

c/822 Marrone/Marron



c/825 Grigio/Gris

c/822 Marrone/Marron

c/821 Nero/Noir

c/823 Sabbia/Sable

RIF/REF. 155100 TABERNAS

Unisex con tasche/Unisex avec poches
 Taglia unica/Taille unique. 74x80 cm.
 Jeans elastico/Jean elastique
 260 gr/m²
 65% PES 32% CO 3% EA



c/824 Verde muschio/Vert mousse

c/826 Blu navy/Bleumarine

RIF/REF. 329500

BRETELLE SEPARATE
 CEINTURE REGABLE SEPARÉMENT
 (P. 53)



1. RIF/REF. 148700 LIBIA (CORTO)

Unisex con bolsillo/with pocket
 Talla única/One size. 38x64 cm.
 Juta/Toile de jute. 250 gr/m²
 100% PES

c/110 Beige

c/116 Arancia/Orange

2. RIF/REF. 155800 SIRIO (PETO)

Unisex con tasca/Unisex avec poche
 Taglia unica/Taille unique. 78x66 cm.
 Juta/Toile de jute. 250 gr/m²
 100% PES

c/110 Beige

c/116 Arancia/Orange

DENIM
 gary's



c/139 Grigio antracite/Gris marengo

c/116 Arancia/Orange

c/110 Beige

c/124 Marrone/Marron

RIF/REF. 177200 ATACAMA

Unisex con tasche/Unisexé avec poches
 Taglia unica/Taille unique. 89x92 cm.
 Juta/Toile de jute 250 gr/m²
 100%PES



c/139 Grigio antracite/Gris marengo

c/110 Beige

c/116 Arancia/Orange

c/124 Marrone/Marron

RIF/REF. 148400 SINAI

Unisex con tasche/Unisexé avec poches
 Taglia unica/Taille unique. 38x65 cm.
 Juta/Toile de jute 250 gr/m²
 100%PES



c/825 Grigio/Gris

c/823 Sabbia/Sable

c/822 Marrone/Marron

c/821 Nero/Noir



RIF/REF. 148200 DUBAI

Unisex con tasche/Unisexé avec poches
 Taglie P y G/Tailles S & L. 28x39 cm.
 Jeans elastico/Jean elastique. 260 gr/m²
 65%PES 32%CO 3%EA

c/826 Blu navy/Bleu marine

c/824 Verde muschio/Vert mousse



c/116 Arancia/Orange

c/139 Grigio antracite
Gris anthracite

c/822 Marrone/Marron

c/110 Beige

RIF/REF. 155200 GOBI

Unisex con tasche/Unisex avec poches
Taglia unica/Taille unique, 74x80 cm
Juta/Toile de juta 250 gr/m²
100%PES



RIF/REF. 155500 THAR

Unisex con tasche/Unisex avec poches
Taglia unica/Taille unique
72x80 cm.
Jeans/Jean 350 gr/m²
100%CO

c/139 Grigio antracite
Gris anthracite

c/110 Beige

c/116 Arancia/Orange



c/148 Indaco/Indigo

c/112 Bordeaux

c/001 Nero/Noir

RIF/REF. 148600 RYN

Unisex con tasche
Unisex avec poches
Taglia unica/Taille unique
33x56 cm.
Jeans/Jean 350 gr/m²
100%CO



RIF/REF. 155700 JUHA

Unisex con bolsillos/with pockets
Talla única/One size: 68x77 cm.
Denim lavato/Denim lave
350 gr/m²
100%CO

c/001 Nero/Noir

c/112 Bordeaux

c/148 Indaco/Indigo

RIF/REF. 155600 COLORADO
Unisex con tasche/Unisex avec poches
Taglia unica/Taille unique. 75x80 cm.
Jeans/Jean 350 gr/m²
100%CO



c/001 Nero/Noir

c/827 Blu/Bleu



Collezione/Collection
Grembiuli/Tabliers
Urban Design

RIF/REF. 100021

Unisex con tasche
Unisex avec poches
Taglia unica/Taille unique. 40x68 cm.
Ciniglia/Chenille
320 gr/m²
34%PES 33%CO 33%LINEN
Tto. Machie/Traitement anti-tâches

c/110 Beige



RIF/REF. 100019

Unisex con tasche
Unisex avec poches
Taglia unica/Taille unique. 82x72 cm.
Ciniglia/Chenille
320 gr/m²
34%PES 33%CO 33%LINEN
Tto. Machie/Traitement anti-tâches

c/110 Beige





1. **RIF/REF. 100008**
 Unisex con tasche
 Unisexe avec poches
 Taglia unica/Taille unique.
 82 x 72 cm
 Ciniglia/Chenille
 320 gr/m²
 34%PES 33%CO 33%LINEN
Tto. Machie/Traitment anti-tâches

c/110 Beige

2. **RIF/REF. 100013**
 Unisex con tasche
 Unisexe avec poches
 Taglia unica/Taille unique.
 50 x 68 cm
 Ciniglia/Chenille
 320 gr/m²
 34%PES 33%CO 33%LINEN
Tto. Machie/Traitment anti-tâches

c/110 Beige



1. **RIF/REF. 100022**
 Unisex con tasche
 Unisexe avec poches
 Taglia unica/Taille unique.
 80x68 cm
 Ciniglia/Chenille
 320 gr/m²
 34%PES 33%CO 33%LINEN
Tto. Machie/Traitment anti-tâches

c/110 Beige

2. **RIF/REF. 100023**
 Unisex con tasche
 Unisexe avec poches
 Taglia unica/Taille unique.
 35 x 67 cm
 Chenilla/Chenille
 320 gr/m²
 34%PES 33%CO 33%LINEN
Tto. Machie/Traitment anti-tâches

c/110 Beige



1. **RIF/REF. 100017**
 Unisex con tasche
 Unisexe avec poches
 Marmorizzato/Marbre
 Taglia unica/Taille unique.
 80x66 cm
 350 gr/m²
 71%PES 29%Acrylic

c/5145 Marmorizzato/Marbre

2. **RIF/REF. 100018**
 Unisex con tasche
 Unisexe avec poches
 Marmorizzato/Marbre
 Taglia unica/Taille unique.
 50x68 cm
 350 gr/m²
 71%PES 29%Acrylic

c/5145 Marmorizzato/Marbre



1. **RIF/REF. 100006**
 Unisex con tasche
 Unisexe avec poches
 Taglia unica/Taille unique.
 82x72 cm
 Ciniglia vigoré/Chenille vigoureuse
 256 gr/m²
 80%Acrylic Dralon 20%PES
Tto. Machie/Traitment anti-tâches

c/147 Cioccolato/Chocolat

2. **RIF/REF. 100012**
 Unisex con tasche
 Unisexe avec poches
 Taglia unica/Taille unique.
 58x74 cm
 Ciniglia vigoré/Chenille vigoureuse
 256 gr/m²
 80%Acrylic Dralon 20%PES
Tto. Machie/Traitment anti-tâches

c/147 Cioccolato/Chocolat



c/149 Verde kaki/Vert kaki

RIF/REF. 100016
Unisex con tasche
Unisex avec poches
Taglia unica/Taille unique.
40x68 cm.
Ciniglia/Chenille
320 gr/m²
54%PES 46%CO
Tto. Machie/Traitment
anti-tâches



c/128 Albero

c/001 Nero/Noir

Happier Workplaces



c/115 Turchese/Turquoise



RIF/REF. 100009
Unisex con tasche
Unisex avec poches
Taglia unica/Taille unique.
82x72 cm
Ciniglia/Chenille
320 gr/m²
54%PES 46%CO
Tto. Machie/Traitment
anti-tâches

c/001 Nero/Noir



c/149 Verde kaki/Vert kaki



c/128 Albero



c/115 Turchese/Turquoise



RIF/REF. 100007
Unisex con tasche
Unisex avec poches
Taglia unica/Taille unique
82x72 cm
Ciniglia/Chenille
320 gr/m² 54%PES 46%CO
Tto. Machie/Traitement anti-tâches

c/001 Nero/Noir



REF. 100005
Unisex con tasche
Unisex avec poches
Taglia unica/Taille unique
82x72cm
Ciniglia/Chenille
320 gr/m² 54%PES 46%CO
Tto. Machie/Traitement anti-tâches

c/109 Grigio/Gris



RIF/REF. 100011
Unisex con tasche
Unisex avec poches
Taglia unica/Taille unique
50x68 cm
Ciniglia/Chenille
320 gr/m² 54%PES 46%CO
Tto. Machie/Traitement anti-tâches

c/109 Grigio/Gris



c/128 Albano



RIF/REF. 100014
Unisex con tasche
Unisex avec poches
Taglia unica/Taille unique. 80x68 cm
Ciniglia/Chenille
320 gr/m²
54%PES 46%CO
Tto. Machie/Traitment anti-tâches

c/109 Grigio/Gris



c/149 Verde kaki/Vert kaki



c/105 Rosso/Rouge



c/139 Grigio antracite/Gris marengo



RIF/REF. 100015
Unisex con tasche
Unisex avec poches
Taglia unica/Taille unique
35x67 cm
Ciniglia/Chenille
320 gr/m²
54%PES 46%CO
Tto. Machie/Traitment anti-tâches





RIF/REF. 161300

Unisex con tasche

Unisex avec poches

Taglia unica/Taille unique

90x75 cm

Denim lavato/Denim délavé

350 gr/m²

27%PES 73%CO

c/836 Indaco/Indigo



RIF/REF. 149400

Unisex con tasche

Unisex avec poches

Taglia unica/Taille unique

40x69 cm

Denim lavato/Denim délavé

350 gr/m²

27%PES 73%CO

c/836 Indaco/Indigo

RIF/REF. 161400

Unisex con tasche

Unisex avec poches

Taglia unica/Taille unique

80x82 cm

Jean indossati e lavati

Denim usé et délavé

350 gr/m²

27%PES 73%CO

c/836 Indaco/Indigo



RIF/REF. 149300

Unisex con tasche

Unisex avec poches

Taglia unica/Taille unique

40x69 cm

Jean indossati e lavati

Denim usé et délavé

350 gr/m²

27%PES 73%CO

c/836 Indaco/Indigo

RIF/REF. 161600

Unisex con tasche

Unisex avec poches

Taglia unica/Taille unique

85 x 80 cm

Denim lavato/Denim délavé

350 gr/m²

27%PES 73%CO

c/836 Indaco/Indigo

RIF/REF. 149500

Unisex con tasche

Unisex avec poches

Taglia unica/Taille unique

40 x 69 cm

Denim lavato/Denim délavé

350 gr/m²

27%PES 73%CO

c/836 Indaco/Indigo



RIF/REF. 149200
 Unisex con tasche
 Unisex avec poches
 Taglia unica/Taille unique
 40x69 cm
 Tela/Toile 340 gr/m²
 100% CO

C/121 Verde Oliva/Vert Olive
 C/128 Albero

RIF/REF. 161200
 Unisex con tasche
 Unisex avec poches
 Taglia unica/Taille unique
 80x85 cm
 Tela/Toile 340 gr/m²
 100% CO

C/128 Albero
 C/121 Verde Oliva/Vert olive



PROTEZIONE DEL COLLO

PROTECTEUR DE COU



C/001 Nero/Noir

C/110 Beige

C/124 Marrone/Marron

RIF/REF. 330900
 Taglia unica/Taille unique
 Neoprene/Néoprène
 390 gr/m²
 95% PES 5% EA



Accessori
Accessoires

Piccoli cuochi

Petit cuisiniers

RIF/REF. 445100 CAPELLO CHEF BIANCO/CHAPEAU CHEF BLANC
 RIF/REF. 4453000 CAPELLO CHEF COLORI/CHAPEAU CHEF COULURS
 Taglie/Tailles 6/12
 Twill/Serge 200gr/m²
 65%PES 35%VCO

C/115 Turchese
Turquoise



C/116 Arancia
Orange



C/138 Lampone/Framboise



C/927 Pistacchio/Pistache

C/101 Bianco/Blanc



RIF/REF. 445200 CAPELLO CHEF POCOYO
 CHAPEAUX CHEF POCOYO
 Taglia/Taille 6
 Twill/Serge 220gr/m²
 100%PES
 c/101 Bianco/Blanc



RIF/REF. 450100 GRANDE CAPELLO CHEF
CHAPEAU GRAN CHEF
Unisex/Unisex. Taglia unica/Taille unique
Twill/Serge 180gr/m²
50%POLIESTERE RICICLATO
POLYESTER RECICLÉ
50%COTONE BIOLOGICO
COTON BIO



C/142 Sabbia/Sable



C/117 Grigio perla/Gris perle



C/101 Bianco/Blanc

RIF/REF. 449700 gatsby cap
CHAPEAU GATSBY

Unisex/Unisex. Taglia unica/Taille unique
211gr/m² Loneta beige/Toile beige
250 gr/m² Loneta grigio antracite/Toile gris marengo
100%COTONE BIOLOGICO/BIO COTON



C/110 Loneta beige/Toile beige

C/139 Loneta grigio antracite/Toile gris marengo

RIF/REF. 441500
CHAPELLO DA PIRAT/CHAPEAU PIRATE
Unisex. Taglia unica/Taille unique
Twill/Serge 180gr/m²
50%POLIESTERE RICICLATO
POLYESTER RECICLÉ
50%COTONE BIOLOGICO
COTON BIO

RIF/REF. 441700 GORRO PIRATA/PIRATE HAT
Unisex/Unisex. Taglia unica/Taille unique
Twill/Serge 145gr/m² Microfibra/Microfibre
50%POLIESTERE RICICLATO
POLYESTER RECICLÉ



C/101 Bianco/Blanc



C/001 Nero/Noir

RIF/REF. 448400
Unisex/Unisex
Taglie/Tailles 54-62
100%Nylon



C/001 Nero/Noir



C/101 Bianco/Blanc

RIF/REF. 450300
Unisex/Unisex
Taglie P/M/Tailles S/M
116gr/m² Popeline
65%PES 35%CO

Velcro



C/001 Nero/Noir

RIF/REF. 447500 SIROS
Unisex/Unisex
Taglie M/G/Tailles M/L
200gr/m² Twill/Serge
65%PES 35%CO



C/001 Nero/Noir



C/101 Bianco/Blanc



C/101 Bianco/Blanc



C/104 Marino/Marin

RIF/REF. 448600 CAPELLO CON PROFILATURA
CHAPEAU REBETTE
Regolabile con velcro
Réglable avec velcro
Unisex/Unisex
Taglia unica/Taille unique
200gr/m² Twill/Serge
65%PES 35%CO



C/112 Bourdeaux



C/001 Nero/Noir





C/4112 Tattoo



C/4115 Berenjenas



C/4114 Militar



C/4111 Tapiz



C/5111 Carpas



C/4104 Huevos fritos



C/5114 Sabor



C/5127 Cleaver



C/5115 Ecuación



C/5117 Llamas



C/5118 Mezclum



C/5113 Iconos



C/5112 Gambas



C/4113 Araña gris



C/4116 Coco



C/5121 Kitchen



C/5116 Fogón

Capella grande chef.

Chapeau gran chef

RIF/REF. 448900
Unisex/Unisex
Taglia unica/Taille unique
Regolabile con velcro
Règlable avec velcro
220gr/m² Twill/Serge
100%PES



RIF/REF. 449300
Unisex/Unisex
Taglia unica/Taille unique
Regolabile con velcro
Règlable avec velcro
165gr/m² Vichy Bambula
65%CO 35%PES

c/266 Nero/Noir

RIF/REF. 448800
Unisex/Unisex
Taglia unica/Taille unique
Regolabile con velcro/Règlable avec velcro
210gr/m² Sarga/Twill
100%CO



C/5107 Maderas



C/5108 Catrina



C/5103 Camuflaje



C/5119 Vegetales



C/5101 Olivas



C/5102 Guindillas



RIF/REF. 447V00
Unisex/Unisex
Taglia unica/Taille unique
Regolabile con velcro
Règlable avec velcro
118gr/m² Vichy
65%CO 35%PES

c/202 Cuadro marino
Navy gingham



RIF/REF. 446V00
Unisex/Unisex
Taglia unica/Taille unique
Regolabile con velcro
Règlable avec velcro
200gr/m² Vichy
65%CO 35%PES

c/101/202



RIF/REF. 449200 DENIM/TEJANO
Unisex/Unisex
Taglia unica/Taille unique
Regolabile con velcro
Règlable avec velcro
200gr/m² Denim lavato/Denim délavé
100%CO

c/805 Denim lavato/Denim délavé

RIF/REF. 4481V0
 TWILL/Serge
 Unisex/Unisex
 Taglia unica/Taille unique
 Regolabile con velcro
 Réglable avec velcro
 200gr/m² Sarga/Twill
 65%PES 35%CO



C/123 Lilla/Lilas



C/119 Malva/Mauve



C/125 Fucsia/Fuchsia



C/124 Marrone/Marron



C/112 Bordeaux



C/105 Rosso/Rouge



C/116 Arancio/Orange



C/118 Bottiglia verde
Bouteille vert



C/127 Pistacchio/Pistache



C/115 Turchese/Turquoise



C/103 Azzurro/Bleu



C/001 Nero/Noir



C/139 Grigio antracite
Gris anthracite



C/117 Grigio perla/Gris perle



C/141 Crema/Creme



C/138 Lampone/Framboise



C/121 Verde oliva/Verte olive



C/104 Blu navy/Bleu marine



C/136 Viola/Violet



c/706 Riga nero
Ligne noir



c/776 Cuadro nero/grigio
Cadre noir gris



c/738 Riga grigio
Ligne gris



c/749 Riga grigio fine
Ligne gris fine



c/775 Stampa galles
Imprimé galles



c/804 Denim/Jean

RIF/REF. 4482V0
 Unisex.
 Talla única/One size
 Regulable con velcro
 Adjustable with velcro
 Tejido según color
 Fabric depending on colour



c/725 Riga pistacchio
Ligne pistache



RIF/EF. 445V00 TWILL BIANCO
 SERGE BLANC
 Unisex/Unisex. Taglia unica/Taille unique
 Regolabile con velcro/Réglable avec velcro
 200gr/m² Twill/Serge
 65%PES 35%CO

c/101 Bianco/Blanc

Capello de pirata Chapeau de pirate

Microfibra estampata/Microfibre imprimé

RIF/REF. 441200
Unisex/Unisex. Taglia unica/Taille unique
148 gr/m² Microfibra/Microfibre
100%PES



C/5111 Carpas C/5118 Mezclum C/5116 Fogón C/4112 Tattoo



C/5127 Cleaver C/5121 Kitchen C/5113 Iconos C/5115 Ecuación



C/4115 Berenjenas C/4116 Coco C/4114 Sabor C/4113 Araña gris



C/5112 Gambas C/5117 Llamas C/4114 Militar C/4104 Huevos fritos C/4111 Tapiz

RIF/REF. 441100
Unisex/Unisex. Taglia unica/Taille unique
210 gr/m² Twill/Serge
100%PES



C/5108 Catrinas C/5102 Guindillas C/5119 Vegetales C/5101 Olivas C/5107 Madera C/5103 Camuflaje



aerosilver

RIF/REF. 447900
AEROSILVER
Unisex/Unisex
Taglia unica/Taille unique
140gr/m² AeroSilver
100%PES



RIF/REF. 447800
AEROSILVER
Unisex/Unisex
Taglia unica/Taille unique
200gr/m²
Denim lavato
Denim délavé
100%PES



Grande colorato in capelli in microfibra

Grand coloré en chapeaux de microfibre

RIF/REF. 441800
Unisex/Unisex.
Taglia unica/Taille unique
148 gr/m²
Microfibra/Microfibre
100%PES



C/001 Nero/Noir C/101 Bianco/Bianc C/104 Blu navy/Bleu marine C/105 Rosso/Rouge C/107 Cielo blu/Bleu ciel



C/108 Vert/Verde C/112 Bordeaux C/115 Turchese/Turquoise C/119 Malva/Mauve C/127 Pistacchio/Pistache



RIF/REF. 441400
Unisex/Unisex.
Taglia unica/Taille unique
148 gr/m²
Chambray rombi
Chambray losange
70%CO 30%PES

c/Grigio antracite
Gris anthracite



C/138 Lampono/ramboise C/142 Sabbia/Sable C/139 Grigio antracite
Gris anthracite

RIF/REF. 447100
Unisex/Unisex
Taglia unica/Taille unique
Tessuto in base al colore
Tissu selon la couleur



C/775 Stampa galles
Imprimé galles

C/202 Cuadro marino
Quadriillé marine

C/749 Riga grigio fine
Ligne gris fine

C/706 Riga nero
Ligne noir

C/127 Pistacchio
Pistache

C/738 Riga grigio
Ligne gris

C/725 Riga pistacchio
Ligne pistache

C/101 Bianco
Blanc

C/117 Grigio perla
Gris perle



C/139 Grigio antracite
Gris anthracite



C/121 Verde oliva
Olive verte



C/804 Denim
Jean



C/141 Crema
Crém



C/124 Marrone
Marron



C/001 Nero
Noir



C/112 Bordeaux



C/105 Rosso/Pauze



C/116 Arancia
Orange



C/103 Azzurro
Bleu



C/136 Morado
Violet



C/123 Lila
Lilac



C/119 Malva
Purple



C/138 Lampone
Framboise



C/125 Fucsia
Fuchsia



C/115 Turchese
Turquoise



C/104 Blu navy
Bleu marine

Bandana aerosilver

RIF/REF. 200100
Bandana stampata
Bandana imprimée
Unisex/Unisex
Taglia unica/Taille unique
140gr/m² Aerosilver
100%PES



C/4112 Tattoo

C/4113 Araña gns

C/4114 Militar

C/4115 Berenjenas



C/5111 Carpas

C/5118 Mezclum

C/5116 Fogón

C/5112 Gambas

C/5117 Llamas

C/4116 Coco

C/5127 Cleaver

C/5121 Kitchen

C/5113 Iconos

C/5115 Ecuación

C/5114 Sabor



C/4104 Huevos fritos

C/4111 Tapiz

aerosilver

RIF/REF. 200200
Bandana liscio
Bandana lisse
Unisex.
Talla única/One size
140gr/m² Aerosilver
100%PES



C/127

C/105

C/115

C/139

C/001

C/101



RIF/REF. 400001
 CAPELLO DA PIRATA
 CHAPEAUX DE PIRATE
 Unisex
 MICROFIBRA/MICROFIBRE
 148 gr/m² 100%PES
 Taglia unica/Taille unique

C/5142 Kukuovejas
 C/5141 Kukumenaje
 C/5144 Kukuvacas



RIF/REF. 400001
 CAPELLO CHEF
 CHAPEAU CHEF
 Unisex
 TWILL/SERGE
 220 gr/m² 100%PES
 Taglia unica/Taille unique

C/5142 Kukuovejas
 C/5141 Kukumenaje
 C/5144 Kukuvacas



RIF/REF. 220001
 BANDANA
 Unisex/Unisex
 AEROSILVER
 140 gr/m² 100%PES
 Taglia unica/Taille unique

C/5142 Kukuovejas
 C/5141 Kukumenaje
 C/5144 Kukuvacas





RIF/REF. 415000
GRIGLIA PACK 10
EN MAILLE PACK 10
Unisex/Unisex
Taglia unica/Taille unique
65%PES 35%CO

C/115 Turchese/Turquoise c/104 Blu navy/Bleu marine



C/108 Verde/Vert



C/001 Nero/Noir



C/105 Rosso/Rouge



C/112 Bordeaux



C/107 Cielo blu/Bleu ciel



C/103 Azzurro/Bleu



C/124 Marrone/Marron



C/125 Fucsia/Fuchsia



C/119 Malva/Mauve



C/111 Giallo/Jaune



C/106 Rosa/Rose



C/127 Pistacchio/Pistache



C/116 Arancia/Orange



C/123 Lilla/Lilas



C/202 Cuadro marino
Quadrillé marin

Capelli *Chapeaux*

10 PACK

RIF/REF. 416000
GRIGLIA COLORE PACK 10/GRILLE COULEUR PACK 10
Unisex/Unisex. Taglia unica/Taille unique
65%PES 35%CO



C/108 Verde/Vert



C/115 Turchese/Turquoise



C/105 Rosso/Rouge



C/127 Pistacchio/Pistache



c/104 Blu navy/Bleu marine



C/001 Nero/Noir

RIF/REF. 440000
CON PROFILATURA PACK 6
ÉCOSSAISE PACK 6
Unisex/Unisex
Taglie/Tailles P-M-G-SG
65%PES 35%CO



C/101/105 Rosso/Rouge



C/101/112 Bordeaux



C/101/104 Blu navy/Bleu marine



C/101/001 Nero/Noir



C/103 Azzurro/Bleu



C/001 Nero/Noir



C/108 Verde/Vert



C/105 Rosso/Rouge



C/112 Bordeaux

RIF/REF. 435000
PACK 6
Unisex/Unisex
Taglie/Tailles P-M-G-SG
65%PES 35%CO

RIF/REF. 449100
CON PROFILATURA PACK 6
ÉCOSSAISE PACK 6
Unisex/Unisex
Taglie/Tailles P-M-G-SG
65%PES 35%CO



C/001 Nero/Noir



C/112 Bordeaux

RIF/REF. 405100
PACK 10 COPRIRE LA NUCA
PACK 10 COUVERTURE DE NUQUE
Unisex
Talla única/One size
65%PES 35%CO



c/104 Blu navy/Bleu marine



C/101 Bianco/Blanc

RIF/REF. 420000
PACK 10
Unisex/Unisex
Taglia unica/Taille unique
65%PES 35%CO
116 g/m² Popeline



C/101 Bianco/Blanc

RIF/REF. 421000
PACK 10
Unisex/Unisex
Taglia unica/Taille unique
65%PES 35%CO
116 g/m² Popeline



C/001 Nero/Noir

RIF/REF. 422000
PACK 10
Unisex/Unisex
Taglia unica/Taille unique
65%PES 35%CO



C/101 Bianco/Blanc



C/001 Nero/Noir

RIF/REF. 410000 10 PACK
RIF/REF. 410100 MAXI 10 PACK
Unisex/Unisex
Taglia unica/Taille unique
65%PES 35%CO



C/101 Giglia Bianco
Maille Blanc



RIF/REF. 400000 6 PACK
Unisex/Unisex
Taglie/Tailles P-M-G-SG
65%PES 35%CO

C/101 Bianco/Blanc



RIF/REF. 401000 6 PACK
Gomma posteriore
Gomme arrière
Unisex/Unisex
Taglia unica/Taille unique
65%PES 35%CO

C/101 Bianco/Blanc



RIF/REF. 446200 PACK
PACK 10 CAPELLO GRIGLIA
CASQUETTE EN MAILLE
Unisex/Unisex
Taglia unica/Taille unique
100%PES

C/101 Bianco/Blanc



RIF/REF. 405000 10 PACK
Unisex/Unisex
Taglia unica/Taille unique
Elástico detrás/Elastic back
65%PES 35%CO

C/101 Bianco/Blanc

RIF/REF. 446100 PACK 6 CON CANALÉ
PACK 6 AVEC CÔTELE
Unisex/Unisex
Taglia unica/Taille unique
100%PES



C/101 Blanco/White

C/001 Negro/Black



C/124 Marrone/Marron



C/139 Grigio antracite/Gris anthracite



C/116 Arancia/Orange



C/110 Beige

RIF/REF. 459900
Capello/Casquette
Unisex/Unisex
Taglia unica/Taille unique
Juta/Toile de jute
250 gr/m²
100%PES



C/822 Marrone/Marron



C/825 Grigio/Gris



C/826 Blu navy/Bleu marine

RIF/REF. 459700
Capello/Casquette
Unisex/Unisex
Jean elastic/Jean élastique
260 gr/m²
65%PES 32%CO 3%EA



C/824 Verde muschio/Vert mousse



C/821 Nero/Noir



C/823 Sabbia/Sable

DENIM
garys

RIF/REF. 459800
Capello/Casquette
Unisex/Unisex
Taglia unica/Taille unique
Jean elastic/Jean élastique
260 gr/m²
65%PES 32%CO 3%EA



C/139 Gris marengo/Dark grey



C/124 Marrone/Brown



RIF/REF. 330500
STRICIA DI SPIGA
RUBAN À CHEVRONS
30mm
Unisex/Unisex
Taglia unica/Taille unique



RIF/REF. 329400
SPALLINA ELASTICA SUSPENSORIO ELASTICO
BRETTELLE ELASTIQUE LONGUE
30mm
Taglia unica/Taille unique



RIF/REF. 329500
ESPALLINA ELASTICA PER PETTORINA
BRETTELLE ÉLASTIQUE COURTE
30mm
Taglia unica/Taille unique

DENIM
garys

Cinture

Ceintures

RIF/REF. 330100
CINTURA SPORT UOMO PELE
CEINTURE SPORT HOMME CUIR
Taglie/Tailles 90-95-100-110
c/124 Marrone/Marron



RIF/REF. 330200
CINTURA UOMO PELE
CEINTURE HOMME CUIR
Taglie/Tailles
90-95-100-110
c/001 Nero/Noir



RIF/REF. 330800
CINTURA DONA PELE
CEINTURE FEMME CUIR
Taglie/Tailles 80-85-90-95
c/001 Nero/Noir
c/104 Blu navy/Bleu marine
c/124 Marrone/Marron



RIF/REF. 330700
CINTURA UOMO PELE
CEINTURE HOMME CUIR
Taglie/Tailles 90-95-100-110
c/104 Blu navy/Bleu marine
c/124 Marrone/Marron



gary's

Sartoria

RIF/REF. 330300
CINTURA UOMO PELE
REVERSIBILE
CEINTURE HOMME CUIR
REVERSIBLE
Taglie/Tailles
90-95-100-110
c/001 Nero-Marrone
Noir-Marron



RIF/REF. 330400
CINTURA UOMO
SIMILPELE
CEINTURE HOMME
SIMILI CUIR
Taglie/Tailles
90-95-100-110
c/001 Nero-Noir



Bretelle stampate-Tinta unita-Pelle

Bretelles imprimées-Unies-En cuir

RIF/REF. 329100
BRETELLE STAMPATE
BRETelles IMPRIMÉES
35mm. Unisex/Unisex
Taglia unica/Taille unique



c/620 Arabe bordeaux
Paisley bordeaux

c/129 Nido d'ape
Nid d'abeille

c/104 Triangolo blu navy
Triangles bleu marine

c/112 Righe bordeaux
Rayures bordeaux

c/117 Rombi grigio
Losanges gris



RIF/REF. 329300 BRETELLE TINTA UNITA
BRETELLE UNIES
20mm.
Similpelle/Similcui
Unisex/Unisex
Taglia unica/Taille unique

c/124 Marrone/Marron

RIF/REF. 329000
BRETELLE TINTA UNITA
BRETelles UNIES
30mm. Unisex/Unisex
Taglia unica/Taille unique



c/110 Beige

c/105 Rosso
Rouge

c/001 Nero
Noir

c/118 Verde bottiglia
Vert bouteille

c/112 Bordeaux

c/109 Grigio
Gris

c/101 Bianco
Blanc

c/104 Blu navy
Bleu marine

c/124 Marrone
Marron



RIF/REF. 327600
Cravatta Jacquard
Stretta (5cm)
Cravate Jacquard
Pan Étroit
Unisex/Unisex
Taglia unica/Taille unique



c/119 Malva/Mauve

c/104 Blu navy/Bleu marine

RIF/REF. 327400
Cravatta Raso
Stretta (5cm)
Cravate Satin
Pan Étroit
Unisex/Unisex
Taglia unica/Taille unique



c/001 Nero/Noir

c/112 Bordeaux

c/104 Blu navy/Bleu marine

RIF/REF. 327500
Cravatta Jacquard
Ojo de Perdiz
Stretta (5cm)
Cravate Jacquard
(Oeil-de-perdrix)
Pan Étroit
Unisex/Unisex
Taglia unica/Taille unique



c/117 Grigio perla/Gris perla

c/104 Blu navy/Bleu marine

gary's *Sartoria*

Cravatte *Cravates* | 55

RIF/REF. 327300
 Cravatta Puntini
 Stretta (5cm)
 Cravate Pois
 Pan Étroit
 Unisex/Unisex



c/105 Rosso/Rouge

c/107 Azzurro/Bleu ciel

c/104 Blu navy/Bleu marine

RIF/REF. 322000
 Cravatta Raso
 Nodo fisso
 Chiusura clip (7cm)
 Cravate similicuir
 Nœud fixe
 Fermeture par clip
 Unisex/Unisex



c/112 Bordeaux

c/001 Nero/Noir

c/104 Marino/Navy blue

RIF/REF. 327200
 Cravatta disegni
 Stretta (5cm)
 Cravate dessins
 Pan Étroit
 Unisex/Unisex



c/104 Blu navy teschi/Bleu marine Têtes de mort

c/109 Grigio bicicletta/Gris vélos

c/103 Blu chiaro auto/Bleuâtre voitures

RIF/REF. 327100
 Cravatta Jacquard
 Stretta
 Nodo fisso
 Chiusura clip (5cm)
 Cravate Ç Jacquard
 Pan Étroit
 Nœud fixe
 Fermeture par clip
 Unisex/Unisex



c/139 Grigio antracite/Gris anthracite

c/112 Bordeaux

c/103 Blu chiaro/Bleuâtre

RIF/REF. 326300
 Cravatta Skay
 Nodo fisso
 Chiusura clip (5cm)
 Cravate Skay
 Nœud fixe
 Fermeture par clip
 Unisex/Unisex



c/001 Nero/Noir

RIF/REF. 323000
 Cravattino Perla
 Nodo fisso
 Chiusura clip (5cm)
 Cravate courte Perle
 Nœud fixe
 Fermeture par clip
 Unisex/Unisex



c/001 Nero/Noir

c/104 Blu navy/Bleu marine

c/139 Grigio antracite
 Gris anthracite

c/112 Bordeaux



c/821 Jeans nero/Denim noir



c/822 Jeans marrone/Denim marron



c/832 Jeans sabbia/Denim sable



c/824 Jeans verde muschio/Denim vert mousse



c/825 Jeans grigio/Denim gris



c/826 Jeans blu/Denim bleu



c/001 Nero/Noir



c/117 Grigio perla/Gris perla



c/112 Bordeaux



c/127 Verde/Vert



c/103 Blu chiaro/Bleuâtre



c/104 Blu navy/Bleu marine

RIF/REF. 326800 Cravatta Jeans

Nodo fisso

Chiusura clip (6cm)

Cravate denim

Nœud fixe

Fermeture par clip

Unisex/Unisexé

Taglia unica/Taille unique

RIF/REF. 326200 Cravatta Jacquard

Occhio di Pernice (7cm)

Cravate Jacquard *Eil-de-perdrix*

Unisex/Unisexé

Taglia unica/Taille unique

RIF/REF. 326100
 Cravatta Jacquard
 a righe (7cm)
 Cravate Jacquard
 Rayures
 Unisex/Unisex
 Taglia unica
 Taille unique



c/123 Lilla Lilas
 c/112 Bordeaux
 c/117 Grigio perla Gris perla
 c/107 Blu chiaro Bleu ciel
 c/104 Blu navy Bleu marine
 c/119 Malva Mauve

RIF/REF. 326600
 Cravatta Juta
 Nodo fisso
 Chiusura clip (5cm)
 Cravate de la toile
 Nœud fixe
 Fermeture par clip
 Unisex/Unisex
 Taglia unica
 Taille unique



c/110 Beige
 c/124 Marrone Marron
 c/116 Arancia Orange
 c/139 Gris Marengo Dark grey

RIF/REF. 321000
 Cravatta Raso
 Cravate Satin
 (7cm)
 Unisex/Unisex
 Taglia unica
 Taille unique



c/104
 c/103
 c/118
 c/127
 c/136
 c/116
 c/105
 c/112
 c/138
 c/001
 c/139
 c/117
 c/124
 c/110

Papillon *Nœuds papillon*

RIF/REF. 326700
Papillon Jeans
Chiusura clip
Nœud papillon denim
Fermeture à clip
Unisex/Unisex
Taglia unica
Taille unique



c/821 Jeans nero
Denim noir



c/822 Jeans marrone
Denim marron



c/823 Jeans sabbia
Denim sable



c/824 Jeans verde muschio
Denim vert mousse



c/825 Jeans grigio
Denim gris



c/826 Jeans blu navy
Denim bleu marine

RIF/REF. 326900
Fiocco di Raso
Nodo fisso
Chiusura clip
Nœud en satin
Nœud fixe
Fermeture par clip
Unisex/Unisex
Taglia unica
Taille unique



RIF/REF. 326500
Papillon Juta
Occhio di pernice
Chiusura clip
Nœud papillon
œil de perdrix
Fermeture à clip
Unisex/Unisex
Taglia unica/Taille unique



c/139 Grigio antracite
Gris anthracite



c/124 Marrone
Marron



c/110 Beige



c/116 Arancia
Orange



c/129 Osso
os



c/001 Nero
Noir



c/104 Blu navy
Bleu marine



c/112 Bordeaux



c/001

c/139

c/127

c/118

c/136

c/103

c/104

c/138

c/112

c/116

c/105

c/105

c/110

RIF/REF. 324000
Papillon
Chiusura clip
Nœud papillon
Fermeture par clip
Unisex/Unisex
Taglia unica
Taille unique



c/117

gary's *Sartoria*



c/5129 Vegetales/Vegetables

Confezione da 3.
Pack 3

RIF/REF. 310100
Strofinacci
Torchons
Twill/Serge 210gr/m²
100%CO



c/5109 Menu

TOVAGLIOLO PER CAMERIERE
SERVIETTE POUR SERVEUR

RIF/REF. 470000
70X40cm
100%CO

Confezione da 6 ●
Pack 6



C/101

C/104

RRIF/EF. 120020
ZOCCO PELLE
CLOG EN CUIR

Unisex/Unisex
Taglie/Tailles 36-45

REF. 325000
CRAVATTA CON VELCRO
CRAVATE AVEC VELCRO
Unisex/Unisex

Taglia unica/Taille unique
Raso/Satin



C/123

C/119

C/116

C/112

C/115

C/127

C/122

C/124

C/001

Pack 6.

REF. 460000 FOULARD COLORATO
FOULARD COLORÉ

REF. 450000 FOULARD BIANCO
FOULARD BLANC

Unisex/Unisex

Taglia unica/Taille unique 67X67X97cm
Popelin 65%PES 35%CO

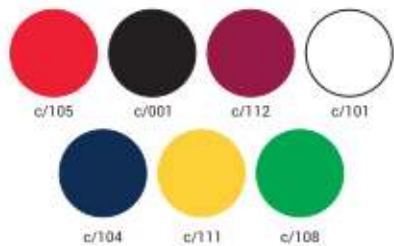

REF. 350100

FODERA PDA
ETUI PDA

Unisex/Unisex

Taglia unica/Taille unique





RIF/REF. 461400
 Foulard
 Chiffon vaporoso
 Puntini
 Foulard
 Mouseline vaporeuse
 À pois
 60x60 cm
 Quadrato/Carré



c/103 Blu chiaro/Bleuâtre

c/104 Blu navy/Bleu marine

c/105 Rosso/Rouge

RIF/REF. 461200
 Foulard
 Chiffon vaporoso
 Foulard
 Mouseline vaporeuse
 145x60 m
 Rettangolare
 Rectangulaire

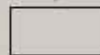

RIF/REF. 461300
 Foulard
 Chiffon vaporoso
 Foulard
 Mouseline vaporeuse
 70x70 m
 Quadrato/Carré



c/117

c/001

c/143

c/103

c/104

c/138

c/105

c/112

Foulard *Foulards*

L'azienda

Il continuo impegno per l'innovazione e la qualità (sia nel servizio che nei materiali) ha mantenuto l'azienda in costante sviluppo alla ricerca dell'eccellenza, ottenendo così materie prime di alto livello nelle mani di uno straordinario team di persone impegnate nell'azienda.

Nel 2019, dopo essere diventata leader del settore a livello nazionale e aver intrattenuto per anni relazioni commerciali al di fuori della Spagna, l'azienda ha iniziato a internazionalizzarsi su larga scala. La nostra missione è progettare e produrre abbigliamento da lavoro professionale, offrendo un ottimo servizio e un'ampia gamma di prodotti per i lavoratori più esigenti.

Gary's è il principale riferimento nella moda professionale, sia a livello nazionale che internazionale. Fornisce differenziazione in termini di design, comfort, protezione e durata a tutti i lavoratori che indossano i suoi capi.

L'azienda si proietta nel futuro preservando i valori della propria identità. L'ECCELLENZA NEL LAVORO È L'ESSENZA DI UNI-FORMES GARY'S, ATTRAVERSO I VALORI CHE LA GUIDANO: INTEGRITÀ, QUALITÀ, INNOVAZIONE, VICINANZA E PASSIONE.

Siamo una scommessa sicura per tutti i professionisti che vogliono vestirsi in modo comodo, moderno e sicuro al lavoro, tutti i giorni.

Notre entreprise

Notre engagement constant en faveur de l'amélioration et de la qualité (de nos services comme des matériaux que nous choisissons), a conduit notre entreprise à se développer de façon continue dans le but d'atteindre l'excellence. Notre extraordinaire équipe, engagée ainsi à nos côtés, donne vie à des matières premières de haute qualité.

En 2019, après être devenus les leaders de notre secteur au niveau national, et après avoir développé des relations commerciales au-delà des frontières espagnoles, nous avons amorcé l'internationalisation de notre entreprise à grande échelle. Nous nous donnons pour mission de créer et confectionner des uniformes tout en proposant un excellent service et un large catalogue de produits pour les professionnels les plus exigeants.

Gary's est la référence en matière de mode professionnelle, sur la scène nationale autant que sur la scène internationale. Le design, le confort, la protection et la durabilité : voilà tout ce qui distingue les professionnels qui font le choix de porter nos créations.

Aujourd'hui, notre entreprise se concentre sur l'avenir en n'oubliant jamais les valeurs qui fondent son identité.

L'EXCELLENCE PROFESSIONNELLE CONSTITUE L'ESSENCE MÊME DES UNIFORMES GARY'S. UN ENGAGEMENT PORTÉ PAR DES VALEURS : L'INTÉGRITÉ, LA QUALITÉ, L'INNOVATION, LA PROXIMITÉ ET LA PASSION.

Nous sommes une valeur sûre pour tous les professionnels qui souhaitent porter des uniformes confortables et modernes sur leur lieu de travail.

Ricami di più

Broderies personnalisées

Vuoi personalizzare i tuoi capi con un ricamo? Possiamo ricamare qualsiasi tipo di abbigliamento da lavoro. Grazie ai nostri macchinari all'avanguardia e al nostro team specializzato, puoi ricamare il tuo logo o frasi con alta qualità.

Vous songez à personnaliser votre tenue avec une broderie ? Nous brodons tous types d'uniformes professionnels. Grâce à du matériel dernière génération et à notre équipe d'experts, vous pourrez faire broder votre logo ou une phrase. Le tout, avec qualité.

Scorpi di più

Pour en savoir plus

Consulta i nostri cataloghi, puoi trovare tantissime collezioni per ogni settore.

Consultez notre catalogue. Vous y retrouverez toutes nos collections. Il y en a une pour chaque secteur

Seguici sui social

Suivez-nous sur les réseaux sociaux



garysworkwear.com



gary's Happier
Workplaces



8429935488394

© Uniformes Gary's

La riproduzione totale o parziale di questo catalogo, così come il suo trattamento in qualsiasi forma e con qualsiasi mezzo, è vietata senza l'espressa autorizzazione scritta della società titolare del copyright.

Toute reproduction totale ou partielle de ce catalogue, comme sa modification sous quelque forme ou par quelques moyens que ce soit est strictement interdite sans autorisation préalable et écrite de l'entreprise titulaire des droits d'auteur.

garys WORKWEAR



**Settore sanitario, alimentare e delle pulizie
e Lavoro**

garysworkwear.com

Happier Workplaces

Vi presentiamo la nostra nuova collezione di abbigliamento per il settore sanitario, professionale, alimentare e delle pulizie.

Grazie alla nostra esperienza e professionalità, sappiamo come deve essere una divisa. Per questo i nostri modelli offrono la massima comodità, resa e funzionalità, oltre a disegni innovativi e tessuti di ultima generazione. La nostra scommessa è proprio la microfibra elasticizzata con certificato antibatterico, che consente a chi la indossa di muoversi in ogni momento a 360 gradi.

La qualità dei nostri tessuti è la nostra scommessa sicura. L'innovazione dei disegni e delle stampe il nostro impegno quotidiano.

Settore sanitario
Settore delle pulizie
Settore alimentare
e Lavoro



RIF.	PAG.	RIF.	PAG.	RIF.	PAG.
100100	153	445800	167	604000	141
102500	149	445900	167	605000	136
102600	149	446100	219	607200	125
102700	153	446200	219	607300	124
102800	151	447300	162/167	607400	119
102900	151	447400	162/167	607700	130
103100	150	447600	166	608200	119
103200	150	447700	166	608300	207
103300	152	449100	218	609300	192
115000	210	449500	219	609600	86/88
121300	169	449600	219	609900	199
123000	211	450700	156	610100	119
124000	211	450800	158	610200	124
125000	210	450900	158	610300	130
126100	213	486000	210	611300	160
126200	212	486200	210	611400	21-30
126300	213	486300	156	611500	159
126400	215	520000	190	611700	51-53
126500	214	521000	189	611800	47-49
159700	163	522000	193	612300	112
160100	159	530000	128	612500	91
202100	209	531000	128	612600	93
203800	178	532000	203	612900	67
204000	178	534000	123	613100	112
212300	163	540000	131	613200	55
212900	204	541000	132	613900	69
213100	202	542000	134	614000	144
357100	133	542100	134	614100	109
370100	163	543000	132	614800	163
400000	219	550000	222	615200	33
401000	219	556000	147	615400	116
405000	219	558000	200	615500	93
405100	218	561200	187	615600	91
408000	219	570000	131	615700	115
410000	217	570100	206	615800	102
410100	217	570200	206	615900	101
415000	216	571000	128	616100	105
416000	217	575000	223	616200	106
420000	217	583600	161	616300	70
421000	217	585000	220	616500	40/41
422000	217	595100	155	616600	43
435000	218	595200	156	616700	56
440000	218	599100	51-53	616800	38
445400	161	600100	161	616900	97
445500	161	601000	139	617100	77
445600	167	602000	141	617200	83
445700	167	603000	139	617300	120

RIF.	PAG.	RIF.	PAG.
617500	10	661800	45
617600	111	661900	120
617700	17	662100	14
617800	60	662200	18
617900	126	662300	111
618100	121	662400	60
618200	121	662500	62
623500	142	662600	201
623600	143	662700	199
647000	194	662800	126
648000	196	700500	185
650000	127	700600	172
652000	195	700800	207
655100	92	702400	173
655200	90	702500	179
656200	112	702600	177
656400	112	702700	178
656500	55	702800	176
657200	146	702900	181
657300	66	703100	185
657400	109	703600	49
657500	108	703700	176
658100	69	703800	179
658400	34	704200	178
658500	116	704300	107
658600	43	704400	177
658700	56	704500	181
658800	38	704600	180
658900	115	704700	174
659400	92	704800	175
659500	90	704900	177
659600	7	750100	227
659700	102	750200	225
659800	101	772000	185
659900	104	772500	173
660500	40/41	773000	184
660600	106	773300	184
660700	37	840000	138
660800	71	841100	138
660900	78	841500	154
661100	74	842000	141
661200	82	843000	138
661300	83	844000	141
661400	97	845100	155
661500	123	115ATO	210
661600	65	772G00	139/182
661700	122	7733G0	183
		773G00	182

garysworkwear.com



MICROFIBRA 360

by **gary's** WORKWEAR

con trattamento

SILVADUR™

The Science of Intelligent Freshness

- SILVADUR™ 930 FLEX ANTIBATTERICO
- Con ioni d'argento
- Dona protezione e una freschezza



AJUSTE 360°



ANTIBACTERIANO



TRANSPIRABLE



CUIDADO FÁCIL

TESSUTO rivoluzionario

Assorbe e mantiene lontano il sudore dalla pelle, favorendo la traspirazione e l'evaporazione dell'umidità per una maggiore freschezza.

Grazie alla sua elasticità, che permette al capo di tendersi in tutti i sensi, dona la massima comodità al lavoratore.



A man with dark curly hair, wearing teal scrubs and white sneakers, is sitting on a ledge. He is looking off to the side with a thoughtful expression, resting his chin on his hand. The background shows a modern building with large windows and some greenery.

Settore sanitario



c/001 Nero



c/123 Lilla



c/152 Blu grigiastro



c/128 Senape



c/103 Blu



c/133 Corallo



c/101 Bianco



c/108 Verde



c/145 Verde petrolio

c/106 Rosa



c/136 Viola



c/155 Verde acqua



MICROFIBRA 360

con trattamento

SILVADUR™

The Science of Intelligent Freshness

RIF. 659600 Rosalia
Donna
MICROFIBRA 360 - 170g/m²
95% PES 5% EA
Taglie: XS-YL



A man and a woman are captured in mid-air, jumping joyfully in front of a glass door. The man, on the left, is wearing a purple scrub suit and has his arms raised in a 'V' shape. The woman, on the right, is wearing a light blue scrub suit and has her arms outstretched. Both are smiling broadly. The background is a dark, modern building with large glass panels. The lighting is bright, suggesting a sunny day.

senti
il movimento

MICROFIBRA 360
by **gary's** WORKWEAR



MICROFIBRA 360

con trattamento
SILVADUR™
The Science of Intelligent Freshness

RIF. 617500 Tadeo
Uomo
MICROFIBRA 360 - 170 g/m²
95% PES 5% EA
Taglie: XS-YL



c/001 Nero



c/123 Lilla



c/128 Senape



c/106 Rosa



c/133 Corallo



c/136 Viola



c/152 Blu grigiastro



c/108 Verde



c/155 Verde acqua



c/103 Blu



c/101 Bianco



c/145 Verde petrolio



garysworkwear.com



MICROFIBRA 360
by **gary's** WORKWEAR

con trattamento
SILVADUR.
The Science of Intelligent Freshness



AJUSTE 360°



ANTIBACTERIANO



TRANSPIRABLE



CUIDADO FÁCIL



Bluse.



c/128 Senape



c/106 Rosa



c/152 Blu grigiastro

RIF. 662100 Susan
Donna
MICROFIBRA 360 - 170 g/m²
95% PES 5% EA
XS-YL



c/136 Viola



c/133 Corallo

c/001 Nero



c/152 Blu grigiastro



c/128 Senape



U
MICE

RIF. 617700 Gari
Unisex
MICROFIBRA 360 - 170 g/m²
95% PES 5% EA
XSS-YL

c/133 Corallo

c/101 Bianco

nisex.

ROFIBRA 360



MICROFIBRA 360

RIF. 662200 Yanira
Donna
MICROFIBRA 360 - 170 g/m²
95% PES 5% EA
XS-YL

c/145 Verde petrolio

c/123 Lilla

c/133 Corallo



Scopri
**la nostra
collezione
di
stampe.**



BLUSE STAMPATE

Print rinnovati

Usiamo tecniche innovative per la stampa digitale su supporti tessili, per ottenere risultati duraturi e flessibili, con linee e texture naturali.

MICROFIBRA

È composta per la maggior parte da poliestere e poliammide.

- Antibatterico
- Altamente traspirante
- Non è necessaria la stiratura
- Non si alterano né i colori né i disegni
- Si asciuga molto velocemente
- Lavabile a 90 °C
- Repellente ai capelli e ai peli di animali domestici

Unisex.

c/2874 Imparare



c/2876 Fonendoscopio



RIF. 611400 Ada
Unisex
MICROFIBRA 148 g/m²
100% PES
XSS-YL

RIF. 611400 Ada
Unisex
MICROFIBRA 148 g/m²
100% PES
XSS-YL



c/2877 Sorriso



c/2889 Incisivo



RIF. 611400 Ada
Unisex
MICROFIBRA 148 g/m²
100% PES
XSS-YL

c/2881 Molari



RIF. 611400 Ada
Unisex
MICROFIBRA 148 g/m²
100% PES
XSS-YL

c/2887 Foglie

RIF. 611400 Ada
Unisex
MICROFIBRA 148 g/m²
100% PES
XSS-YL



c/2886 Fiore arcobaleno



c/2888 Rami

RIF. 611400 Ada
Unisex
MICROFIBRA 148 g/m²
100% PES
XSS-YL



RIF. 611400 Ada
Unisex
MICROFIBRA 148 g/m²
100% PES
XSS-YL

c/2879 Cats



RIF. 611400 Ada
Unisex
MICROFIBRA 148 g/m²
100% PES
XSS-YL

c/2883 Zoo



RIF. 611400 Ada
Unisex
MICROFIBRA 148 g/m²
100% PES
XSS-YL

c/2878 Woof



RIF. 611400 Ada
Unisex
MICROFIBRA 148 g/m²
100% PES
XSS-YL



c/2882 Stelle



c/2884 Cuore





RIF. 615200 Amaia
Unisex
MICROFIBRA 148 g/m²
100% PES
XSS-YL



c/2892 Bambini



c/2893 Worry

RIF. 658400 Zaida
Donna
MICROFIBRA 148 g/m²
100% PES
XS-YL

c/119 Malva



c/139 Grigio antracite





Health and care

Comfort Zone





c/001 Nero

c/101 Bianco

RIF. 660700 Olga
Donna
MICROFIBRA 148 g/m²
100% PES
XS-YL





RIF. 658800 Erica
Donna
MICROFIBRA 148 g/m²
100% PES
XS-YL

c/104 Navy

COOLMAX



RIF. 616800 Ander
Uomo
MICROFIBRA 148 g/m²
100% PES
XS-YL

c/104 Navy

COOLMAX

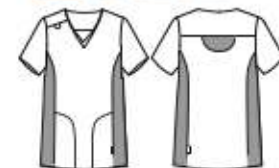



RIF. 660500 Gala
Donna
MICROFIBRA 148 g/m²
100% PES
XS-YL

c/001 Nero

RIF. 616500 Ferrán
Uomo
MICROFIBRA 148 g/m²
100% PES
XS-YL

c/001 Nero



RIF. 660500 Gala
Donna
MICROFIBRA 148 g/m²
100% PES
XS-YL

c/101 Bianco

RIF. 616500 Ferrán
Uomo
MICROFIBRA 148 g/m²
100% PES
XS-YL

c/101 Bianco





RIF. 658600 Gloria
Donna
MICROFIBRA 148 g/m²
100% PES
XS-YL

c/101 Bianco

RIF. 616600 Eloy
Uomo
MICROFIBRA 148 g/m²
100% PES
XS-YL

c/101 Bianco

gary's WORKWEAR



COMODITÀ
DISEGNO
RESA
FUNZIONALITÀ



RIF. 661800 Arancha
Donna
MICROFIBRA 148 g/m²
100% PES
XS-YL



c/119 Malva



c/139 Grigio antracite



c/101 Bianco

gary's **naturewear**

Per una moda più sostenibile.

La nostra linea ecologica utilizza tessuti sostenibili, come il poliestere 100% riciclato.

www.garysworkwear.com/naturewear

RIF. 611800 Eider
Unisex
MICROFIBRA 145 g/m²
100% POLIESTERE RICICLATO
XSS-YL



c/2895 Fucus



c/2896 Germogli



RIF. 611800 Eider
Unisex
MICROFIBRA 145 g/m²
100% POLIESTERE RICICLATO
XSS-YL

c/2894 Corteccia



RECYCLED
POLYESTER

LOVE
YOUR
PLANET.

*SCEGLIERE
la sostenibilità
indossando quotidiana-
mente capi sostenibili si-
gnifica contribuire un po'
di più alla tutela dell'am-
biente.*

RIF. 611 800 Eider
Unisex
MICROFIBRA 145 g/m²
100% POLIESTERE RICICLATO
XSS-YL

c/ 2897 Save



RIF. 703600 Pantaloni
Unisex
MICROFIBRA 145 g/m²
100% POLIESTERE RICICLATO
Taglie: XS-YL

c/101 Bianco



c/001 Nero





KUKUXUMUSU[®]
BY **gary's**

garysworkwear.com

RIF. 599100 Kukuxumusu
Unisex
MICROFIBRA 148 g/m²
100% PES
XSS-YL

c/2891 Kukutori

RIF. 611700 Kukuxumusu
Unisex
MICROFIBRA 148 g/m²
100% PES
XSS-YL

c/2891 Kukutori



RIF. 611700 Kukuxumusu
Unisex
MICROFIBRA 148 g/m²
100% PES
XSS-YL

c/2899 Kukucuori



RIF. 599100 Kukuxumusu
Unisex
MICROFIBRA 148 g/m²
100% PES
XSS-YL

c/2899 Kukucuori





RIF. 599100 Kukuxumusu
Unisex
MICROFIBRA 148 g/m²
100% PES
XSS-YL

c/2898 Kukumedici



RIF. 611700 Kukuxumusu
Unisex
MICROFIBRA 148 g/m²
100% PES
XSS-YL

c/2898 Kukumedici



MICROFIBRA ELASTIK

- Un mix perfetto di microfibra e fibre di elasthan
- Massima libertà di movimento
- Antibatterico
- Altamente traspirante
- Non è necessaria la stiratura
- Non si alterano né i colori né i disegni
- Repellente ai capelli e ai peli di animali domestici
- Si asciuga molto velocemente
- Lavabile a 90 °C



garys WORKWEAR



RIF. 613200 Héctor
Uomo
MICROFIBRA ELASTIK 155 g/m²
99% PES 1% EA
XS-YL

c/101 Bianco

c/001 Nero

RIF. 656500 Ágata
Donna
MICROFIBRA ELASTIK 155 g/m²
99% PES 1% EA
XS-YL

c/001 Nero

c/101 Bianco



RIF. 616700 Aitor
Uomo
MICROFIBRA ELASTIK 155 g/m²
99% PES 1% EA
XS-YL

c/127 Pistacchio

aerosilver



RIF. 658700 Leonor
Donna
MICROFIBRA ELASTIK 155 g/m²
99% PES 1% EA
XS-YL

c/127 Pistacchio

aerosilver



Microfibra Elastik.





MICROFIBRA 360

VIGORÉ

Tessuto screziato, utilizzato solitamente con fibre di diversi colori, per far sì che il capo non sia totalmente uniforme, ma sia dotato di sfumature delicate o più forti. Questo tipo di tessuto dona al capo carattere, creando un look simile a quello del lino, e crea effetti particolari e belli da vedere.

Il tessuto è fresco e la tela traspirante, perfetta per i capi più leggeri. Le sue linee sono morbide ed è molto comodo.

- Elevata durabilità
- Alta traspirabilità
- Tatto morbido
- Elasticità



AJUSTE 360°



TRANSPIRABLE



CUIDADO FÁCIL

Assorbe e mantiene lontano il sudore dalla pelle, favorendo la traspirazione e l'evaporazione dell'umidità per una maggiore freschezza.

Grazie alla sua elasticità, che permette al capo di tendersi in tutti i sensi, dona la massima comodità al lavoratore.





RIF. 617800 Fidel
Uomo
MICROFIBRA 360 - 170 g/m²
95% PES 5% EA
XS-YL

 aerosilver



RIF. 662400 Leticia
Donna
MICROFIBRA 360 - 170 g/m²
95% PES 5% EA
XS-YL

 aerosilver



Tutti i colori disponibili da uomo e da donna

c/119 Malva





c/117 Grigio perla

c/139 Grigio antracite

c/149 Verde cachi

Piccoli dettagli che fanno LA DIFFERENZA

c/128 Senape

RIF. 662500 Cris
Donna
MICROFIBRA 148 g/m²
100% PES
XS-YL



c/106 Rosa



c/155 Verde acqua



RIF. 661600 Amaya
Donna
MICROFIBRA 148 g/m²
100% PES
XS-YL

c/001 Nero



c/101 Bianco



RIF. 657300 Nuria
Donna
MICROFIBRA ELASTIK 155 g/m²
99% PES 1% EA
XS-YL

c/101/117 Bianco/Grigio perla



c/001/101 Nero/Bianco

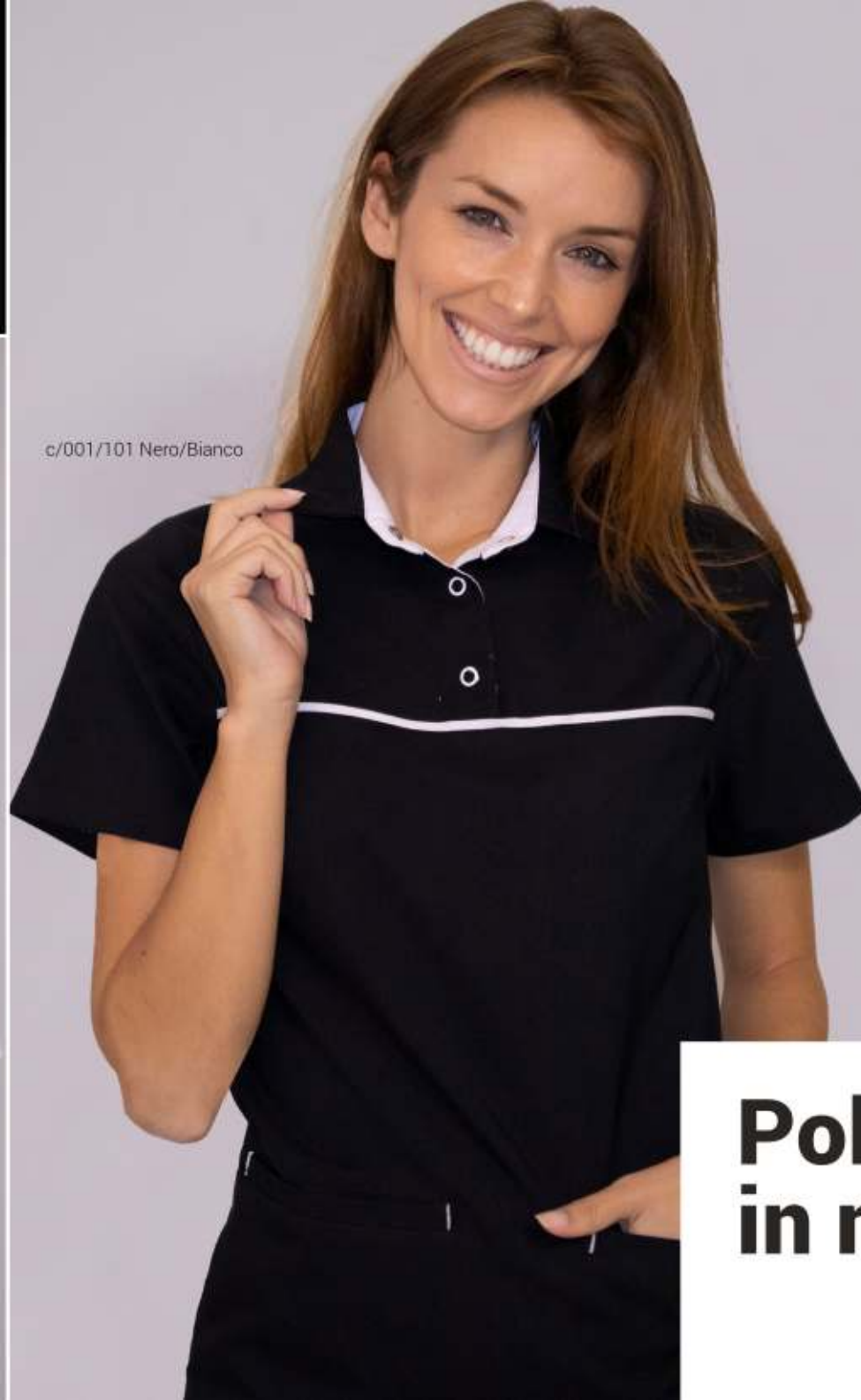

c/101/104 Bianco/Navv



Polo
in microfibra
SLIM FIT

c/101/117 Bianco/Grigio perla



c/001/101 Nero/Bianco



RIF. 612900 Javier
Uomo
MICROFIBRA ELASTIK 155 g/m²
99% PES 1% EA
XS-YL

c/101/104 Bianco/Navy





**Giacche
in microfibra**



RIF. 613900 Aarón
Uomo
MICROFIBRA 148 g/m²
100% PES
XS-YL

c/101 Bianco

RIF. 658100 Katia
Donna
MICROFIBRA 148 g/m²
100% PES
XS-YL

c/101 Bianco



c/139 Grigio antracite

RIF. 616300 Gorka
Uomo
MICROFIBRA 148 g/m²
100% PES
XS-YL

 aerosilver



c/127 Pistacchio



c/127 Pistacchio



RIF. 660800 Leyre
Donna
MICROFIBRA 148 g/m²
100% PES
XS-YL

 aerosilver

c/139 Grigio antracite





Una dichiarazione
DI DESIGN E COMODITÀ

gary's WORKWEAR

RIF. 661100 Nora
Donna
MICROFIBRA 148 g/m²
100% PES
XS-YL

c/139 Grigio antracite

c/127 Pistacchio

Camici in microfibra



 aerosilver



RIF. 617100 Julien
Uomo
MICROFIBRA 148 g/m²
100% PES
XS-YL

 aerosilver

c/139 Grigio antracite

c/127 Pistacchio

RIF. 660900 Victoria
Donna
MICROFIBRA 148 g/m²
100% PES
XS-YL

c/101 Bianco

c/001 Nero









All white

RIF. 661200 Priscila
Donna
MICROFIBRA 148 g/m²
100% PES
XS-YL

c/101 Bianco





**Elastico regolabile
sull'avambraccio**

RIF. 617200 Saúl
Uomo
MICROFIBRA 148 g/m²
100% PES
XS-YL

c/101 Bianco

Camici in microfibra



RIF. 661300 Tania
Donna
MICROFIBRA 148 g/m²
100% PES
XS-YL

c/101 Bianco

gary's WORKWEAR

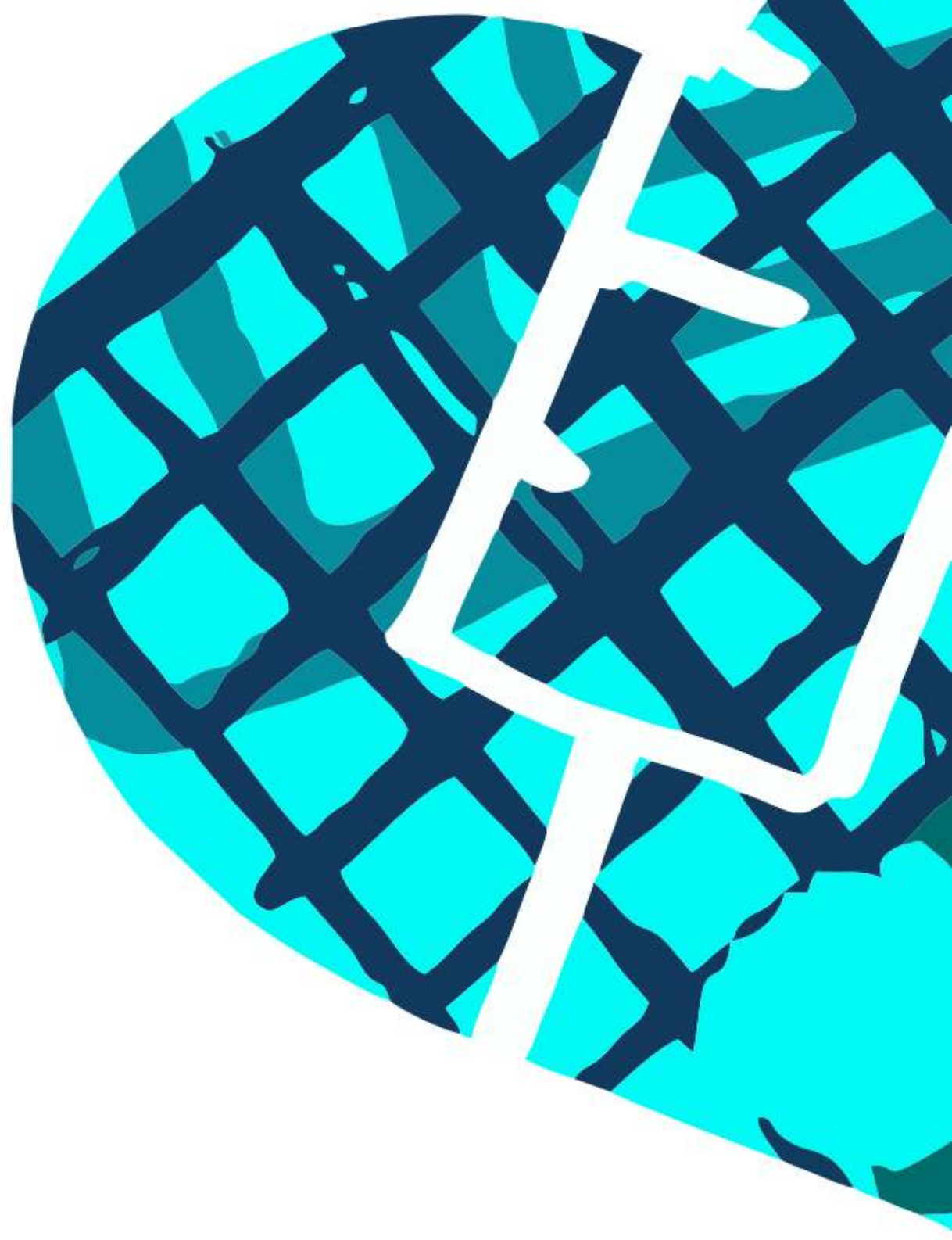



Full
color



c/105 Rosso



c/108 Verde



c/127 Pistacchio



c/101 Bianco



c/138 Lampone

Microfibra 100% Poliestere

Vasta gamma di colori.

RIF. 609600 Nerea
Unisex
MICROFIBRA 148 g/m²
100% PES
XSS-YL



c/112 Bordeaux

c/001 Nero



c/107 Azzurro



c/104 Navy

c/119 Malva



c/142 Sabbia



Tutti i colori disponibili da uomo e da donna

c/139 Grigio antracite



c/115 Turchese



RIF. 609600 Nerea
Unisex
MICROFIBRA 148 g/m²
100% PES

Plus sizes 2YL-3YL-4YL-5YL

c/101 Bianco - c/001 Nero



gary's WORKWEAR





c/101 Bianco



c/119 Malva



c/139 Grigio antracite

**Micro
100%**

**Tutti i co
da uo
a manic**



c/127 Pistacchio



c/138 Lampone

RIF. 655200 Elena
MANICA CORTA
Donna
MICROFIBRA 148 g/m²
100% PES
XS-YL

RIF. 659500 Begoña
MANICA LUNGA
Donna
MICROFIBRA 148 g/m²
100% PES
XS-YL

c/001 Nero



c/104 Navy



fibra Poliestere

colori disponibili uomo e da donna manica corta e lunga

RIF. 612500 Hugo

MANICA CORTA

Uomo

MICROFIBRA 148 g/m²

100% PES

XS-YL

RIF. 615600 Fabián

MANICA LUNGA

Uomo

MICROFIBRA 148 g/m²

100% PES

XS-YL



c/112 Bordeaux

c/115 Turchese





c/127 Pistacchio



c/119 Malva



c/112 Bordeaux

**Micro
100%**

**Tutti i colori
da uomo
a manica c**



c/138 Lampone



c/139 Grigio antracite



c/107 Azzurro

RIF. 655100 Sonia
MANICA CORTA
Donna
MICROFIBRA 148 g/m²
100% PES
XS-YL

RIF. 659400 Aitana
MANICA LUNGA
Donna
MICROFIBRA 148 g/m²
100% PES
XS-YL

fibra Poliestere



c/115 Turchese



c/142 Sabbia



c/001 Nero

**i disponibili
e da donna
orta e lunga**

RIF. 612600 Pablo
MANICA CORTA
Uomo
MICROFIBRA 148 g/m²
100% PES
XS-YL

RIF. 615500 Néstor
MANICA LUNGA
Uomo
MICROFIBRA 148 g/m²
100% PES
XS-YL



c/101 Bianco



c/104 Navy





CARATTERISTICHE DELL'EXTRAFIBER

- Alto rapporto leggerezza-resistenza
- Elevata durabilità
- Alta traspirabilità
- Protezione antistrappo
- Tatto morbido
- Elasticità



BIELASTICO

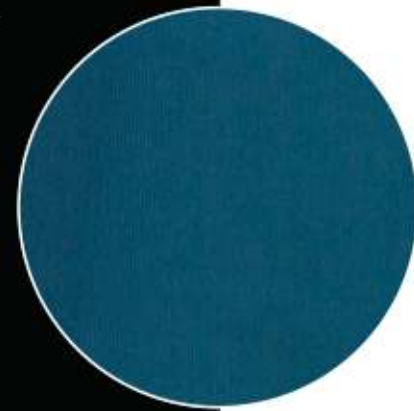

EXTRAFIBER



c/145 Verde petrolio

c/144 Melanzana

c/001 Nero

c/101 Bianco

c/139 Grigio antracite

RIF. 616900 Óscar
Uomo
EXTRAFIBER 210 g/m²
93% PES 7% EA
XS-YL

RIF. 661400 Olaya
Donna
EXTRAFIBER 210 g/m²
93% PES 7% EA
XS-YL

Tutti i colori disponibili da uomo e da donna

gary's
RED LINE

**Il disegno
e la comodità
al prezzo
migliore**





CARATTERISTICHE DEL SERGE

- Massimo comfort e durabilità
- Grande resistenza al peeling da sfregamento
- Tatto morbido

gary's
RED LINE



RIF. 659800 Maite
Donna
SERGE 180 g/m²
65% PES 35% CO
XSS-YL

c/101 Bianco

COOLMAX[®]



RIF. 615900 Adán
Uomo
SERGE 180 g/m²
65% PES 35% CO
XS-2YL

c/101 Bianco

COOLMAX[®]



RIF. 615800 Denis
Uomo
SERGE 180 g/m²
65% PES 35% CO
XS-2YL

c/101 Bianco

COOLMAX[®]



RIF. 659700 Ariel
Donna
SERGE 180 g/m²
65% PES 35% CO
XSS-YL

c/101 Bianco

COOLMAX[®]





RIF. 659900 Edume
Donna
SERGE 180 g/m²
65% PES 35% CO
XSS-YL

c/101 Bianco

COOLMAX[®]





RIF. 616100 Artur
Uomo
SERGE 180 g/m²
65% PES 35% CO
XS-2YL

c/101 Bianco

COOLMAX



gary's
RED LINE

RIF. 616200 Joel
Uomo
SERGE 180 g/m²
65% PES 35% CO
XS-2YL

c/101 Bianco

COOLMAX



RIF. 660600 Silvia
Donna
SERGE 180 g/m²
65% PES 35% CO
XSS-YL

c/101 Bianco

COOLMAX



Pantaloni RED LINE

Serge

COOLMAX[®]

RIF. 704300
Unisex
SERGE 180 g/m²
65% PES 35% CO
Taglie: XSS-2YL



c/101 Bianco



gary's
RED LINE

RIF. 657500 Gema
Donna
JASPER 126 g/m²
100% PES
XS-YL

CARATTERISTICHE DEL JASPER

- Massimo comfort e durabilità
- Grande resistenza al peeling da sfregamento
- Tatto morbido
- Tecnologia che blocca il passaggio di schizzi d'acqua e fluidi.



c/907 Sabbia vigore

c/904 Acqua marina vigore

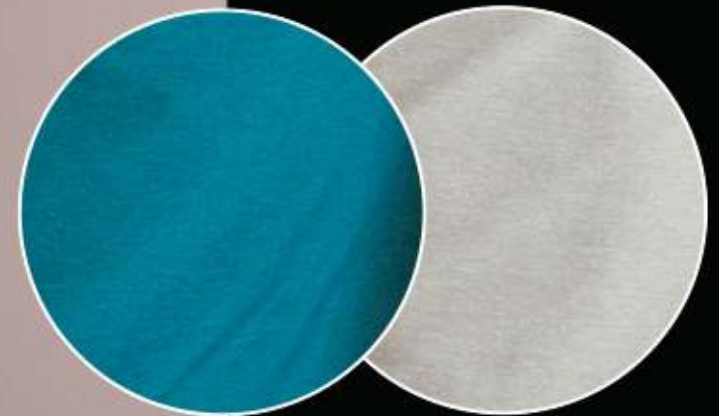

RIF. 657400 Cintia
Donna
JASPER 126 g/m²
100% PES
XS-YL



c./907 Sabbia vigore

c./904 Acqua marina vigore

RIF. 614100 Eric
Uomo
JASPER 126 g/m²
100% PES
XS-YL



c./904 Acqua marina vigore

c./907 Sabbia vigore

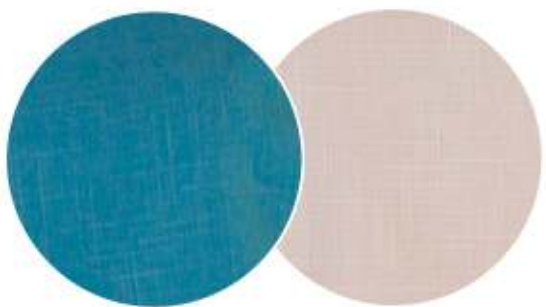

X.LINEN

LOOK DEL LINO
FORMA ELASTICA
TRASPIRANTE
MORBIDO AL TATTO

x.Linen



x.Linen
by Gary's Workwear

RIF. 617600 Germán
Uomo
X.LINEN 195 g/m²
65% PES 30% VI 5% EA
XS-YL



RIF. 662300 Mirta
Donna
X.LINEN 195 g/m²
65% PES 30% VI 5% EA
XS-YL



RIF. 612300 Álex
Uomo
OXFORD 130 g/m²
70% CO 30% PES
XS-YL

c/117 Grigio perla

RIF. 656200 Brenda
Donna
OXFORD 130 g/m²
70% CO 30% PES
XS-YL

c/117 Grigio perla



RIF. 656400 Camila
Donna
OXFORD 130 g/m²
70% CO 30% PES
XS-YL

c/117 Grigio perla

RIF. 613100 André
Uomo
OXFORD 130 g/m²
70% CO 30% PES
XS-YL

c/117 Grigio perla



CARATTERISTICHE DELL'OXFORD

- Tessuto leggero
- Alta traspirabilità
- Elevata morbidezza
- Treccia geometrica che dona texture
- Alterna i due colori di filo



**Tutti i colori di-
sponibili da uomo
e da donna**

PEACH

- Tecnologia che blocca il passaggio di schizzi d'acqua e fluidi.
- Alta traspirabilità
- Texture buccia di pesca
- Finiture satinata
- Linee ineguagliabili



c/153 Blu petrolio



Tessuto tecnico
traspirante



RIF. 615700 Izan
Uomo
PEACH 125 g/m²
100% PES
XS-YL

c/149 Verde cachi



c/157 Nude



RIF. 658900 Lia
Donna
PEACH 125 g/m²
100% PES
XS-YL





RIF. 615400 Dario
Uomo
JEANS 195 g/m²
78% PES 18% VI 4% EA
XS-YL



 aerosilver

c/835 Jeans Persia

RIF. 658500 Joana
Donna
JEANS 195 g/m²
78% PES 18% VI 4% EA
XS-YL

c/835 Jeans Persia

JEANS

garysworkwear.com





CARATTERISTICHE DEL SERGE

- Massimo comfort e durabilità
- Grande resistenza al peeling da sfregamento
- Tatto morbido

gary's WORKWEAR

RIF. 607400 Dama
CAPI SENZA PASSANTI

Donna
SERGE 200 g/m²
65% PES 35% CO
XS-YL

c/101 Bianco



RIF. 610100 Abel
CAPI SENZA PASSANTI

Uomo
SERGE 200 g/m²
65% PES 35% CO
XS-YL

c/101 Bianco



RIF. 608200 Passanti
PACK 2 Accessorio tasche
Taglia unica

c/127 Pistacchio
c/107 Azzurro
c/119 Malva
c/116 Arancione
c/115 Turchese
c/117 Grigio perla



RIF. 661900 Claudia
Donna
SERGE 200 g/m²
65% PES 35% CO
XS-YL

c/101 Bianco



RIF. 617300 Camilo
Uomo
SERGE 200 g/m²
65% PES 35% CO
XS-YL

c/101 Bianco



**I capi sono venduti
con le parti in bianco**



**VARI COLORI
DA ABBINARE AL CAPO**

RIF. 618200 PACK 2 TRIANGOLI + 1 CINTURA donna
RIF. 618100 PACK 2 TRIANGOLI + 1 CINTURA uomo

Taglie P (xss/xs/s)
M (M/L/XL)
G (XXL/YL)

c/001 Nero
c/127 Pistacchio
c/138 Lampone
c/115 Turchese
c/117 Grigio perla
c/104 Navy



RIF. 661700 Nagore
Donna
SERGE 200 g/m²
65% PES 35% CO
XS-YL

c/101 Bianco





RIF. 534000 Oporto
Donna
SERGE 200 g/m²
65% PES 35% CO
XS-YL

c/101 Bianco



RIF. 661500 Amanda
Donna
SERGE 200 g/m²
65% PES 35% CO
XS-YL

c/101 Bianco

RIF. 610200 Leo
Uomo
SERGE 200 g/m²
65% PES 35% CO
XS-YL

c/101 Bianco

RIF. 607300 Celia
Donna
SERGE 200 g/m²
65% PES 35% CO
XS-YL

c/101 Bianco



RIF. 607200 Vega
Donna
SERGE 200 g/m²
65% PES 35% CO
XS-YL

c/101 Bianco

Blusa aderente



RIF. 662800 Leila
Donna
SERGE 200 g/m²
65% PES 35% CO
XS-YL

c/101 Bianco



Bottoni automatici nascosti

RIF. 617900 Edgar
Uomo
SERGE 200 g/m²
65% PES 35% CO
XS-YL

c/101 Bianco



RIF. 650000
Unisex
SERGE 200 g/m²
65% PES 35% CO
XSS-YL

c/101 Bianco

Unisex.

RIF. 530000 manica lunga
Donna
SERGE 200 g/m²
65% PES 35% CO
XS-YL

c/101 Bianco

RIF. 531000 manica corta
Donna
SERGE 200 g/m²
65% PES 35% CO
XS-YL

c/101 Bianco

RIF. 571000 manica corta
Unisex
SERGE 200 g/m²
65% PES 35% CO
XSS-YL

c/101 Bianco

Camici



gary's WORKWEAR

RIF. 610300 Omar
Uomo
SERGE 200 g/m²
65% PES 35% CO
XS-YL

c/101 Bianco

RIF. 607700 Julia
Donna
SERGE 200 g/m²
65% PES 35% CO
XS-YL

c/101 Bianco

RIF. 570000
Manica lunga
Uomo
SERGE 200 g/m²
65% PES 35% CO
XSS-YL

c/101 Bianco

RIF. 540000
Manica lunga con polsino e
bottone
Donna
SERGE 200 g/m²
65% PES 35% CO
XSS-YL

c/101 Bianco

RIF. 541000
Manica corta
Donna
SERGE 200 g/m²
65% PES 35% CO
XSS-YL

c/101 Bianco



RIF. 543000
Manica lunga senza
polsino
Donna
SERGE 200 g/m²
65% PES 35% CO
XSS-YL

c/101 Bianco



Bambino.



RIF. 357100 Roxana
Bambino
SERGE 200 g/m²
65% PES 35% CO
Taglie 4, 8 e 12

c/101 Bianco

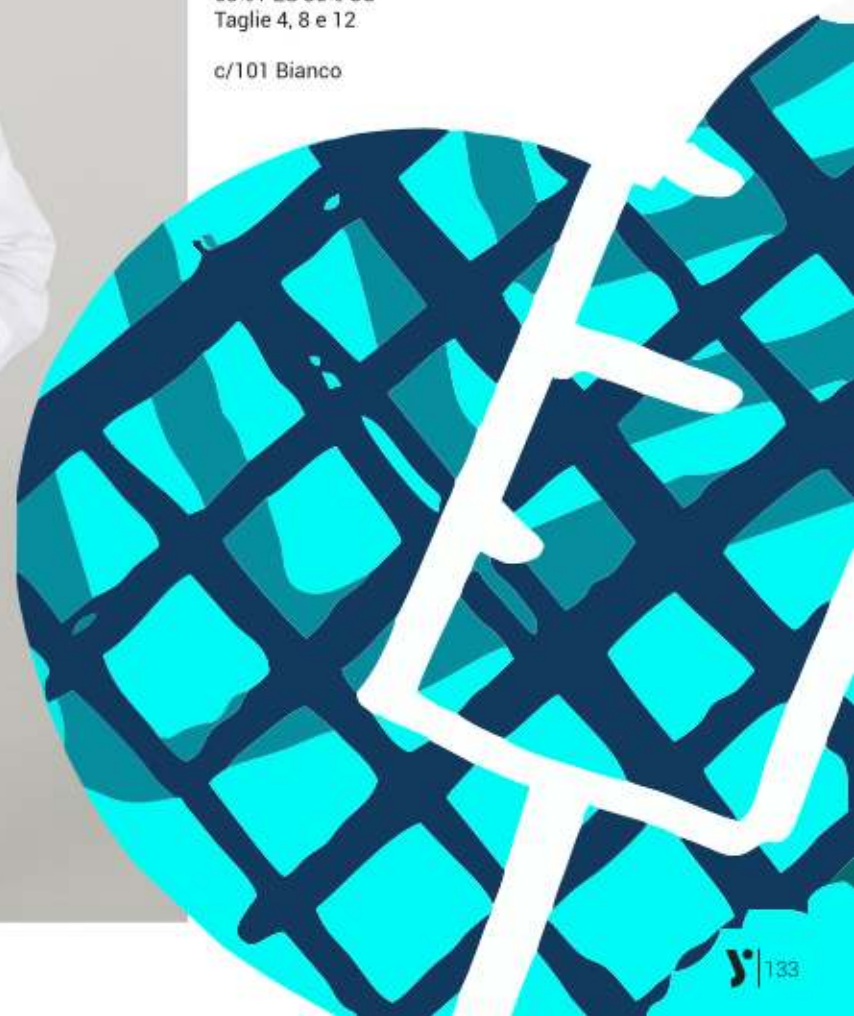

RIF. 542000 Laura manica
3/4
Donna
SERGE 200 g/m²
65% PES 35% CO
XS-YL

c/101 Bianco

RIF. 542100 Laura manica lunga
Donna
SERGE 200 g/m²
65% PES 35% CO
XS-YL

c/101 Bianco



gary's WORKWEAR

Total color

SERGE

RIF. 605000
Blusa colorata manica corta
Unisex
SERGE 200 g/m²
65% PES 35% CO
XS-YL



c/122 Vaniglia



c/119 Malva



c/141 Sabbia



c/124 Marrone



c/125 Fucsia



c/123 Lilla



c/001 Nero



c/136 Viola



c/127 Pistacchio



c/116 Arancione



c/139 Grigio antracite



c/121 Verde oliva



c/115 Turchese



c/138 Lampone

c/117 Grigio perla



c/112 Bordeaux

c/107 Azzurro

c/103 Blu

c/108 Verde

RIF. 840000 Completo bianco
Pantaloni bottone
Unisex
SERGE 200 g/m²
65% PES 35% CO
XSS-YL
c/101 Bianco

RIF. 841100 Completo bianco
Pantaloni gomma
Unisex
SERGE 200 g/m²
65% PES 35% CO
XSS-YL
c/101 Bianco

RIF. 843000 Completo colorato
Pantaloni bottone
Unisex
SERGE 200 g/m²
65% PES 35% CO
XS-YL

RIF. 603000 Blusa manica corta
colorata
Unisex
SERGE 200 g/m²
65% PES 35% CO
XS-YL



RIF. 601000 Blusa manica corta bianca
Unisex
SERGE 200 g/m²
65% PES 35% CO
XSS-YL

Plus sizes
2YL-3YL-4YL-5YL

c/101 Bianco

RIF. 772G00 Pantaloni
Unisex
SERGE 200 g/m²
65% PES 35% CO
XSS-YL

Plus sizes
2YL-3YL-4YL-5YL

c/101 Bianco





c/107 Azzurro



c/108 Verde



c/101 Bianco

RIF. 844000 Completo colorato bottone
Unisex
SERGE 200 g/m²
65% PES 35% CO
XS-YL

c/108 Verde
c/107 Azzurro

RIF. 842000 Completo bianco bottone
Unisex
SERGE 200 g/m²
65% PES 35% CO
XS-YL

c/101 Bianco

RIF. 604000 Blusa manica corta colorata
Unisex
SERGE 200 g/m²
65% PES 35% CO
XS-YL

c/108 Verde
c/107 Azzurro

RIF. 602000 Blusa manica corta bianca
Unisex
SERGE 200 g/m²
65% PES 35% CO
XSS-YL

c/101 Bianco



RIF. 623500 Sicilia
Manica corta
Donna
SERGE 200 g/m²
65% PES 35% CO
XS-YL

c/101 Bianco



c/123 Lilla



Tutti i colori disponibili a manica corta e a manica lunga

Women's Classics

Rif. 623600 Sicilia
Manica lunga
Donna
SERGE 200 g/m²
65% PES 35% CO
XS-YL



c/119 Malva



c/115 Turchese



c/107 Azzurro



CARATTERISTICHE DEL PIQUÉ

- Facile da lavare e da asciugare
- Tessuto fresco, morbido e comodo
- Texture porosa



RIF. 614000 Pré-maman
Donna
PIQUÉ 167 g/m²
65% PES 35% CO
XS-XXL

c/001 Nero - c/101 Bianco

gary's WORKWEAR





RIF. 657200 Chantal
Unisex
SERGE 200 g/m²
65% PES 35% CO
XS-YL

c/101 Bianco - c/ Nero

RIF. 556000 Donna incrociato
Donna
SERGE 200 g/m²
65% PES 35% CO
P-M-G-SG

c/101 Bianco

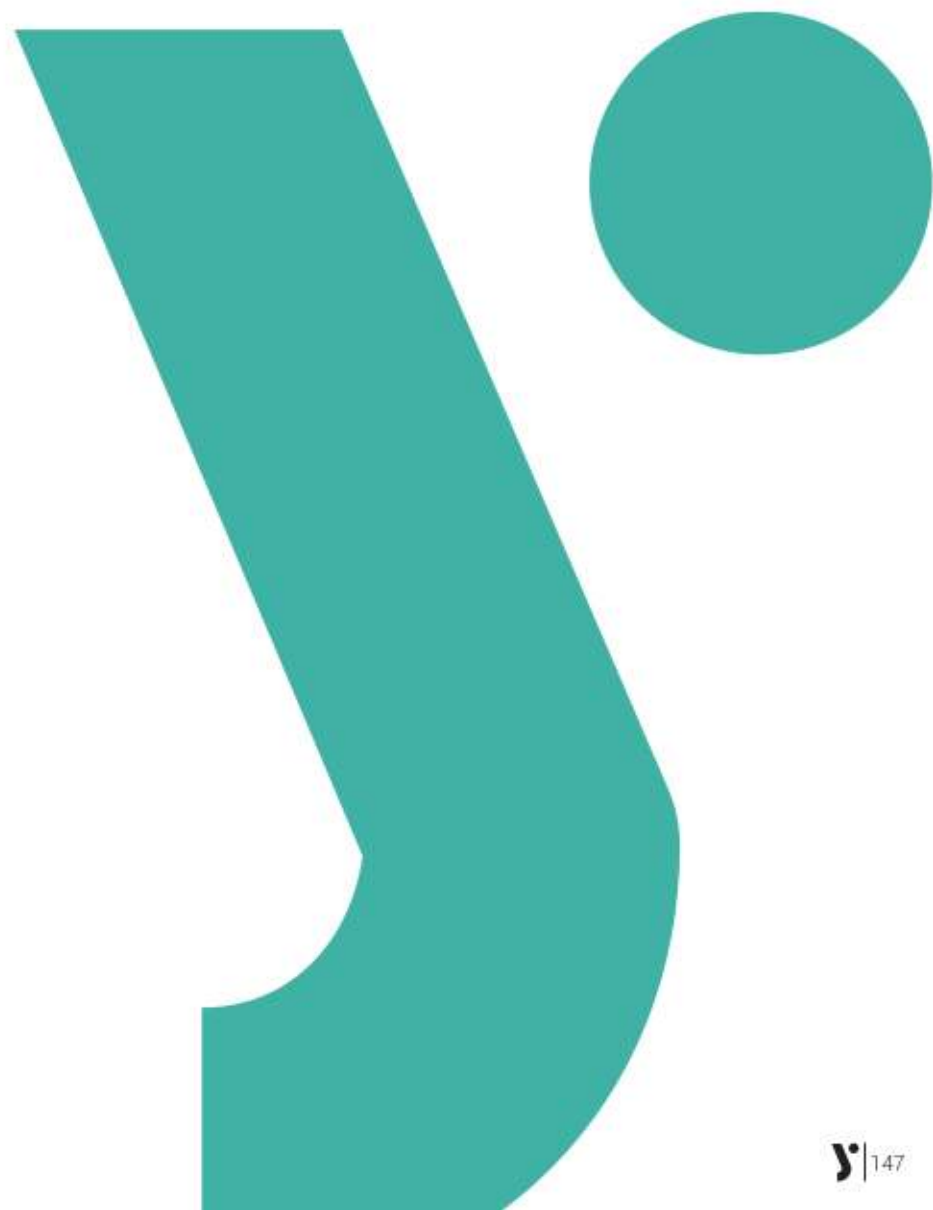



**Sviluppo e produzione
di ogni tipo di capo in maglia.
Scegli tu il modello, la combinazione
e il colore.**

CARATTERISTICHE DELLA MAGLIA

- Durabilità
- Conservazione
- Resistenza
- Comodità
- Meno cure

La maglia.

RIF. 102500 Cardigan
Donna
MAGLIA
Trama 10 a 2 fili 2/42
70% Dralon acrilico
30% Lana merino
Taglie 38-52

RIF. 102600 Cardigan
Uomo
MAGLIA
Trama 10 a 2 fili 2/42
70% Dralon acrilico
30% Lana merino
Taglie 46-60



c/001 Nero

c/139 Grigio-antracite



c/104 Navy



c/104 Navy

c/001 Nero



c/001 Nero

c/104 Navy

RIF. 103200
Uomo
Trama 10 a 2 fili 2/42
70% Dralon acrilico
30% Lana merino
Taglie 46-60

Giacche in maglia fine

RIF. 103100
Donna
Trama 10 a 2 fili 2/42
70% Dralon acrilico
30% Lana merino
Taglie 38-52

RIF. 102800
Uomo
Trama 8 a 2 fili 2/22
100% Acrilico
Taglie 46-60

RIF. 102900
Donna
Trama 8 a 2 fili 2/22
100% Acrilico
Taglie 38-52

c/104 Navy

c/001 Nero

c/104 Navy

c/001 Nero

Giacche in
maglia spessa

RIF. 103300
Donna
Trama 12 a 1 filo 2/28
70% Dralon acrilico
30% Poliammide
Taglie 38-52

**Senza
bottoni**

c/104 Navy

c/001 Nero



RIF. 102700
Donna
MAGLIA 100% Dralon acrilico
Trama 10 a 1 filo 2/22
Taglie 38-52

c/101 Bianco



RIF. 100100
Donna
MAGLIA 100% Dralon acrilico
Taglie 40-64

c/104 Navy



RIF. 841500 Completo paziente bambino
POPELINE CAMICIA 108 g/m²
65% PES 35% CO
TAGLIE: 2-4, 6-8, 10-12, 14-16

c/704 Azzurro

PANTALONI CON LACCIO



RIF. 845100 Completo paziente
Unisex
POPELINE CAMICIA 108 g/m²
65% PES 35% CO
Taglie XS-XXL

c/704 Azzurro

PANTALONI CON BOTTONI E LACCIO



RIF. 595100 Camice paziente
Unisex
POPELINE CAMICIA 108 g/m²
65% PES 35% CO
Taglia unica

c/704 Azzurro

CARATTERISTICHE DEL POLIURETANO

- Non danneggia la pelle
- Resistenza alla penetrazione dei liquidi.
- Resistenza alla penetrazione microbica se inumidito.
- 40 cicli di lavaggio a 90 °C.

RIF. 450700 Passamontagna
Unisex
Taglia unica
Strato est. POLIURETANO 80 g/m²
Strato int. INTERLOCK 50 g/m²

c/101 Bianco

RIF. 595200 Camice impermeabile
Unisex
Taglia unica
Strato est. POLIURETANO 80 g/m²
Strato int. INTERLOCK 50 g/m²

c/101 Bianco

RIF. 486300 Gambale
1 PAR
Unisex
Taglia unica
Strato est. POLIURETANO 80 g/m²
Strato int. INTERLOCK 50 g/m²

c/101 Bianco





RIF. 450800 Berretto con elastico
Unisex
MICROFIBRA 148 g/m²
100% PES

c/4062 Arcobaleno

RIF. 450900 Berretto con lacci
regolabili
MICROFIBRA 148 g/m²
100% PES

c/4062 Arcobaleno



Special edition

#andratuttobene
#fermiamoilvirusinsieme





RIF. 611500 Blusa Andrà tutto bene
Unisex
MICROFIBRA 148 g/m²
100% PES
XSS-YL

c/4062 Arcobaleno



RIF. 160100 Grembiule
Unisex
STRETCH 165 g/m²
100% PES
Taglia unica

c/4062 Arcobaleno

Il 100% dei ricavi saranno devoluti alla Croce Rossa spagnola per aiutare le persone rese vulnerabili dalla crisi causata dal Covid-19 mediante programmi di assistenza sociale.

POCOYO™

X GARY'S®

RIF. 611300 Blusa Pocoyo
Unisex
MICROFIBRA 148 g/m²
100% PES
XSS-YL

c/104 Navy



RIF. 611300 Blusa Pocoyo
Unisex
MICROFIBRA 148 g/m²
100% PES
XSS-YL

c/101 Bianco



Tasche
lateral
nascoste



RIF. 445500 Berretto da chirurgo con lacci
MICROFIBRA 148 g/m²
100% PES
Taglia unica

c/2873 Pocoyo

RIF. 600100 Camice corto Pocoyo
Donna
MICROFIBRA 148 g/m²
100% PES
XS-YL

c/2873 Pocoyo

RIF. 583600 Camice corto Pocoyo
Uomo
MICROFIBRA 148 g/m²
100% PES
XS-YL

c/2873 Pocoyo



RIF. 445400 Berretto da chirurgo con elastico
MICROFIBRA 148 g/m²
100% PES
Taglia unica

c/2873 Pocoyo





c/2866 Rosa

RIF. 447400 Berretto con elastico
Unisex
Taglia unica
MICROFIBRA 148 g/m²
100% PES

RIF. 447300 Berretto con lacci
regolabili
Unisex
Taglia unica
MICROFIBRA 148 g/m²
100% PES

gary's WORKWEAR

Il 50% dei ricavi saranno devoluti
all'Associazione spagnola contro il cancro.



c/2867 November



c/2833 Nastro



RIF. 159700 Grebiule Hope
Unisex con tasca
STRETCH 165 g/m²
100% PES
Taglia unica

c/888



RIF. 370100 Borsa Hope
STRETCH 165 g/m²
100% PES
Taglia unica

c/888

RIF. 614800 Blusa Hope
Donna
MICROFIBRA 148 g/m²
100% PES
XSS-YL

c/888

RIF. 212300 Casacca Hope
Donna
STRETCH 165 g/m²
100% PES
Taglia unica

c/888





Happier Workplaces

garysworkwear.com



**Berretti
sanitari**

Tessuto assorbente per la sudorazione frontale interna. Tutti i colori sono disponibili in entrambi i modelli.



c/127 Pistacchio



c/101 Bianco



c/107 Azzurro

c/112 Bordeaux



c/138 Lampone



c/001 Nero



c/105 Rosso



c/108 Verde



c/139 Grigio antracite



c/119 Malva



c/115 Turchese



c/142 Sabbia



c/104 Navy



RIF. 447700
Berretto con lacci regolabili
Unisex
Taglia unica
MICROFIBRA 148 g/m²
100% PES

RIF. 447600
Berretto con elastico
Unisex
Taglia unica
MICROFIBRA 148 g/m²
100% PES

Possibilità di personalizzare tutti i modelli dei berretti con bottoni laterali per fissare l'elastico della mascherina.



c/2882 Stelle



c/2876 Fonendoscopio



c/2887 Foglie



c/2889 Incisivo



c/2878 Woof



c/2885 Pet Shop

RIF. 447300
Berretto con lacci regolabili
Unisex
Taglia unica
MICROFIBRA 148 g/m²
100% PES



c/2884 Cuore



c/2875 Guanto



c/2881 Molari



c/2879 Cats



c/2877 Sorriso



c/2886 Fiore arcobaleno

RIF. 447400
Berretto con elastico
Unisex
Taglia unica
MICROFIBRA 148 g/m²
100% PES

RIF. 445800
Berretto con lacci regolabili

RIF. 445900
Berretto con elastico

Unisex
Taglia unica
MICROFIBRA 145 g/m²
100% POLIESTERE RICICLATO



c/2896 Germogli



c/2894 Corteccia



c/2895 Fucus



c/2897 Save



RIF. 445600
Berretto con lacci regolabili

RIF. 445700
Berretto con elastico

Unisex
Taglia unica
MICROFIBRA 148 g/m²
100% PES



c/2898 Kukumedici



c/2899 Kukucuori



c/2891 Kukutori



Tessuto assorbente per la sudorazione frontale interna.
Sono disponibili tutte le stampe per i berretti con elastico e per quelli con lacci regolabili.



garysworkwear.com

That's great!



c/2875 Guanto



c/2878 Woolf



c/2881 Molari



c/2884 Cuore



c/2876 Fonendoscopio



c/2889 Incisivo



c/2877 Sorriso



c/2887 Foglie



c/2886 Fiore arcobaleno



c/2882 Stelle



c/2885 Pet shop



c/2879 Cats



c/2883 Zoo



c/2891 Kukutori



c/2898 Kukumediçi



c/2899 Kukucuori

RIF. 121300
CALZINI
ES 85% SoftAir 8% Poliammide 7% EA

Taglie: EUR UK USA
M - 35 - 41 2.5 - 7 4 - 7.5
L - 42 - 46 8 - 11 9 - 11.5



CONFORT



TRANSPIRABLE



TERMORREGULADOR

gary's Happier
Workplaces

**Pantaloni
per il
SETTORE
SANITARIO**



100% Microfibra

RIF. 700600

Unisex

XSS-YL

100% PES 148 g/m²

Regular fit

Plus sizes

2YL-3YL-4YL-5YL

(Rif. 700600 c/101 Bianco
e c/001 Nero)



c/101 Bianco



c/001 Nero



c/139 Grigio antracite



c/115 Turchese



c/107 Azzurro



c/104 Navy



c/108 Verde



c/127 Pistacchio



c/119 Malva



c/105 Rosso



c/112 Bordeaux



c/138 Lampone



c/001 Nero



c/101 Bianco

Pré-maman

RIF. 772500
Donna
XS-XXL
Piqué 167 g/m²
65% PES 35% CO
Straight leg



c/101 Bianco



c/001 Nero



c/142 Sabbia

1% Microfibra

RIF. 702400
Pantaloni tasca laterale
Donna
XS-YL
100% PES 148 g/m²
Regular fit



c/139 Grigio antracite



c/127 Pistacchio



c/104 Navy



c/115 Turchese



c/119 Malva

Pantaloni jogger

RIF. 704700

Unisex

MICROFIBRA 360 - 170 g/m²

95% PES 5% EA

Taglie: XSS-YL



c/108 Verde



c/103 Blu



c/136 Viola



c/152 Blu grigiastro



c/128 Senape



c/106 Rosa



c/145 Verde petrolio



c/133 Corallo



c/155 Verde acqua



c/001 Nero



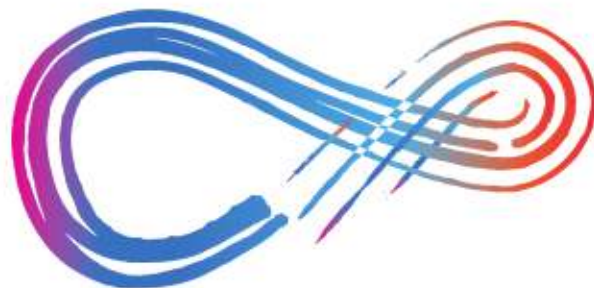

MICROFIBRA 360

con trattamento

SILVADUR™
The Science of Intelligent Freshness



c/123 Lilla



c/152 Blu grigiastro



c/133 Corallo



c/101 Bianco

Pantaloni con tasca americana

RIF. 704800
Donna
MICROFIBRA 360 - 170 g/m²
95% PES 5% EA
Taglie: XS-YL



c/128 Senape



c/136 Viola



c/106 Rosa



Microfibra 100% Poliestere

RIF. 703700
Donna
MICROFIBRA 148 g/m²
100% PES
Taglie: XS-YL



c/119 Malva



c/139 Grigio antracite



Microfibra Elastik

RIF. 702800
Unisex
MICROFIBRA ELASTIK 155 g/m²
99% PES 1% EA
Taglie: XS-YL



c/101 Bianco



c/001 Nero



Jasper

RIF. 702600
Unisex
JASPER 126 g/m²
100% PES
Taglie: XS-YL



Microfibra 100% Poliestere

RIF. 704400
Donna
MICROFIBRA 148 g/m²
100% PES
Taglie: XS-YL



c/001 Nero



c/101 Bianco



c/904 Acqua marina vigoré



c/907 Sabbia vigoré

X.Linen

RIF. 704900
Unisex
X.LINEN 195 g/m²
65% PES 30% VI 5% EA
Taglie: XSS-YL



c/155 Verde acqua



c/110 Beige



c/153 Blu petrolio



c/157 Nude



c/149 Verde cachi

Peach

RIF. 704200
Unisex
PEACH 125 g/m²
100% PES
Taglie: XSS-YL



RIF. 203800 Pantaloni JEANS
Donna
SATIN 200 g/m²
97% CO 3% EA
Taglie: 36-52
c/001 Nero - c/101 Bianco



Satin Elastik



RIF. 204000 Pantaloni
Donna
SATIN 200 g/m²
97% CO 3% EA
Taglie: 36-52
c/001 Nero - c/101 Bianco



c/104 Navy



c/101 Bianco

Peach

RIF. 702700
Unisex
PEACH 125 g/m²
100% PES
Taglie: XS-YL



Jeans

RIF. 703800
Unisex
JEANS 230 g/m²
78% PES 18% VI 4% EA
Taglie: XSS-YL



c/835 Jeans Persia

Oxford

RIF. 702500
Pantaloni con sbieco e tasche
Unisex
OXFORD 130 g/m²
70% CO 30% PES
Taglie: XS-YL



c/117 Grigio perla



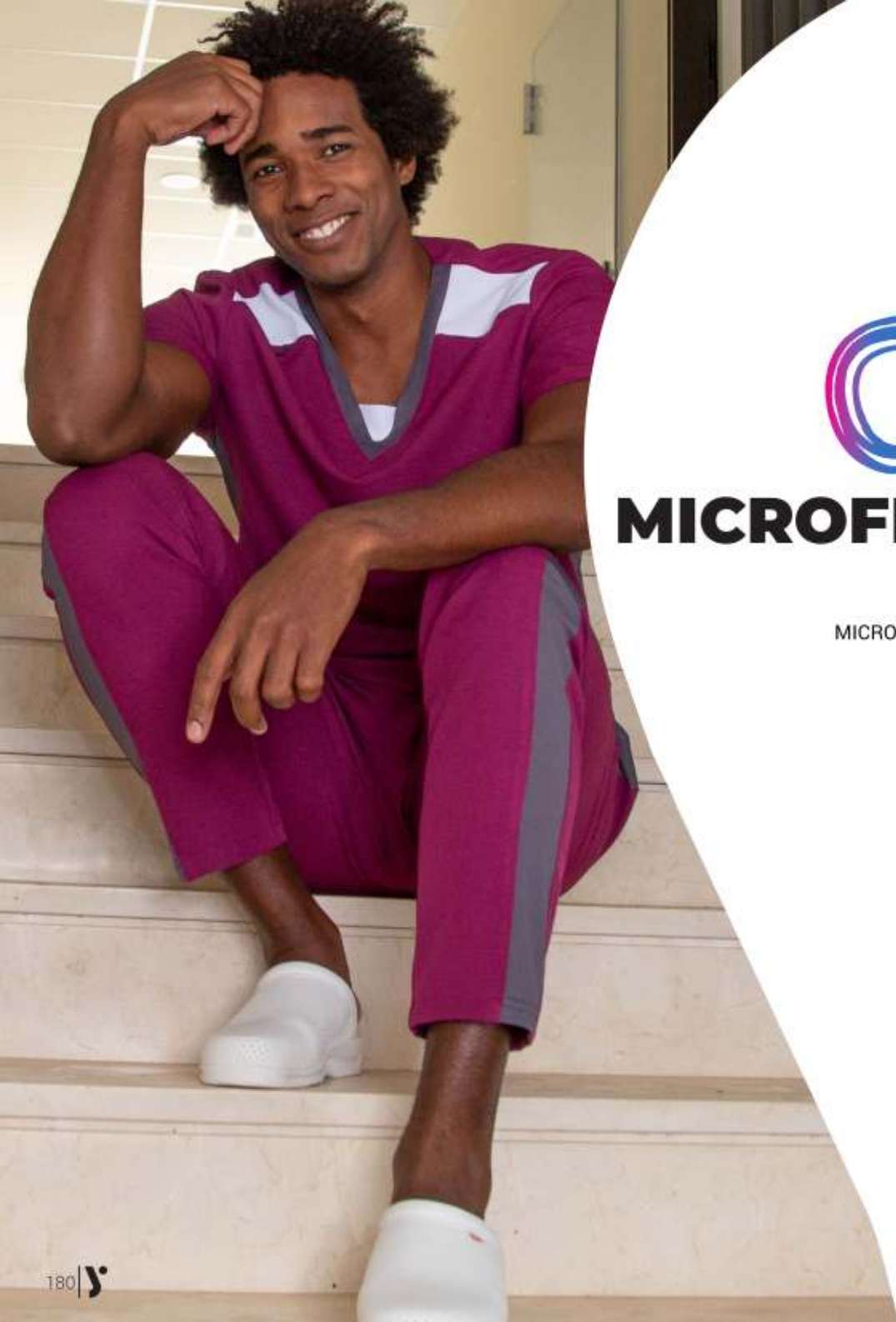

MICROFIBRA 360

RIF. 704600

Unisex

MICROFIBRA 360 VIGORÉ 170 g/m²

95% PES 5% EA

Taglie: XSS-YL



c/149 Verde cachi



c/139 Grigio antracite



c/117 Grigio perla



c/119 Malva



Extrafiber

RIF. 704500
Unisex
EXTRAFIBER 210 g/m²
93% PES 7% EA
Taglie: XSS-YL



c/001 Nero



c/139 Grigio antracite



c/101 Bianco



c/144 Melanzana



c/145 Verde petrolio



c/101 Bianco



c/144 Melanzana



c/145 Verde petrolio



c/001 Nero



c/139 Grigio antracite

Extrafiber

RIF. 702900
Unisex
EXTRAFIBER 210 g/m²
93% PES 7% EA
Taglie: XSS-YL

garysworkwear.com



c/104 Navy



c/103 Blu



c/107 Azzurro



c/108 Verde



c/106 Rosa



c/105 Rosso



c/112 Bordeaux



c/001 Nero

Serge

65% Poliestere

35% Cotone

RIF. 773G00

Pantaloni con elastico e tasche

Unisex

Serge 200 g/m²

Taglie: XS-YL

Regular fit

Plus sizes

2YL-3YL-4YL-5YL

c/001 Nero



RIF. 772G00

Pantaloni bianchi
con elastico e tasche
Unisex

Serge 200 g/m²

Taglie: XSS-YL

Regular fit

Plus sizes

2YL-3YL-4YL-5YL

RIF. 7733G0
Pantaloni con elastico e tasche
Unisex
Serge 200 g/m²
65% PES - 35% CO
Taglie: XS-YL
Regular fit



c/141 Crema



c/116 Arancione



c/122 Vaniglia



c/138 Lampone



c/123 Lilla



c/136 Viola



c/121 Verde oliva



c/139 Grigio antracite



c/127 Pistacchio



c/119 Malva



c/115 Turchese



c/125 Fucsia



c/117 Grigio perla

Serge

65% Poliestere

35% Cotone

RIF. 773000

Pantaloni con chiusura lampo e tasche

Unisex

Serge 200 g/m²

Taglie: XS-YL

Regular fit



c/001 Nero



c/107 Azzurro



c/103 Blu



c/104 Navy



c/105 Rosso



c/127 Pistacchio



c/115 Turchese



c/123 Lilla



c/119 Malva



c/125 Fucsia

RIF. 773300

Pantaloni con chiusura lampo e tasche

tasche

Unisex

Serge 200 g/m²

Taglie: XS-YL

Regular fit



c/112 Bordeaux



c/108 Verde

Serge

RIF. 700500
Pantaloni con elastico e cordino
Unisex
Serge 200 g/m²
65% PES - 35% CO
Taglie: XS-YL
Regular fit

c/101 Bianco



Serge elasticizzato

RIF. 703100
Pantaloni multi-tasca
Unisex
SERGE ELASTICO 206 g/m²
59% CO 39% PES 2% EA
Taglie: XS-YL



c/001 Nero



c/101 Bianco



c/124 Marrone



RIF. 772000
Pantaloni bianchi
chiusura lampo e tasche
Unisex
Serge 200 g/m²
Taglie: XSS-YL
Regular fit

c/101 Bianco



garysworkwear.com



Settore delle pulizie

RIF. 561200 Granada
Donna
VICHY 118 g/m²
65% PES 35% CO
XS-YL



c/412 Righe bordeaux



c/402 Righe navy



c/403 Righe azzurre

c/204 Quadretti azzurri



c/205 Quadretti verdi



c/203 Quadretti blu



RIF. 521000 Camice manica corta
Donna
VICHY 118 g/m²
65% PES 35% CO
XS-YL

c/303 Righe azzurre



c/304 Righe verdi



c/302 Righe blu



c/205 Quadretti verdi



c/203 Quadretti blu

RIF. 520000 Camice manica lunga
Donna
VICHY 118 g/m²
65% PES 35% CO
XS-YL



c/204 Quadretti azzurri



c/304 Righe verdi



c/302 Righe blu



c/303 Righe azzurre

RIF. 609300 Noelia
Donna
VICHY 118 g/m²
65% PES 35% CO
XS-YL



c/123 Lilla



c/127 Pistacchio

RIF. 522000
Donna
VICHY 118 g/m²
65% PES 35% CO
XS-YL

c/404 Righe verdi

c/403 Righe azzurre



c/412 Righe bordeaux

c/402 Righe navy

RIF. 647000
Unisex
VICHY 118 g/m²
65% PES 35% CO
XS-YL



c/403 Righe azzurre

c/404 Righe verdi

c/406 Righe rosa

RIF. 652000
Unisex
VICHY 118 g/m²
65% PES 35% CO
XS-YL



c/403 Righe azzurre



c/406 Righe rosa



c/404 Righe verdi

RIF. 648000
Unisex
VICHY 118 g/m²
65% PES 35% CO
XS-YL



c/404 Righe verdi

c/403 Righe
azzurre



Happier Workplaces

garysworkwear.com



**Microfibra
100% Poliestere**

RIF. 609900 Emma
Donna
Microfibra 148 g/m²
100% PES
XS-YL

c/001 Nero



RIF. 662700 Fátima
Donna
Microfibra 148 g/m²
100% PES
XS-YL

c/101 Bianco



c/001 Nero





RIF. 558000
Donna
Serge 200 g/m²
65% PES 35% CO
XSS-YL

c/101 Bianco



Serge
65% Poliestere
35% Cotone

RIF. 662600 Noemi
Donna
Serge 200 g/m²
65% PES 35% CO
XS-YL

c/108 Verde

c/104 Navy

c/107 Azzurro

RIF. 213100 Estela
Donna
SERGE 200 g/m²
65% PES 35% CO
Taglia unica

c/121 Verde oliva



c/119 Malva



c/104 Navy

RIF. 532000
Donna
SERGE 200 g/m²
65% PES 35% CO
XS-YL

garysworkwear.com



c/108 Verde



c/107 Azzurro



c/104 Navy



c/112 Bordeaux

RIF. 212900 Jimena
Donna
SERGE 200 g/m²
65% PES 35% CO
P-M-G



c/123 Lilla



c/143 Acqua marina



c/122 Vaniglia

gary's WORKWEAR



garysworkwear.com

Settore alimentare

RIF. 608300 Adela
Unisex
SERGE 200 g/m²
65% PES 35% CO
XS-YL

Tasca cucita dall'interno
Polsino in tessuto acrilico



RIF. 700800 Pantaloni settore alimentare
Unisex
SERGE 200 g/m²
65% PES 35% CO
XS-YL

c/101 Bianco - c/104 Navy

Elastico con cordino
e tasca nascosta



c/101 Bianco

c/104 Navy

RIF. 570200 Enzo
VELCRO
Unisex
SERGE 200 g/m²
65% PES 35% CO
XS-YL

c/101 Bianco



Tasca cucita dall'interno
Polsino in tessuto acrilico

**Chiusura con bottoni
automatici nascosti**

RIF. 570100 Reyes
Unisex
SERGE 200 g/m²
65% PES 35% CO
XS-YL

c/101 Bianco



Chiusura con velcro



RIF. 202100 Lucia
Casacca unisex
SERGE 200 g/m²
65% PES 35% CO
Taglia unica

c/101 Bianco



**Lacci elastici regolabili
con bottoni automatici**

Tasca nascosta



RIF. 486000 Manicotto polipropilene
PACK DA 2
Taglia unica. Lunghezza 45 cm.
100% Polipropilene
290 g/m²

RIF. 486200 Manicotto serge
PACK DA 2
Taglia unica. Lunghezza 45 cm.
65% PES 35% CO
200 g/m²

RIF. 125000 Grembiule cerato
Unisex.
Taglia unica. 90 x 70 cm.
100% Polipropilene
290 g/m²



RIF. 115000
Grembiule riccio

RIF. 115AT0
Grembiule riccio alta temperatura
Lavabile a 90 °C
Taglia unica.
90x75 cm.
Riccio/PVC



gary's WORKWEAR

RIF. 124000 SKAY
Unisex senza tasca
Taglia unica. 90x70 cm.
80% PVC - 20% CO
550 g/m²



Caratteristiche del vinile:

- Protezione di base contro l'acqua
- Ideale per hotel, ristoranti e servizi pubblici



RIF. 123000
Grembiule rigido
Unisex. Taglia unica.
110x85 cm.
Cordino regolabile
PVC 100%



RIF. 126200 Grebiule elastomero
Unisex senza tasca
Taglia unica.
115x85 cm.
450 g/m²



CARATTERISTICHE DELL'ELASTOMERO

- Resistenza ai grassi animali, al sangue e ai normali prodotti di pulizia
- Alta flessibilità
- Gradevole da indossare
- Facile da pulire

CARATTERISTICHE DEL VINILE

- Protezione di base contro l'acqua
- Ideale per hotel, ristoranti e servizi pubblici

RIF. 126300 Grembiule vinile
Unisex con tasca
Taglia unica.
115x90 cm.
475 g/m²



RIF. 126100 Grembiule nitrile
Unisex.
Taglia unica.
115x90 cm. Bretelle regolabili.
Nitrile
600 g/m²



CARATTERISTICHE DEL NITRILE

- Elevata resistenza ai grassi animali, al sangue e alle alte temperature
- Maggiore durabilità
- Maggiore flessibilità



RIF. 126500 Peter
Unisex.
Taglia unica.
90x135 cm.
100% Poliuretano
230 g/m²

Caratteristiche del poliuretano:

- Alta resistenza ai grassi animali e al sangue
- Protegge contro i rischi meccanici
- Elevata resistenza alla penetrazione dell'acqua

Colori disponibili:



RIF. 126400 Andrew
Unisex.
Taglia unica.
115x90 cm.
100% Poliuretano
355 g/m²

Bretelle regolabili e occhielli termosigillati, non metallici.



Colori disponibili:





c/115 Turchese



c/116 Arancione



c/123 Lilla



c/119 Malva



c/127 Pistacchio



c/108 Verde



c/001 Nero



c/105 Rosso



c/111 Giallo



c/106 Rosa



c/112 Bordeaux



c/107 Azzurro



c/103 Blu



c/104 Navy



c/202 Quadretti navy



c/124 Marrone



c/125 Fucsia

Berretti

RIF. 415000 RETE PACK 10

Unisex

Taglia unica

65% PES 35% CO

PACK DA 10 UNITÀ



c/108 Verde



c/115 Turchese



c/105 Rosso



c/127 Pistacchio



c/104 Navy



c/001 Nero



c/103 Blu

RIF. 416000 RETE COLOR PACK 10
Unisex
Taglia unica
65% PES 35% CO

PACK DA 10 UNITÀ

RIF. 420000 PACK 10
Unisex
Taglia unica
65% PES 35% CO
Popeline 116 g/m²



c/101 Bianco

RIF. 421000 PACK 10
Unisex
Taglia unica
65% PES 35% CO
Popeline 116 g/m²



c/001 Nero

RIF. 410000 PACK 10

RIF. 410100 RETE MAXI PACK 10

Unisex
Taglia unica
65% PES 35% CO



c/101 Rete bianca

RIF. 422000 PACK 10
Unisex
Taglia unica
65% PES 35% CO



c/101 Bianco



c/001 Nero

garysworkwear.com



c/101/105 Rosso



c/101/112 Bordeaux



c/101/104 Navy



c/101/001 Nero

RIF. 440000 BORDATI PACK 6

Unisex
Taglie P-M-G-SG
65% PES 35% CO



c/103 Blu



c/001 Nero



c/108 Verde



c/105 Rosso



c/112 Bordeaux

RIF. 435000 PACK 6

Unisex
Taglie P-M-G-SG
65% PES 35% CO



c/001 Nero



c/112 Bordeaux

RIF. 449100 PACK 6 BORDATI

Unisex
Taglie P-M-G-SG
65% PES 35% CO



c/104 Navy



c/101 Bianco

RIF. 405100 PACK 10 COPRINUCA

Unisex
Taglia unica
65% PES 35% CO





c/101 Bianco

RIF. 400000 PACK 6
Unisex
Taglie P-M-G-SG
65% PES 35% CO



c/101 Bianco

RIF. 401000 PACK 6
Elastico posteriore
Unisex
Taglia unica
65% PES 35% CO



c/101 Bianco

RIF. 405000 PACK 10
Unisex
Taglia unica
Elastico posteriore
65% PES 35% CO



c/101 Bianco



c/001 Nero

RIF. 446200 PACK 10 BERRETTI RETE
Unisex
Taglia unica
100% PES

RIF. 446100
PACK 6 A COSTE
Unisex
Taglia unica
100% PES
c/101 Bianco - c/001 Nero



RIF. 449600
PACK 6
PASSAMONTAGNA SERGE
BIANCO
Unisex
Taglia unica
65% PES 35% CO
c/101 Bianco



RIF. 449500
PACK 6
PASSAMONTAGNA RETE
Unisex
Taglia unica
100% PES
c/101 Bianco



RIF. 408000
PACK 6
SAHARA RETE
Unisex
Taglia unica
100% PES
c/101 Bianco

RIF. 585000 Sahariana
Unisex
SERGE 200 g/m²
65% PES 35% CO
XS-YL

c/109 Grigio

c/103 Blu

Lavoro



c/104 Navy



c/101 Bianco



c/127 Pistacchio

c/125 Fucsia



c/108 Verde



c/104 Navy



c/112 Bordeaux

RIF. 550000
Donna
SERGE 200 g/m²
65% PES 35% CO
XS-YL

Camice da donna con polsino e bottone



c/001 Nero



c/107 Azzurro



c/136 Viola



c/115 Turchese



c/121 Verde oliva

c/103 Blu



c/112 Bordeaux



c/107 Azzurro



c/108 Verde



Total color

Serge

65% Poliestere
35% Cotone

RIF. 575000

Uomo

SERGE 200 g/m²

65% PES 35% CO

XS-YL



c/001 Nero



c/141 Crema



c/109 Grigio



c/104 Navy



gary's WORKWEAR

CARATTERISTICHE

T400 Technology • Resistente al lavaggio industriale a 90 °C

- Recupera sempre l'elasticità, che è permanente

**ELASTICIDAD
COMODIDAD
RESISTENCIA.**

- Elevato livello di comfort con il mix tra tessuto e design del capo

- Ottimo controllo dell'umidità

- Eccellente resistenza agli elementi chimici

- Trattamento anti-macchia

- Apertura interna per ginocchiere



Controllo dell'umidità



Resistenza chimica



Durabilità



Elasticità



Lavaggio a 90 °C



Comodità



Repellente contro i liquidi

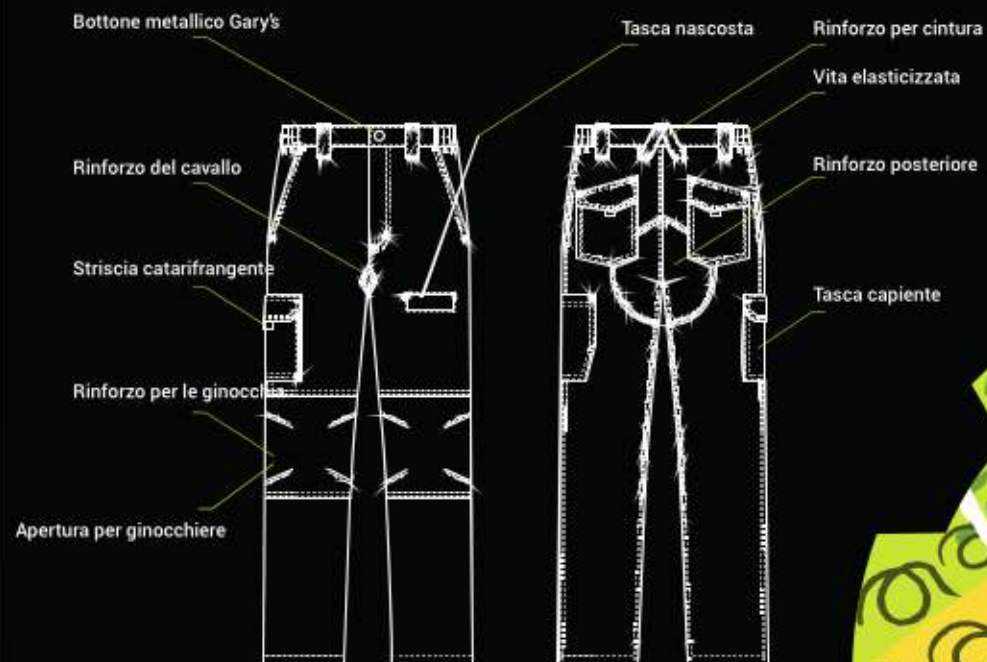



c/109 Grigio



c/104 Navy



c/110 Beige

RIF. 750200 ACERO

Pantaloni unisex multi-tasca
Taglie 34-62

Tessuto elasticizzato T400 245 g/m²
68% PES 28% CO 4% EA



c/001 Nero



c/101 Bianco



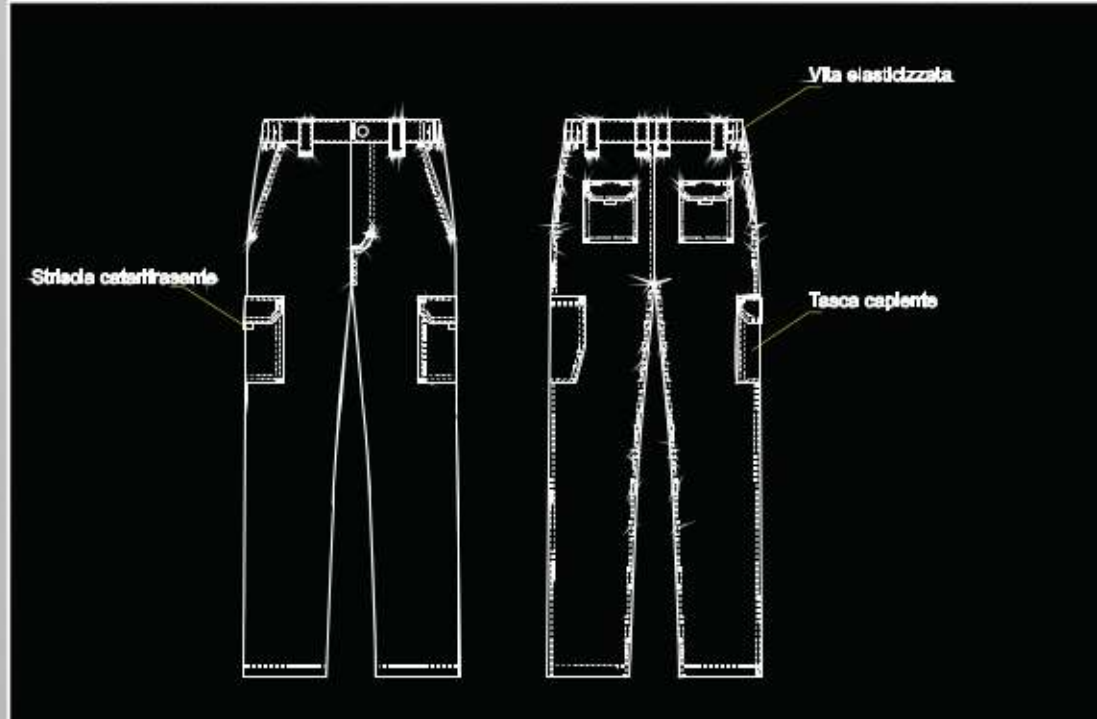



c/104 Navy



c/001 Nero



c/109 Grigio

RIF. 750100 DAINO

Pantaloni unisex multi-tasca
SERGE ELASTICIZZATO 200 g/m²
65% PES 32% CO 2% EA
Taglie 34-62

CARATTERISTICHE

- Elevata elasticità
- Elevato livello di comfort con il mix tra tessuto e design del capo
- Ottimo controllo dell'umidità
- Trattamento anti-macchia



garysworkwear.com



Scopri di più

Consulta i nostri cataloghi Denim, Gastrochef, Horeca, Sartoria, Collezione Camicie, Beauty Hair e Scuola, dove troverai molte collezioni per ogni settore.

garysworkwear.com

gary's
SCUOLA

BEAUTY & HAIR
gary's

gary's
HORECA

gary's *Sastreteria*

GASTROCHEF
by **gary's**

DENIM
gary's

Colección Camisas
Shirt Collection

Happier Workplaces

Hai un'idea?

Possiamo creare qualsiasi disegno. Stampe personalizzate, modelli su misura, personalizzazione di rifiniture, ricami o serigrafie. L'immaginazione non ha limiti e insieme possiamo realizzare la tua idea.

Specializzati nella personalizzazione di indumenti aziendali.

Il nostro team di modellisti e stilisti esperti è specializzato nello sviluppo di proposte mirate, che si adeguano al meglio alle tue necessità e alla tua immagine aziendale. Puntiamo sulla qualità dei tessuti e della confezione. Un abbigliamento personalizzato farà la differenza nella tua attività.

garysworkwear.com



Ricami personalizzati

Stai pensando di personalizzare il tuo capo con un ricamo? Ricamiamo qualsiasi tipo di divisa di lavoro. Grazie ai nostri macchinari di ultima generazione e al nostro team di specialisti, potrai ricamare il tuo logo o frasi in alta qualità.



SCHIZZI E CARATTERISTICHE DEI CAPI

100100 Pag. 153



- Capo in maglia.
- A coste su polsino e orlo.
- 2 tasche sui lati.
- Lunghezza circa: 68 cm.
- Capo M3: semi-aderente.

102500 Pag. 149



- Capo in maglia.
- A coste su polsino e orlo.
- 2 tasche frontali.
- Lunghezza circa: 66 cm.
- Capo M3: ampio.

102600 Pag. 149



- Capo in maglia.
- A coste su polsino e orlo.
- 2 tasche frontali.
- Lunghezza circa: 70 cm.
- Capo H3: ampio.

102700 Pag. 153



- Capo in maglia.
- A coste su polsino e orlo.
- 2 tasche sui lati.
- Lunghezza circa: 66 cm.
- Capo M2: semi-aderente.

102800 Pag. 151



- Capo in maglia spessa.
- A coste su polsino, scollo e orlo.
- Chiusura lampo frontale.
- Lunghezza circa: 66 cm.
- Capo H2: semi-aderente.

102900 Pag. 151



- Capo in maglia spessa.
- A coste su polsino, scollo e orlo.
- Chiusura lampo frontale.
- Lunghezza circa: 66 cm.
- Capo M2: semi-aderente.

103100 Pag. 150



- Capo in maglia fine.
- A coste su polsino e orlo.
- Chiusura lampo frontale.
- Lunghezza circa: 66 cm.
- Capo M2: semi-aderente.

103200 Pag. 150



- Capo in maglia fine.
- A coste su polsino, scollo e orlo.
- Chiusura lampo frontale.
- Lunghezza circa: 66 cm.
- Capo H2: semi-aderente.

103300 Pag. 152



- Capo in maglia spessa.
- A coste su polsino e orlo.
- Lunghezza circa: 73 cm.
- Capo aperto davanti.
- Capo M2: semi-aderente.

115000-115AT0 Pag. 210



- Capo UNISEX.
- Tessuto riccio e riccio-alta temperatura.
- Senza tasca.
- Lacci laterali regolabili.
- Lunghezza circa: 95 cm.

121300 Pag. 169



- Capo UNISEX.
- Taglie: - M 35/41. - L 42/46.

123000 Pag. 211



- Capo UNISEX.
- Materiale PVC.
- Cordino regolare.
- Senza tasca.
- Lunghezza circa: 110 cm.

124000 Pag. 211



- Capo UNISEX.
- Materiale PVC/cotone.
- Cordino regolabile.
- Senza tasca.
- Lunghezza circa: 90 cm.

125000 Pag. 210



- Capo UNISEX.
- Materiale polipropilene.
- Cordino regolabile.
- Senza tasca.
- Lunghezza circa: 90 cm.

126100 Pag. 213



- Capo UNISEX.
- Materiale nitrile.
- Bretelle regolabili.
- Senza tasche.
- Lunghezza circa: 115 cm.

126200 Pag. 212



- Capo UNISEX.
- Materiale elastomero.
- Bretelle regolabili.
- Senza tasche.
- Lunghezza circa: 115 cm.

126300 Pag. 213



- Capo UNISEX.
- Materiale vinile.
- Bretelle regolabili.
- Senza tasche.
- Lunghezza circa: 115 cm.

126400 Pag. 213



- Capo UNISEX.
- Materiale poliuretano.
- Bretelle regolabili.
- Senza tasche.
- Lunghezza circa: 115 cm.

126500 Pag. 214



- Capo UNISEX.
- Materiale poliuretano.
- Lacci laterali da annodare.
- Senza tasche.
- Lunghezza circa: 135 cm.

159700 Pag. 163
160100 Pag. 159



- Capo UNISEX.
- Materiale polipropilene.
- Cordino regolabile.
- Senza tasca.
- Lunghezza circa: 90 cm.

202100 Pag. 209



- Capo UNISEX.
- Lacci con elastico e bottoni automatici regolabili.
- 1 tasca interna frontale.
- Lunghezza circa: 86 cm.

203800 Pag. 178



- Cintura, bottone e chiusura lampo.
- 2 tasche stile jeans frontali e 2 a toppa posteriori.
- Lunghezza circa: 105 cm.
- Capo M1: aderente.

204000 Pag. 178



- Cintura, bottone e chiusura lampo.
- 2 tasche all'americana.
- Lunghezza circa: 105 cm.
- Capo M1: aderente.

212300 Pag. 163



- Capo UNISEX.
- Materiale propilene.
- Cordino regolabile.
- Senza tasca.
- Lunghezza circa: 90 cm.

212900 Pag. 204



- Tasca destra frontale.
- Lunghezza circa: 80 cm.
- Capo M2: ampio.

213100 Pag. 202



- Capo UNISEX.
- Lacci regolabili.
- 1 tasca a toppa frontale.
- Lunghezza circa: 80 cm.

357100 Pag. 133



- Capo per BAMBINI.
- Tasca sul torace sinistro.
- 2 tasche a toppa frontali.
- Lunghezza circa: T4: 65cm T8: 77cm T12: 85cm.

370100 Pag. 163



- Capo UNISEX.
- Senza tasca.
- Lunghezza circa: 40 cm.

400000-401000 Pag. 219
435000 Pag. 218



- Capo UNISEX.
- Retina nella parte superiore.
- Perimetro circa: TP: 54cm TM: 56cm TG: 58cm.

405000 Pag. 219
420000 Pag. 217
421000-410100 Pag. 217



- Capo UNISEX.
- Berretto regolabile.
- Rete posteriore con elastico.
- Contorno circa: 53 cm.

405100 Pag. 218



- Capo UNISEX.
- Rete posteriore con elastico.
- Perimetro circa: 53cm.

408000 Pag. 219



- Capo UNISEX.
- Coprinuca e paracollo.
- Lunghezza paracollo: 53 cm.

415000 Pag. 216
416000-410000 Pag. 217

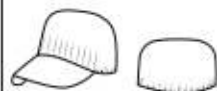

- Capo UNISEX.
- Berretto regolabile.
- Parte posteriore con elastico.
- Contorno circa: 53 cm.

422000 Pag. 217



- Capo UNISEX.
- Rete superiore.
- Parte posteriore con elastico.
- Pieghe frontali.
- Perimetro circa: 53 cm.

44000-491000 Pag. 218
449100 Pag. 218



- Capo UNISEX.
- Retina nella parte superiore.
- Bordino nella parte superiore.
- Perimetro circa: TP: 54cm TM: 56cm TG: 58cm.

H1 CAPI ADERENTI DA UOMO H2 CAPI SEMI-ADERENTI DA UOMO H3 CAPI AMPI DA UOMO

M1 CAPI ADERENTI DA DONNA M2 CAPI SEMI-ADERENTI DA DONNA M3 CAPI AMPI DA DONNA

445500 Pag. 161-166
447700 Pag. 161-166



- Capo UNISEX.
- Berretto regolabile.
- Due lacci da annodare.
- Riccio interno frontale.
- Contorno circa: 53 cm.

445600-445800 Pag. 167
450900 Pag. 158
447300 Pag. 162-167



- Capo UNISEX.
- Berretto unisex regolabile.
- Due lacci da annodare.
- Riccio interno frontale.
- Contorno circa: 53 cm

446100 Pag. 219



- Capo UNISEX.
- Regolabile a coste.
- Retina nella parte superiore.
- A coste: 4 cm di altezza.
- Contorno circa: 47 cm.

446200 Pag. 219



- Capo UNISEX.
- Regolabile con elastico.
- Retina nella parte superiore.
- Taglia unica.

447400 Pag. 162-167
447600 Pag. 166
445700-445900 Pag. 167
445400 Pag. 161
450800 Pag. 158



- Capo UNISEX chiuso.
- Elastico sulla parte posteriore.
- Riccio interno frontale.
- Taglia unica.

449500 Pag. 219

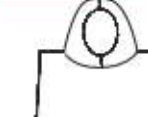

- Passamontagna UNISEX.
- Regolabile con elastico.
- Tessuto in rete bianca.
- Taglia unica.

449600 Pag. 219
450700 Pag. 156



- Passamontagna UNISEX.
- Regolabile con elastico sulla nuca.
- Tessuto in serge bianco.
- Taglia unica.

486000-486200 Pag. 210
486300 Pag. 156



- Capo UNISEX.
- Materiale: polipropilene/serge.
- Lunghezza circa: 45 cm.
- Lunghezza circa: 65cm.

520000 Pag. 190



- Pinces frontali e posteriori.
- Cintura posteriore.
- Polsini abbottonati.
- 1 taschino sinistro.
- 2 tasche a toppa frontali.
- Lunghezza circa: 95 cm.
- Capo M2: semi-aderente.

521000 Pag. 189
541000 Pag. 132



- Pinces frontali e posteriori.
- Cintura posteriore.
- 3 tasche a toppa frontali.
- Lunghezza circa: 95 cm.
- Capo M2: semi-aderente.

522000 Pag. 193
531000 Pag. 128
532000 Pag. 203



- Pinces frontali e posteriori.
- Cintura posteriore.
- 1 taschino sinistro.
- 2 tasche a toppa frontali.
- Lunghezza circa: 71 cm.
- Capo M2: semi-aderente.

530000 Pag. 128



- Pinces frontali e posteriori.
- Cintura posteriore.
- Polsini abbottonati.
- 1 taschino sinistro.
- 2 tasche a toppa frontali.
- Lunghezza circa: 71 cm.
- Capo M2: semi-aderente.

534000 Pag. 123



- Cuciture laterali frontali e posteriori.
- 1 taschino sinistro.
- 2 tasche a toppa frontali.
- 1 tasca dentro la tasca.
- Lunghezza circa: 65 cm.
- Capo M1: aderente

540000 Pag. 131
550000 Pag. 222



- Pinces frontali e posteriori.
- Cintura posteriore.
- Polsini abbottonati.
- 1 taschino sinistro.
- 2 tasche a toppa frontali.
- Lunghezza circa: 95 cm.
- Capo M2: semi-aderente.

542000 Pag. 134



- Cuciture laterali frontali e posteriori.
- 1 taschino sinistro.
- 2 tasche a toppa frontali.
- Manica 3/4, polsini aperti.
- Lunghezza circa: 95 cm.
- Capo M1: aderente.

542100 Pag. 134



- Cuciture laterali frontali e posteriori.
- 1 taschino sinistro.
- 2 tasche a toppa frontali.
- Polsini abbottonati.
- Lunghezza circa: 104 cm.
- Capo M1: aderente.

543000 Pag. 132



- Pinces frontali e posteriori.
- Cintura posteriore.
- 1 taschino sinistro.
- 2 tasche a toppa frontali.
- Lunghezza circa: 94 cm.
- Capo M2: semi-aderente.

556000 Pag. 147



- Pinces sul torace.
- Cintura posteriore.
- 1 taschino destro.
- 2 tasche a toppa frontali.
- Lunghezza circa: 93 cm.
- Capo M2: semi-aderente.

558000 Pag. 200



- Pinces frontali e posteriori.
- Cintura posteriore.
- 1 taschino destro.
- 2 tasche a toppa frontali.
- Lunghezza circa: 93 cm.
- Capo M2: semi-aderente.

561200 Pag. 187



- Pinces frontali e posteriori.
- Cintura posteriore.
- 1 taschino destro.
- 2 tasche a toppa frontali.
- Aperture laterali.
- Lunghezza circa: 71 cm.
- Capo M2: semi-aderente.

570000 Pag. 131
575000 Pag. 223



- Cuciture laterali posteriori.
- Cintura posteriore.
- 1 taschino destro.
- 2 tasche a toppa frontali.
- Maniche abbottonate.
- Lunghezza circa: 71 cm.
- Capo H3: ampio.

570100 Pag. 206



- Polsini in tessuto acrilico.
- Tasca interna sul torace.
- Collo con risvolto.
- Bottoni automatici nascosti.
- Lunghezza circa: 105 cm.
- Capo: H3 ampio.

570200 Pag. 206





















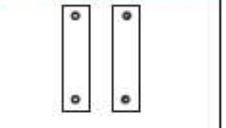











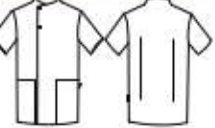







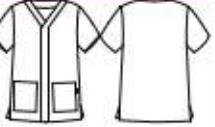





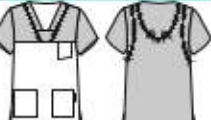

















- Polsini in tessuto acrilico.
- Tasca interna sul torace.
- Collo con risvolto.
- Chiusura con velcro.
- Lunghezza circa: 105 cm.
- Capo: H3 ampio.



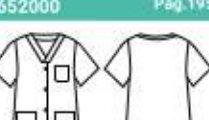













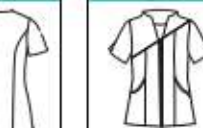













571000 Pag. 128





























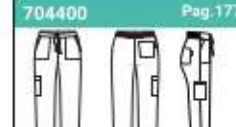

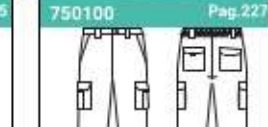
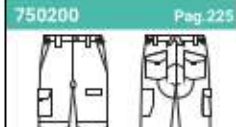

- Cintura posteriore.
- 1 taschino sinistro.
- Cucitura posteriore.
- 2 tasche a toppa frontali.
- Lunghezza circa: 103 cm.
- Capo H3: ampio.

<p>583600 Pág.161 599100 Pág.51 a 53</p>  <ul style="list-style-type: none"> - Pincés posteriori. - 1 taschino sinistro. - 2 tasche a toppa frontali. - Aperture laterali. - Lunghezza circa: 78 cm. - Capo H3: ampio 	<p>585000 Pág.220</p>  <ul style="list-style-type: none"> - Cintura posteriore. - 1 taschino sinistro. - 2 tasche a toppa frontali - Chiusura con bottoni in materiale plastico in vista. - Aperture laterali montate. - Lunghezza circa: 79 cm. - Capo H3: ampio. 	<p>595100 Pág.155</p>  <ul style="list-style-type: none"> - Capo UNISEX. - Taglia unica. - Laccio sul collo da annodare. - Senza tasche. - Lunghezza circa: 106 cm. - Capo: H3 ampio. 	<p>595200 Pág.156</p>  <ul style="list-style-type: none"> - Capo UNISEX. - Taglia unica. - Laccio sul collo da annodare. - Senza tasche. - Lunghezza circa: 110 cm. - Capo: H3 ampio. 	<p>600100 Pág.161</p>  <ul style="list-style-type: none"> - 1 taschino sinistro. - 2 tasche a toppa frontali. - Pincés sul torace e posteriori. - Cintura posteriore. - Lunghezza circa: 70 cm. - Capo M2: semi-aderente. 	<p>601000-603000 Pág.139 605000 Pág.136</p>  <ul style="list-style-type: none"> - 1 taschino sinistro. - 2 tasche a toppa frontali. - Aperture laterali. - Lunghezza circa: 74 cm. - Capo H3: ampio. 	<p>602000 Pág.141 604000 Pág.140-141 648000 Pág.196</p>  <ul style="list-style-type: none"> - Capo UNISEX. - Aperture laterali. - 1 tasca sul torace sinistro. - 2 tasche a toppa frontali. - Lunghezza circa: 74 cm. - Capo H3: ampio. 	<p>607200 Pág.125</p>  <ul style="list-style-type: none"> - Pincés sul torace e posteriori. - 1 tasca sul torace sinistro. - 2 tasche a toppa frontali. - Aperture laterali. - Lunghezza circa: 71 cm. - Capo M3: aderente.
<p>607300 Pág.124</p>  <ul style="list-style-type: none"> - Cuciture laterali frontali. - Pincés posteriori. - 2 tasche tra le cuciture laterali. - Bottoni automatici nascosti. - Passanti intercambiabili. - Lunghezza circa: 66 cm. - Capo M2: semi-aderente. 	<p>607400 Pág.119</p>  <ul style="list-style-type: none"> - Cuciture laterali frontali. - Cucitura centrale posteriore. - 2 tasche tra le cuciture laterali. - Bottoni automatici nascosti. - Passanti intercambiabili. - Lunghezza circa: 71 cm. - Capo M2: semi-aderente. 	<p>607700 Pág.130</p>  <ul style="list-style-type: none"> - Pincés frontali e posteriori. - Passante posteriore. - 3 tasche nascoste. - Bottoni automatici nascosti. - Polsini con bottone automatico. - Lunghezza circa: 93,5 cm. - Capo M2: semi-aderente. 	<p>608200 Pág.119</p>  <ul style="list-style-type: none"> - Capo UNISEX. - Passanti intercambiabili. 	<p>608300 Pág.207</p>  <ul style="list-style-type: none"> - Capo UNISEX. - Polsini in tessuto acrilico. - Taschino nascosto. - Aperture laterali. - Lunghezza circa: 74 cm. - Capo H3: ampio. 	<p>609300 Pág.192</p>  <ul style="list-style-type: none"> - Pincés frontali-posteriori. - 2 tasche tra le cuciture. - Cintura posteriore. - Bottoni in materiale plastico in vista. - Lunghezza circa: 71 cm. - Capo H2: semi-aderente. 	<p>609600 Pág.86-88</p>  <ul style="list-style-type: none"> - Capo UNISEX. - 2 tasche a toppa frontali. - Aperture laterali. - Lunghezza circa: 74 cm. - Capo H2: semi-aderente. 	<p>609900 Pág.199</p>  <ul style="list-style-type: none"> - Cuciture laterali frontali-posteriori. - 2 tasche tra le cuciture. - Bottoni in materiale plastico in vista. - Lunghezza circa: 72 cm. - Capo M2: semi-aderente.
<p>610100 Pág.119</p>  <ul style="list-style-type: none"> - Pincés frontali. - 2 tasche tra le pincés. - Passanti intercambiabili. - Bottoni automatici nascosti. - Lunghezza circa: 77 cm. - Capo H2: semi-aderente. 	<p>610200 Pág.124</p>  <ul style="list-style-type: none"> - Pincés posteriori. - 2 tasche a toppa sui fianchi. - Bottoni automatici nascosti. - Lunghezza circa: 74 cm. - Capo H2: semi-aderente. 	<p>610300 Pág.130</p>  <ul style="list-style-type: none"> - 3 tasche nascoste con patta. - Bottoni automatici nascosti. - Polsini con automatici. - Lunghezza circa: 98 cm. - Capo H2: semi-aderente. 	<p>611300 Pág.160 614800 Pág.163 611400 Pág.21 a 30</p>  <ul style="list-style-type: none"> - Capo UNISEX. - Pincés posteriori. - 1 tasca ad asola sul torace. - 1 tasca ad asola sul fianco destro. - Aperture laterali. - Lunghezza circa: 73 cm. - Capo H2: semi-aderente. 	<p>611500 Pág.159 370100 Pág.163</p>  <ul style="list-style-type: none"> - Capo UNISEX. - Pincés posteriori. - 1 tasca ad asola sul torace. - 1 tasca ad asola sul fianco destro. - Aperture laterali. - Lunghezza circa: 73 cm. - Capo H2: semi-aderente. 	<p>611700 Pág.51 a 53 611800 Pág.47 a 49</p>  <ul style="list-style-type: none"> - Capo UNISEX. - Pincés posteriori. - 1 tasca ad asola sul torace. - 1 tasca ad asola sul fianco destro. - Aperture laterali. - Lunghezza circa: 73 cm. - Capo H2: semi-aderente. 	<p>612300 Pág.112</p>  <ul style="list-style-type: none"> - Pincés posteriori. - Tasca sul fianco destro. - Lunghezza circa: 74 cm. - Capo H2: semi-aderente. 	<p>612500 Pág.91</p>  <ul style="list-style-type: none"> - Pincés posteriori. - 2 tasche a toppa frontali. - Bottoni automatici nascosti. - Lunghezza circa: 76 cm. - Capo H2: semi-aderente.
<p>612600 Pág.93</p>  <ul style="list-style-type: none"> - Pincés posteriori. - 2 tasche a toppa frontali. - Bottoni automatici nascosti. - Aperture laterali. - Lunghezza circa: 74 cm. - Capo H2: semi-aderente. 	<p>612900 Pág.67</p>  <ul style="list-style-type: none"> - Capo slim-fit. - Pincés posteriori. - 2 tasche a toppa frontali. - Tasca invisibile sul torace sinistro. - Aperture laterali. - Lunghezza circa: 74 cm. - Capo H2: semi-aderente. 	<p>613100 Pág.112</p>  <ul style="list-style-type: none"> - Pincés posteriori. - 2 tasche a toppa frontali. - Bottoni automatici nascosti. - Aperture laterali. - Lunghezza circa: 74 cm. - Capo H2: semi-aderente. 	<p>613200 Pág.55</p>  <ul style="list-style-type: none"> - Pincés posteriori. - 2 tasche a toppa frontali. - Tasca invisibile sul torace sinistro. - Aperture laterali. - Lunghezza circa: 74 cm. - Capo H2: semi-aderente. 	<p>613900 Pág.69</p>  <ul style="list-style-type: none"> - Cuciture laterali frontali-posteriori. - Pincés frontali. - 2 tasche frontali. - 1 taschino. - Bottoni automatici nascosti. - Lunghezza circa: 74 cm. - Capo H2: semi-aderente. 	<p>614000 Pág.144</p>  <ul style="list-style-type: none"> - Capo per gravidanza. - Pincés posteriori. - Vita alta con pieghe frontali. - Lacci posteriori regolabili. - Lunghezza circa: 68 cm. - Capo M2: semi-aderente. 	<p>614100 Pág.109</p>  <ul style="list-style-type: none"> - Pincés frontali. - Cuciture laterali frontali-posteriori. - 2 tasche a toppa frontali. - Bottoni automatici nascosti. - Collo alla coreana. - Lunghezza circa: 75 cm. - Capo H2: semi-aderente. 	<p>615200 Pág.33</p>  <ul style="list-style-type: none"> - 2 tasche a toppa frontali. - Aperture laterali. - Bottoni automatici nascosti. - Lunghezza circa: 74 cm. - Capo H3: ampio.

<p>615400 Pág.116</p>  <ul style="list-style-type: none"> - Dettaglio del tessuto AEROSILVER. - Cuciture laterali frontali e posteriori. - 2 tasche tra le cuciture laterali. - Lunghezza circa: 73 cm. - Capo H1: ampio. 	<p>615500 Pág.93</p>  <ul style="list-style-type: none"> - Pincés posteriori. - 2 tasche a toppa frontali. - Bottoni automatici nascosti. - Aperture laterali. - Lunghezza circa: 74 cm. - Capo H2: semi-aderente. 	<p>615600 Pág.91</p>  <ul style="list-style-type: none"> - Pincés posteriori. - 2 tasche a toppa frontali. - Bottoni automatici - Lunghezza circa: 75 cm. - Capo H2: semi-aderente. 	<p>615700 Pág.115</p>  <ul style="list-style-type: none"> - Dettaglio del tessuto: TECNICO TRASPIRANTE. - Aperture laterali. - 2 tasche a toppa frontali. - 1 taschino nascosto. - Lunghezza circa: 76 cm. - Capo H1: ampio. 	<p>615800 Pág.102</p>  <ul style="list-style-type: none"> - Dettaglio del tessuto COOLMAX. - Aperture laterali. - 2 tasche a toppa frontali. - Pincés posteriori. - Tasca posteriore. - Lunghezza circa: 74 cm. - Capo H2: semi-aderente. 	<p>615900 Pág.101</p>  <ul style="list-style-type: none"> - Dettaglio del tessuto COOLMAX. - Aperture laterali. - 2 tasche ad asola frontali. - Carré sulla schiena. - Collo alla coreana. - Lunghezza circa: 74 cm. - Capo H1: ampio. 	<p>616100 Pág.105</p>  <ul style="list-style-type: none"> - Dettaglio del tessuto COOLMAX. - 3 tasche, 1 sul torace. - Bottoni nascosti. - Collo alla coreana. - Polsini con bottone automatico. - Lunghezza circa: 98 cm. - Capo H1: ampio. 	<p>616200 Pág.106</p>  <ul style="list-style-type: none"> - Dettaglio del tessuto COOLMAX. - 2 tasche ad asola frontali. - Bottoni nascosti. - Polsini con bottone automatico. - Aperture laterali. - Lunghezza circa: 74 cm. - Capo H1: ampio.
<p>616300 Pág.70</p>  <ul style="list-style-type: none"> - Dettagli in AEROSILVER. - Collo alla coreana. - 2 tasche frontali. - Bottoni nascosti. - Aperture laterali. - Lunghezza circa: 74 cm. - Capo H1: ampio. 	<p>616500 Pág.40-41</p>  <ul style="list-style-type: none"> - Collo alla coreana. - 2 tasche frontali. - Bottoni nascosti. - Polsini con bottoni automatici - Pincés posteriori. - Lunghezza circa: 74 cm. - Capo H2: semi-aderente. 	<p>616600 Pág.43</p>  <ul style="list-style-type: none"> - Collo alla coreana. - 2 tasche frontali. - Chiusura lampo frontale. - Aperture laterali. - Pincés posteriori. - Lunghezza circa: 73 cm. - Capo H2: semi-aderente. 	<p>616700-617800 Pág.56 Pág.60</p>  <ul style="list-style-type: none"> - Dettaglio del tessuto COOLMAX. - Cuciture laterali frontali e posteriori. - 2 tasche frontali. - Aperture laterali. - Tasca sul lato destro. - Lunghezza circa: 74 cm. - Capo H1: ampio. 	<p>616800 Pág.38</p>  <ul style="list-style-type: none"> - Dettaglio del tessuto COOLMAX. - Cuciture laterali frontali-posteriori. - 2 tasche nelle cuciture laterali - Carré sulla schiena. - Lunghezza circa: 73 cm. - Capo H1: ampio. 	<p>616900 Pág.97</p>  <ul style="list-style-type: none"> - Cuciture laterali frontali. - Pincés posteriori. - Tasca con chiusura lampo frontale. - 2 tasche tra le cuciture laterali. - Aperture laterali. - Lunghezza circa: 74 cm. - Capo H2: semi-aderente. 	<p>617100 Pág.77</p>  <ul style="list-style-type: none"> - Dettaglio del tessuto AEROSILVER. - 2 tasche a toppa frontali. - 1 tasca ad asola sul torace. - Bottoni nascosti. - Collo alla coreana. - Lunghezza circa: 97 cm. - Capo H1: ampio. 	<p>617200 Pág.83</p>  <ul style="list-style-type: none"> - 2 tasche frontali. - 1 tasca ad asola sul torace. - Elastico sull'avambraccio. - Bottoni nascosti. - Collo alla coreana. - Lunghezza circa: 98 cm. - Capo H1: ampio.
<p>617300 Pág.120</p>  <ul style="list-style-type: none"> - Polsini con bottoni automatici nascosti. - Bottoni nascosti. - Passante posteriore. - Triangolo-cintura intercambiabili. - Lunghezza circa: 98 cm. - Capo H2: semi-aderente. 	<p>617500 Pág.10</p>  <ul style="list-style-type: none"> - Tessuto 360°. - 3 tasche a toppa frontali. - Cuciture laterali frontali-posteriori. - Lunghezza circa: 74 cm. - Capo H1: ampio. 	<p>617600 Pág.111</p>  <ul style="list-style-type: none"> - 2 tasche frontali. - Pincés posteriori. - Carré frontale. - Lunghezza circa: 74 cm. - Capo H1: ampio. 	<p>617700 Pág.17</p>  <ul style="list-style-type: none"> - Tessuto 360°. Capo UNISEX. - 2 tasche frontali. - Cuciture laterali posteriori. - Aperture laterali. - Manica raglan. - Lunghezza circa: 82 cm. - Capo H1: ampio. 	<p>617900 Pág.126</p>  <ul style="list-style-type: none"> - 2 tasche frontali. - 1 tasca a toppa sul torace. - Bottoni automatici nascosti. - Aperture laterali. - Lunghezza circa: 74 cm. - Capo H1: ampio. 	<p>618100-618200 Pág.121</p>  <ul style="list-style-type: none"> - Opzioni di colore: - Per 661900-617300 - Taglie: P/M/G 	<p>623500 Pág.142</p>  <ul style="list-style-type: none"> - Cuciture laterali frontali. - Manica corta, apertura posteriore. - Pincés posteriori e apertura. - 2 tasche nelle cuciture laterali - Chiusura lampo centrale. - Lunghezza circa: 75 cm. - Capo M2: semi-aderente. 	<p>623600 Pág.143</p>  <ul style="list-style-type: none"> - Cuciture laterali frontali. - Manica lunga, apertura posteriore. - Pincés posteriori e apertura. - 2 tasche tra le cuciture laterali. - Chiusura lampo centrale. - Lunghezza circa: 75 cm. - Capo M2: semi-aderente.
<p>647000 Pág.194</p>  <ul style="list-style-type: none"> - 1 taschino sinistro. - 2 tasche a toppa frontali. - Aperture laterali. - Lunghezza circa: 78 cm. - Capo H3: ampio. 	<p>650000 Pág.127</p>  <ul style="list-style-type: none"> - Capo UNISEX. - Bottoni in materiale plastico in vista. - 2 tasche frontali. - 1 taschino. - Lunghezza circa: 74 cm. - Capo H3: ampio. 	<p>652000 Pág.195</p>  <ul style="list-style-type: none"> - Bottoni in materiale plastico in vista. - 2 tasche frontali. - 1 taschino. - Lunghezza circa: 74 cm. - Capo M3: ampio. 	<p>655100 Pág.92</p>  <ul style="list-style-type: none"> - Bottoni automatici nascosti. - Pincés torace. - Pincés frontali-posteriori. - 2 tasche frontali. - Lunghezza circa: 72 cm. - Capo M2: semi-aderente. 	<p>655200 Pág.90</p>  <ul style="list-style-type: none"> - Bottoni automatici nascosti. - Pincés posteriori. - Cuciture laterali frontali. - Tasche tra le cuciture laterali. - Lunghezza circa: 73 cm. - Capo M2: semi-aderente. 	<p>656200 Pág.112</p>  <ul style="list-style-type: none"> - Pincés sul torace e posteriori. - Cucitura sul lato destro. - Tasca sul fianco destro. - Lunghezza circa: 65 cm. - Capo M2: semi-aderente. 	<p>656400 Pág.112</p>  <ul style="list-style-type: none"> - Bottoni automatici nascosti. - Pincés sul torace e posteriori. - Tasca sul fianco destro. - Lunghezza circa: 72 cm. - Capo M2: semi-aderente. 	<p>656500 Pág.55</p>  <ul style="list-style-type: none"> - Capo slim-fit. - 2 tasche sui fianchi. - 1 taschino nascosto. - Pincés sul torace e posteriori. - Aperture laterali. - Lunghezza circa: 67 cm. - Capo M1: aderente.

<p>657200 Pag.146</p>  <ul style="list-style-type: none"> - Cuciture laterali frontali-posteriori. - 2 tasche a toppa sui fianchi. - 1 tasca a toppa sul torace. - Automatici in vista. - Lunghezza circa: 72 cm. - Capo M2: semi-aderente. 	<p>657300 Pag.66</p>  <ul style="list-style-type: none"> - Capo slim-fit. - Taschino nascosto. - Pincés sul torace e posteriori. - 2 tasche con bordino sui fianchi. - Lunghezza circa: 67 cm. - Capo M1: aderente. 	<p>657400 Pag.109</p>  <ul style="list-style-type: none"> - Cuciture laterali frontali-posteriori. - 2 tasche tra le cuciture laterali. - Bottoni automatici nascosti. - Maniche: aperture centrali. - Lunghezza circa: 72 cm. - Capo M2: semi-aderente. 	<p>657500 Pag.108</p>  <ul style="list-style-type: none"> - Pincés sul torace e posteriori. - Bottoni automatici in vista. - Lunghezza circa: 67 cm. - Capo M2: semi-aderente. 	<p>658100 Pag.69</p>  <ul style="list-style-type: none"> - Polsini con bottone automatico nascosto. - Cuciture laterali frontali-posteriori. - 1 tasca a toppa sul torace. - Bottoni automatici nascosti. - Lunghezza circa: 72 cm. - Capo M2: semi-aderente. 	<p>658400 Pag.34</p>  <ul style="list-style-type: none"> - Cuciture laterali frontali-posteriori. - 1 tasca con cucitura laterale frontale. - 1 tasca con fantasia di cucitura laterale - Aperture laterali. - Lunghezza circa: 67 cm. - Capo M2: semi-aderente. 	<p>658500 Pag.116</p>  <ul style="list-style-type: none"> - Cuciture laterali frontali-posteriori. - 2 tasche a toppa frontali. - Aperture laterali. - Lunghezza circa: 67 cm. - Capo M2: semi-aderente. 	<p>658600 Pag.43</p>  <ul style="list-style-type: none"> - Chiusura lampo centrale. - Cuciture laterali frontali. - 2 tasche tra le cuciture laterali. - Pincés posteriori. - Aperture centrali sulle maniche - Lunghezza circa: 74 cm. - Capo M2: semi-aderente.
<p>658700 Pag.56 662400 Pag.60</p>  <ul style="list-style-type: none"> - Dettaglio del tessuto AEROSILVER. - 2 tasche a toppa frontali. - Tasca nella cucitura laterale destra. - Aperture laterali. - Lunghezza circa: 66 cm. - Capo M2: semi-aderente. 	<p>658800 Pag.38</p>  <ul style="list-style-type: none"> - Dettaglio del tessuto COOLMAX. - Cucitura laterale frontale e posteriore. - 2 tasche nelle cuciture laterali - Pincés sul torace. - Lunghezza circa: 68 cm. - Capo M2: semi-aderente. 	<p>658900 Pag.115</p>  <ul style="list-style-type: none"> - Dettagli del tessuto tecnico TRASPIRANTE. - 2 tasche nelle cuciture laterali - 1 tasca ad asola sul torace sinistro. - Lunghezza circa: 66 cm. - Capo M2: semi-aderente. 	<p>659400 Pag.92</p>  <ul style="list-style-type: none"> - Pincés frontali-posteriori. - 2 tasche a toppa frontali. - Pincés sul torace. - Aperture laterali. - Lunghezza circa: 70 cm. - Capo M2: semi-aderente. 	<p>659500 Pag.90</p>  <ul style="list-style-type: none"> - Cuciture laterali frontali. - Pincés posteriori. - 2 tasche tra le cuciture laterali. - Bottoni automatici nascosti. - Lunghezza circa: 73 cm. - Capo M2: semi-aderente. 	<p>659600 Pag.7</p>  <ul style="list-style-type: none"> - Tessuto 360°. - Cuciture laterali frontali-posteriori. - 2 tasche a toppa frontali. - Pincés sul torace. - Aperture laterali. - Lunghezza circa: 66 cm. - Capo M2: semi-aderente. 	<p>659700 Pag.102</p>  <ul style="list-style-type: none"> - Dettaglio del tessuto COOLMAX. - Cuciture laterali frontali-posteriori. - 2 tasche a toppa frontali. - Aperture laterali. - Lunghezza circa: 65 cm. - Capo M2: semi-aderente. 	<p>659800 Pag.101</p>  <ul style="list-style-type: none"> - Dettaglio del tessuto COOLMAX. - Cuciture laterali frontali-posteriori. - 2 tasche tra le cuciture laterali - Pincés sul torace. - Bottoni automatici nascosti. - Lunghezza circa: 70 cm. - Capo M2: semi-aderente.
<p>659900 Pag.104</p>  <ul style="list-style-type: none"> - Dettaglio del tessuto COOLMAX. - 3 tasche a toppa frontali. - Piega posteriore. - Polsini abbottonati. - Bottoni automatici nascosti. - Lunghezza circa: 87 cm. - Capo M2: semi-aderente. 	<p>660500 Pag.40-41</p>  <ul style="list-style-type: none"> - Pincés frontali e posteriori. - 2 tasche a toppa frontali. - Pincés sul torace. - Polsini abbottonati sulle maniche. - Lunghezza circa: 70 cm. - Capo M2: semi-aderente. 	<p>660600 Pag.106</p>  <ul style="list-style-type: none"> - Dettaglio del tessuto COOLMAX. - 2 tasche nelle cuciture laterali - Pincés sul torace. - Polsini abbottonati. - Bottoni automatici nascosti. - Lunghezza circa: 70 cm. - Capo M2: semi-aderente. 	<p>660700 Pag.37</p>  <ul style="list-style-type: none"> - Cuciture laterali frontali-posteriori. - 4 tasche a toppa frontali. - Pincés sul torace. - Lunghezza circa: 65 cm. - Capo M2: semi-aderente. 	<p>660800 Pag.71</p>  <ul style="list-style-type: none"> - Dettaglio del tessuto AEROSILVER. - Cuciture laterali frontali. - 2 tasche tra le cuciture laterali - Pincés posteriori. - Bottoni automatici nascosti. - Lunghezza circa: 71 cm. - Capo M2: semi-aderente. 	<p>660900 Pag.78</p>  <ul style="list-style-type: none"> - Pincés frontali-posteriori. - 2 tasche a toppa frontali. - Pincés posteriori. - Cintura posteriore. - Bottoni automatici nascosti. - Lunghezza circa: 80 cm. - Capo M2: semi-aderente. 	<p>661100 Pag.74</p>  <ul style="list-style-type: none"> - Dettaglio del tessuto AEROSILVER. - 2 tasche tra le cuciture laterali - Piega posteriore. - Bottoni automatici nascosti. - Lunghezza circa: 82 cm. - Capo M2: semi-aderente 	<p>661200 Pag.82</p>  <ul style="list-style-type: none"> - Piega posteriore. - Cintura posteriore. - 2 tasche tra le cuciture laterali - Bottoni automatici nascosti. - Lunghezza circa: 80 cm. - Capo M2: semi-aderente.
<p>661300 Pag.83</p>  <ul style="list-style-type: none"> - Cuciture laterali frontali-posteriori. - 2 tasche tra le cuciture laterali. - Bottoni automatici nascosti. - Lunghezza circa: 80 cm. - Capo M2: semi-aderente. 	<p>661400 Pag.97</p>  <ul style="list-style-type: none"> - Cuciture laterali frontali-posteriori. - 2 tasche tra le cuciture laterali - 1 tasca con chiusura lampo destra. - Aperture laterali. - Lunghezza circa: 67 cm. - Capo M2: semi-aderente. 	<p>661500 Pag.123</p>  <ul style="list-style-type: none"> - Cuciture laterali frontali. - Pincés posteriori. - 2 tasche a toppa frontali. - Bottoni automatici nascosti. - Lunghezza circa: 67 cm. - Capo M2: semi-aderente. 	<p>661600 Pag.65</p>  <ul style="list-style-type: none"> - Cuciture laterali frontali. - 2 tasche tra le cuciture laterali. - Pincés posteriori. - Lacci regolabili. - Lunghezza circa: 67 cm. - Capo M2: semi-aderente 	<p>661700 Pag.122</p>  <ul style="list-style-type: none"> - Cuciture laterali frontali-posteriori. - 2 tasche tra le cuciture laterali. - Cintura posteriore. - Bottoni automatici. - Lunghezza circa: 70 cm. - Capo M2: semi-aderente. 	<p>661800 Pag.45</p>  <ul style="list-style-type: none"> - Cuciture laterali frontali-posteriori. - 2 tasche tra le cuciture laterali. - Bottoni automatici nascosti. - Lunghezza circa: 70 cm. - Capo M2: semi-aderente. 	<p>661900 Pag.120</p>  <ul style="list-style-type: none"> - Cuciture laterali posteriori. - 2 tasche a toppa frontali. - Cintura posteriore. - Bottoni automatici nascosti. - Pincés sul torace. - Polsini con bottoni automatici. - Lunghezza circa: 72 cm. - Capo M2: semi-aderente. 	<p>662100 Pag.14</p>  <ul style="list-style-type: none"> - Cuciture laterali frontali. - Pincés posteriori. - Tasca sulla cucitura laterale. - Pincés sul torace. - Lunghezza circa: 64 cm. - Capo M2: semi-aderente

<p>662200 Pag.18</p>  <ul style="list-style-type: none"> - Tessuto 360°. - Cuciture laterali frontali. - Pincos posteriori. - Tasche tra le cuciture laterali. - Chiusura lampo centrale. - Maniche con aperture. - Dimensioni circa: 74 cm. - Capo M2: semi-aderente. 	<p>662300 Pag.111</p>  <ul style="list-style-type: none"> - Cuciture laterali posteriori. - Pincos sul torace. - Tasche a toppa frontali. - Carré frontale. - Aperture laterali. - Dimensioni circa: 65 cm. - Capo M2: semi-aderente. 	<p>662500 Pag.62</p>  <ul style="list-style-type: none"> - Cuciture laterali frontali. - Pincos posteriori. - Tasche tra le cuciture laterali. - Bottoni automatici nascosti. - Dimensioni circa: 72 cm. - Capo M2: semi-aderente. 	<p>662600 Pag.201</p>  <ul style="list-style-type: none"> - Cucitura laterale frontale destra. - Pincos sul torace. - Lacci regolabili posteriori. - Lunghezza circa: 65 cm. - Capo M2: semi-aderente. 	<p>662700 Pag.199</p>  <ul style="list-style-type: none"> - Cuciture laterali frontali. - Pincos posteriori. - Tasche tra le cuciture laterali. - Bottoni automatici nascosti. - Passamaneria su maniche, tasche e cintura posteriore. - Lunghezza circa: 70 cm. - Capo M2: semi-aderente. 	<p>662800 Pag.126</p>  <ul style="list-style-type: none"> - Taschino sinistro. - 2 tasche a toppa frontali. - Pincos posteriori. - Bottoni automatici nascosti. - Lunghezza circa: 70 cm. - Capo M2: semi-aderente. 	<p>700500 Pag.185 700600 Pag.172</p>  <ul style="list-style-type: none"> - Capo UNISEX. - Cordino elasticizzato con estremità. - Elastico sul girovita da 4 cm. - 2 tasche interne sui fianchi. - 1 tasca a toppa posteriore. - Lunghezza circa: 110 cm. - Capo H2: semi-aderente. 	<p>700800 Pag.207</p>  <ul style="list-style-type: none"> - Capo UNISEX. - Elastico sul girovita da 4cm. - Cordino interno regolabile. - Tasca interna sul fianco destro. - Lunghezza circa: 110 cm. - Capo H2: semi-aderente.
<p>702400 Pag.173</p>  <ul style="list-style-type: none"> - Capo UNISEX. - Elastico sul girovita posteriore. - Cordino elasticizzato con estremità. - Tasca all'americana destra. - Orlo stretto. - Lunghezza circa: 106 cm. - Capo H2: semi-aderente. 	<p>702500(H) Pag.179 703700(M) Pag.176</p>  <ul style="list-style-type: none"> - Elastico sul girovita posteriore. - Cordino elasticizzato regolabile. - 1 tasca a toppa posteriore. - 2 tasche alla francese-lati. - Orlo stretto. - Lunghezza circa: 106 cm. - Capo H2: semi-aderente. 	<p>702600 Pag.177 703600 Pag.49 704900 Pag.177</p>  <ul style="list-style-type: none"> - Capo UNISEX. - Elastico sul girovita posteriore. - Cordino elasticizzato con estremità. - 1 tasca a toppa posteriore. - 2 tasche alla francese-lati. - Lunghezza circa: 110 cm. - Capo H2: semi-aderente. 	<p>702700 Pag.178</p>  <ul style="list-style-type: none"> - Capo UNISEX. - Orlo stretto. - Elastico sul girovita posteriore. - Cordino regolabile. - 1 tasca a toppa posteriore. - 2 tasche alla francese-lati. - Lunghezza circa: 105 cm. - Capo H2: semi-aderente. 	<p>702800 Pag.176</p>  <ul style="list-style-type: none"> - Capo UNISEX. - Orlo stretto. - Elastico sul girovita posteriore. - Cordino regolabile. - 1 tasca invisibile posteriore. - 2 tasche tipo jeans-lati. - Lunghezza circa: 105 cm. - Capo H2: semi-aderente. 	<p>702900 Pag.181</p>  <ul style="list-style-type: none"> - Capo UNISEX. - Orlo stretto. - Elastico sul girovita posteriore. - Cordino regolabile. - 1 tasca invisibile posteriore. - 2 tasche tipo jeans sul lati. - Lunghezza circa: 105 cm. - Capo H2: semi-aderente. 	<p>703100 Pag.185</p>  <ul style="list-style-type: none"> - Capo UNISEX. - Orlo stretto. - Elastico sul girovita posteriore. - Cordino regolabile. - 1 tasca a toppa sulla gamba destra. - 2 tasche tipo jeans sul lati. - Lunghezza circa: 105 cm. - Capo H2: semi-aderente. 	<p>703800 Pag.179</p>  <ul style="list-style-type: none"> - Capo UNISEX. - Elastico sul girovita posteriore. - Cordino elasticizzato regolabile. - 1 tasca a toppa posteriore. - 2 tasche tipo jeans sul lati. - 1 tasca sulla gamba sinistra. - Lunghezza circa: 105 cm. - Capo H2: semi-aderente.
<p>704200 Pag.178</p>  <ul style="list-style-type: none"> - Capo UNISEX. - Elastico sul girovita posteriore. - Cordino regolabile-estremità. - 1 tasca a toppa posteriore. - 2 tasche alla francese-lati. - 2 tasche sulle gambe. - Orlo stretto elasticizzato. - Lunghezza circa: 106 cm. - Capo H2: semi-aderente. 	<p>704300 Pag.107</p>  <ul style="list-style-type: none"> - Capo UNISEX. - Orlo stretto. - Elastico sul girovita posteriore. - Cordino regolabile. - 1 tasca a toppa posteriore. - 2 tasche alla francese-lati. - 2 tasche sui lati. - 2 tasche sulle gambe. - Lunghezza circa: 106 cm. - Capo H2: semi-aderente. 	<p>704400 Pag.177</p>  <ul style="list-style-type: none"> - Elastico sul girovita posteriore. - Cordino regolabile. - 1 tasca a toppa posteriore. - 2 tasche alla francese-lati. - 1 tasca sulla gamba destra. - Orlo stretto. - Lunghezza circa: 105 cm. - Capo M2: semi-aderente. 	<p>704500 Pag.181</p>  <ul style="list-style-type: none"> - Capo UNISEX. - Orlo stretto. - Elastico sul girovita posteriore. - Cordino regolabile. - 1 tasca con chiusura lampo posteriore. - 2 tasche sui lati. - Rinforzo sulle ginocchia. - Lunghezza circa: 106 cm. - Capo H2: semi-aderente. 	<p>704600 Pag.180</p>  <ul style="list-style-type: none"> - Dettaglio del tessuto VIGORÉ. - Capo UNISEX. - Orlo stretto. - Elastico sul girovita posteriore. - Cordino regolabile. - 2 tasche alla francese-lati. - Lunghezza circa: 106 cm. - Capo H2: semi-aderente. 	<p>704700 Pag.174</p>  <ul style="list-style-type: none"> - Capo UNISEX. - Elastico sul girovita posteriore. - Cordino regolabile. - 1 tasca a toppa posteriore. - 2 tasche alla francese-lati. - Orlo stretto elasticizzato. - Lunghezza circa: 106 cm. - Capo H2: semi-aderente. 	<p>704800 Pag.175</p>  <ul style="list-style-type: none"> - Capo UNISEX. - Orlo stretto. - Elastico sul girovita posteriore. - Cordino regolabile. - 2 tasche tipo jeans frontali. - Lunghezza circa: 106 cm. - Capo H2: semi-aderente. 	<p>750100 Pag.227</p>  <ul style="list-style-type: none"> - Capo UNISEX. - Multitasche. - Elastico sul girovita posteriore. - Passanti sulla vita. - 2 tasche alla francese-lati. - 4 tasche a toppa. - Lunghezza circa: 108 cm. - Capo H2: semi-aderente.
<p>750200 Pag.225</p>  <ul style="list-style-type: none"> - Capo UNISEX, multitasche. - Elastico sui lati. - 2 tasche alla francese-lati. - 2 tasche alla francese-lati. - 4 tasche a toppa. - Rinforzo sul cavallo. - Lunghezza circa: 108 cm. - Capo H2: semi-aderente. 	<p>772000 Pag.185 77300-773300 Pag.184</p>  <ul style="list-style-type: none"> - Capo UNISEX. - Elastico sul girovita posteriore. - Chiusura lampo e bottone frontale. - 2 tasche alla francese-lati. - Lunghezza circa: 110 cm. - Capo H2: semi-aderente. 	<p>772G00 Pag.139-182 773G00 Pag.182 7733G0 Pag.183</p>  <ul style="list-style-type: none"> - Capo UNISEX. - Elastico sul girovita posteriore. - Cordino elasticizzato con estremità. - 1 tasca a toppa posteriore. - 2 tasche alla francese-lati. - Lunghezza circa: 110 cm. - Capo H2: semi-aderente. 	<p>772500 Pag.173</p>  <ul style="list-style-type: none"> - Capo per GRAVIDANZA. - Elastico in tessuto acrilico sul ventre. - Regolabile con elastico interno. - 2 tasche alla francese. - Lunghezza circa: 113 cm. - Capo M2: semi-aderente. 	<p>840000-843000 Pag.138</p>  <ul style="list-style-type: none"> - Completo UNISEX: - Pantaloni 773000. - Blusa 603000. - Pantaloni con elastico posteriore e tasche alla francese. - Chiusura lampo e bottone frontale. - Blusa con 3 tasche a toppa e aperture laterali. - Capo H3: ampio. 	<p>841100 Pag.138</p>  <ul style="list-style-type: none"> - Completo UNISEX: - Pantaloni 772G00. - Blusa 601000. - Pantaloni con elastico e tasche alla francese. - Blusa con 3 tasche a toppa. - Capo H3: ampio. 	<p>841500 Pag.154 845100 Pag.155</p>  <ul style="list-style-type: none"> - Completo UNISEX: - 841500 completo per bambini. - 845100 completo per adulti - Pantaloni con laccio da annodare. - Blusa con bottoni in materiale plastico. - Blusa con 3 tasche a toppa. - Capo H3: ampio. 	<p>842000 Pag.141 844000</p>  <ul style="list-style-type: none"> - Completo UNISEX: - Pantaloni 772000. - Blusa 602000. - Pantaloni con elastico posteriore e tasche. - Chiusura lampo e bottone. - Blusa con bottoni in materiale plastico in vista. - Capo H3: ampio.

Misure

Queste misure vengono prese sulla persona per assegnare la taglia appropriata.



CM.		MISURE BASE DONNA: CAPI SUPERIORI E PANTALONI															
TAGLIE	P						M			G				SG			
	XSS	XS		S			M		L	XL		XXL		YL			
	34	36	38	40	42	44	46	48	50	52	54	56	58	60	62	64	
TORACE	78-81	82-85	86-90	90-93	94-97	98-101	12-105	106-109	110-113	114-117	118-121	122-125	126-129	130-133	134-137	138-141	
VITA	60	64	68	72	76	80	84	88	92	96	100	104	108	112	116	120	
FIANCHI	84	88	92	96	100	104	108	112	116	120	124	128	132	136	140	144	



CM.		MISURE BASE UOMO													
TAGLIE	P					M			G				SG		
	XSS	XS		S		M		L		XL		XXL		YL	
	40	42	44	46	48	50	52	54	56	58	60	62	64	66	68
TORACE	78-81	82-85	86-89	90-93	94-97	98-101	102-105	106-109	110-113	114-117	118-121	122-125	126-129	130-133	134-137
VITA	66	70	74	78	82	86	90	94	98	102	106	110	114	118	122
FIANCHI	78	82	86	90	94	98	102	106	110	114	118	122	126	130	134

CM.		MISURE BASE CAMICIE UOMO									
TAGLIE	XS	S	M	L	XL	XXL	YL	2YL			
	1	2	3	4	5	6	7	8			
		36	38	40	42	44	46	48	50	52	54
COLLO	36	38	40	42	44	46	48	50	52	54	

CM.		MISURE BASE PANTALONI UOMO UNISEX													
TAGLIE	XSS	XS		S		M		L		XL		XXL		YL	
	34	36	38	40	42	44	46	48	50	52	54	56	58	60	62
	VITA	68	72	76	80	84	88	92	96	100	104	108	112	116	120

garysworkwear.com

A group of five healthcare professionals, three women and two men, are running happily through a modern hospital hallway. They are wearing various colored scrubs: maroon, white, black, navy blue, and teal. The hallway has large windows on the left and a tiled floor. The overall atmosphere is bright and positive.

Happier Workplaces

INDICE dei tessuti

	PAG.		PAG.
JASPER		MAGLIA	
614100	109	100100	153
657400	109	102500	149
657500	108	102600	149
702600	117	102700	153
		102800	151
JEANS		102900	151
615400	116	103100	150
658500	116	103200	150
703800	179	103300	152
PEACH		POPELINE FINE	
615700	115	420000	217
658900	115	421000	217
702700	178	595100	155
704200	178	841500	154
		845100	155
X.LINEN			
617600	111	PIQUÉ	
662300	111	614000	144
704900	177	772500	173
EXTRAFIBER		VICHY	
616900	97	520000	190
661400	97	521000	189
702900	181	522000	193
704500	181	561200	187
		609300	192
STRETCH		647000	194
159700	163	648000	196
160100	159	652000	195
212300	163		
370100	163	OXFORD	
		612300	112
		613100	112
		656200	112
		656400	112
		702500	17

	PAG.		PAG.		PAG.		PAG.		PAG.
SERGE		SERGE		MICROFIBRA		MICROFIBRA		MICROFIBRA 360 VIGORÉ	
202100	209	610300 615800	130	445400	161	661100	74		
212900	204	615900	102	445500	161	661200	82	617800	60
213100	202	616100	101	445600	167	661300	83	662400	60
357100	133	616200	105	445700	167	661600	65	704600	180
400000	219	617300	106	447300	162/167	661800	45		
401000	219	617900	120	447400	162/167	662500	62	SATIN	
405000	219	618100	126	447600	166	662700	199		
405100	218	618200	121	447700	166	700600	172	203800	178
422000	217	623500	121	450800	158	702400	173	204000	178
435000	218	623600	142	450900	158	703700	176		
440000	218	650000	146	583600	161	704400	177	T400 TECHNOLOGY	
449100	218	657200	127	599100	51-53				
449600	219	659700	146	600100	161	MICROFIBRA ELASTIK		750200	225
530000	128	659800	102	609600	86/88				
531000	128	659900	101	609900	199				
532000	203	660600	104	611300	160	612900	67		
534000	123	661500	106	611400	21-30	613200	55	ALTRO	
540000	131	661700	123	611500	159	616700	56		
541000	132	661900	122	611700	51-53	656500	55	115000	210
542000	134	662600	120	612500	91	657300	66	121300	169
542100	134	662800	201	612600	93	658700	56	123000	211
543000	132	700500	126	613900	69	702800	176	124000	211
550000	222	700800	185	614800	163			125000	210
556000	147	704300	207	615200	33	MICROFIBRA 360		126100	213
558000	200	772000	107	615500	93			126200	212
570000	131	773000	185	615600	91	617500		126300	213
570100	206	773300	184	616300	70	617700	10	126400	215
570200	206	840000	184	616500	40/41	659600	17	126500	214
571000	128	841100	138	616600	43	662100	7	408000	219
575000	223	842000	138	616800	38	662200	14	410000	217
585000	220	843000	141	617100	77	704700	18	410100	217
601000	139	844000	138	617200	83	704800	174	415000	216
602000	141	772G00	141	655100	92		175	416000	214
603000	139	7733G0	138-182	655200	90			446100	219
604000	141	773G00	183	658100	69	MICROFIBRA RICICLATA		446200	219
605000	136		182	658400	34			449500	219
607200	125	SERGE ELASTICIZZATO		658600	43			450700	156
607300	124			658800	38	445800		486000	210
607400	119			659400	92	445900	167	486200	210
607700	130	703100		659500	90	611800	167	486300	156
608200	119	750100	185	660500	40/41	703600	47-49	595200	156
608300	207		227	660700	37		49	115ATO	210
610100	119			660800	71				
610200	124			660900	7				

La nostra azienda

Gary's Workwear fu creato nel 2001 dal suo attuale gestore nel piccolo paese di Vélez Rubio (Almería, Spagna). Puntare continuamente sull'innovazione e sulla qualità (sia nel servizio che nei materiali) ha portato l'azienda a una costante ricerca dell'eccellenza, ottenendo così materie prime di altissimo livello e uno straordinario team che lavora con impegno nell'azienda.

Nel 2019, dopo essersi affermata tra i leader del settore a livello nazionale e dopo anni di rapporti commerciali al di fuori della Spagna, inizia l'internazionalizzazione dell'azienda su vasta scala.

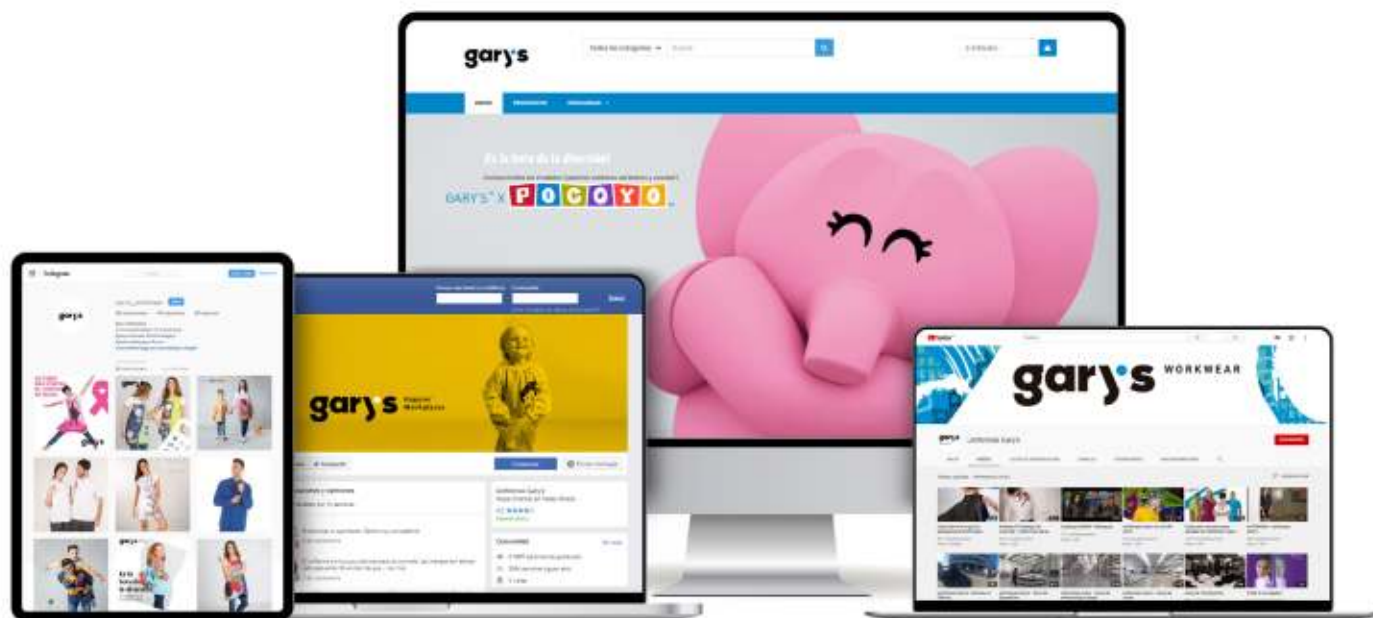

Seguici sui nostri social network



gary's Happier
Workplaces



FEDER

Fondo Europeo de Desarrollo Regional

Una manera de hacer Europa

UNIÓN EUROPEA

gary's Happier
Workplaces

©Uniformes Gary's

È proibita la riproduzione totale o parziale di questo catalogo, e il suo trattamento in qualsiasi modo o mediante qualsiasi mezzo senza il consenso scritto ed esplicito dell'azienda titolare del copyright.



8429935251936

garysworkwear.com